

A Comparative CFD study on Solar Dimple Plate Collector with Flat Plate Collector to Augment the Thermal Performance

Manjunath M.S, K. Vasudeva Karanth, and N. Yagnesh Sharma

Abstract—It is well known that surface enhancements play an important role in augmenting the thermal performance of flat plate solar collector. In this paper, an attempt is made to explain in a comparative way the effect of surface geometry of solar collector having dimple geometry with that of a flat plate solar collector of the same size. A CFD analysis was carried out for the two cases, subjected to a constant heat flux of 600W/m^2 and 1000W/m^2 . It can be inferred from the study that the absorber plate temperature shows a rise of average surface temperature of about 5°C for the dimple solar collector when compared to a flat plate solar collector. Most importantly, the average exit water temperature shows a marked improvement of about 5.5°C for a dimple solar collector as compared to that of a flat plate solar collector.

Keywords—CFD, Dimple-collector, Flat-plate-collector, Surface-enhancement, Thermal-Performance.

I. INTRODUCTION

SOLAR flat plate collectors have been in common use for both domestic and industrial purposes. This may be due to a simple design and low cost of maintenance of these collectors. Solar collectors are a special kind of heat exchangers that transform radiant energy from the sun to the internal energy of the transport media. However, flat plate solar collectors are associated with higher heat losses and hence lower thermal performance. A large number of research investigations have been undertaken both numerically and experimentally to enhance the thermal performance of flat plate solar collectors. Kumar and Rosen [2] investigated the thermal performance of an integrated solar water heater with a corrugated absorber plate. They found that the collector produced higher temperatures for longer time compared to the plain surface. Prasad [3] experimentally determined that the use of solar tracking in flat plate collectors can achieve 21% higher thermal efficiency. Gao et al [4] experimentally found that the cross-corrugated collectors have higher thermal performance as compared to simple flat plate collectors. V-groove collectors also have higher efficiency as reported by Karim et al [5]. Saini and Verma [6] used the concept of dimple shaped roughness geometry on the absorber plate to enhance surface area for heat absorption as well as to provide turbulence for air heating applications. Introducing turbulence in the water flow path is another way of enhancing the thermal

performance of solar collector. Kumar and Prasad [7] found that the use of twisted tape inserts significantly increases the thermal performance of solar water heater.

However, it is found that using a dimple flat plate solar collector to enhance the heat transfer rate is a new concept especially for water heating applications. In consideration of this it was decided to conduct a three dimensional conjugate CFD analysis on flat plates with and without dimple pockets to access their comparative thermal performance.

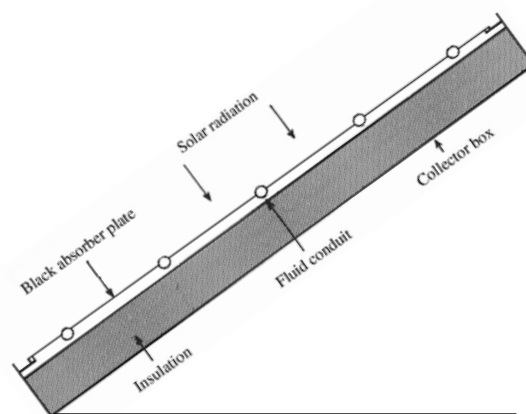

Fig. 1 Cross-sectional view of a solar flat plate collector system

II. NOMENCLATURE

T	Temperature
Q'	Heat flux
ρ	Density
μ	Viscosity
k	Thermal conductivity
Pr	Prandtl number
U	Velocity

III. NUMERICAL FORMULATIONS

A. Problem Statement and Assumptions

The computational domain consists of a flat absorber plate connected to a circular absorber tube as shown in Fig.1. The working fluid is water and is supplied at the inlet of the absorber tube. The collector system is inclined at 30° with respect to the horizontal. The following assumptions are made in the analysis:

N. Yagnesh Sharma, the Corresponding Author, is with the Manipal Institute of Technology, Manipal, University, Karnataka, India (phone: +91-9480485082; e-mail: nysharma@hotmail.com).

- 1) Water is a continuous medium and incompressible
- 2) The flow is steady and possesses laminar flow characteristics.
- 3) The thermo-physical properties of the absorber plate and absorber tube are constant with respect to the operating temperature.
- 4) The bottom portion of the absorber tube and bottom face of the absorber plate is assumed to be adiabatic.

B. Collector Configurations for the Analysis

In the first configuration, the collector system consists of a single absorber tube and a flat absorber plate. The absorber tube has a diameter of 0.01m and 0.001m thickness. The absorber plate has length and width of 1m and 0.12m respectively. The thickness of the absorber plate is 0.002m. The flat absorber plate configuration is as shown in Fig.2. In the second configuration, the flat absorber plate is replaced by a dimple absorber plate. Fig.3 and Fig.4 shows details of the dimple absorber plate used in the analysis.

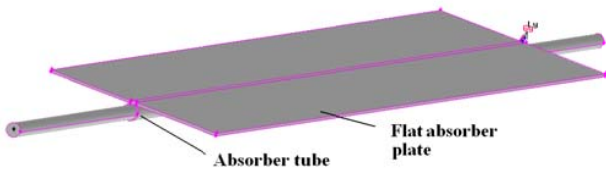

Fig. 2 Three dimensional model of a solar collector with flat absorber plate

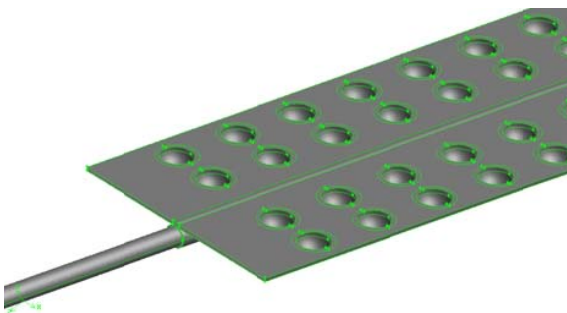

Fig. 3 Three dimensional model of a solar collector with dimple absorber plate

A. Numerical Model

The computational domain was modeled using the pre-processor routine called GAMBIT (version 2.4.6) and meshing was done using appropriate grid cells of suitable size available in the routine as shown in Fig. 5.

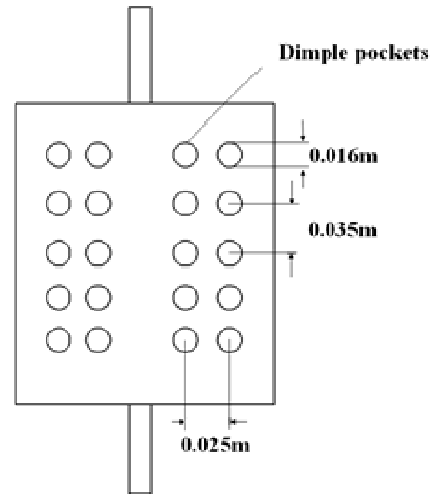

Fig. 4 Details of the dimple pockets on the absorber plate

Numerical simulation is carried out with steady implicit pressure based solver using the FLUENT 6.3 code. The governing partial differential equations for mass, momentum and energy are solved for the steady incompressible flows. The pressure-velocity coupling is carried out using SIMPLE algorithm [1]. Discretization is done using the second order upwind scheme.

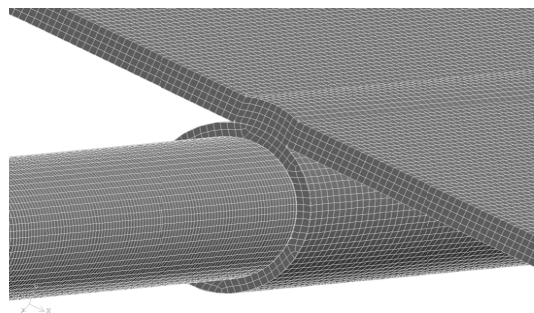

Fig. 5 Mesh of the computational domain

IV. MEAN FLOW EQUATIONS

The governing equations are presented in Cartesian tensor notation.

Continuity equation:

$$\frac{\partial}{\partial x_j} (\rho U_j) = 0 \tag{1}$$

Momentum equation:

$$\frac{\partial}{\partial x_j} (\rho U_i U_j) = \frac{\partial P}{\partial x_i} + \frac{\partial}{\partial x_j} \left[\mu \left(\frac{\partial U_i}{\partial x_j} + \frac{\partial U_j}{\partial x_i} \right) - \rho u_i u_j \right] \tag{2}$$

Energy equation:

$$\frac{\partial}{\partial x_j} (\rho U_j T) = \frac{\partial}{\partial x_j} \left[\frac{\mu}{Pr} \frac{\partial T}{\partial x_j} - \overline{\rho u_j T} \right] \quad (3)$$

V. METHOD OF SOLUTION

A. Numerical Scheme

Conservation equations were solved for the control volume to yield the velocity and temperature fields for the water flow in the absorber tube and the temperature fields for the absorber plate. Convergence was effected when all the residuals fell below 10^{-5} in the computational domain. Grid independence test was performed to check validity of the quality of mesh on the solution. The influence of further refinement did not change the result by more than 1.25% which is taken here as the appropriate mesh quality for computation.

B. Boundary Conditions and Operating Parameters

Mass flow inlet was specified at the inlet boundary condition and outflow was applied at the outlet. Velocity components were set to zero in accordance with the no-slip and impermeability conditions on the inner surface of absorber tube. Wall boundary conditions were used to bound fluid and solid regions. The interface between the water and the absorber tube is defined as wall with coupled condition to effect conjugate heat transfer from absorber tube to water. A constant heat flux equivalent to the solar insolation is applied at the top surface of the absorber plate. The material used for both absorber plate and absorber tube is copper. The input parameters used in the analysis are as shown in Table I.

TABLE I
INPUT PARAMETERS FOR SIMULATION

Parameter	Value
Density (Copper)	8978kg/m ³
Specific heat (Copper)	381J/kg-K
Thermal conductivity (Copper)	387.6W/m-K
Density (Water)	1000 kg/m ³
Viscosity (Water)	0.001003kg/(m-s)
Specific heat (Water)	4182J/kg-K
Thermal conductivity(Water)	0.6 W/m-K

VI. RESULTS AND DISCUSSIONS

The steady state temperature distribution along the absorber plates from inlet to exit is plotted to bring out the thermal performance of the collectors. Similarly, the steady state temperature rise of water in the absorber tube is also shown in the graphs given below. In Fig.6, a comparison is made of the absorber plate temperature for the case of dimple plate collector with the flat plate collector.

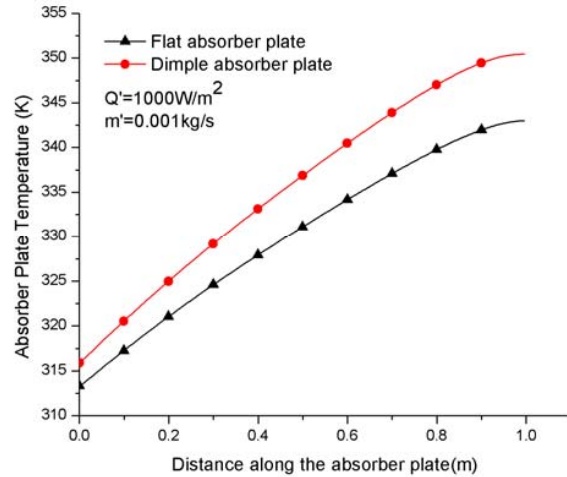

Fig. 6 Temperature distribution along the absorber plate

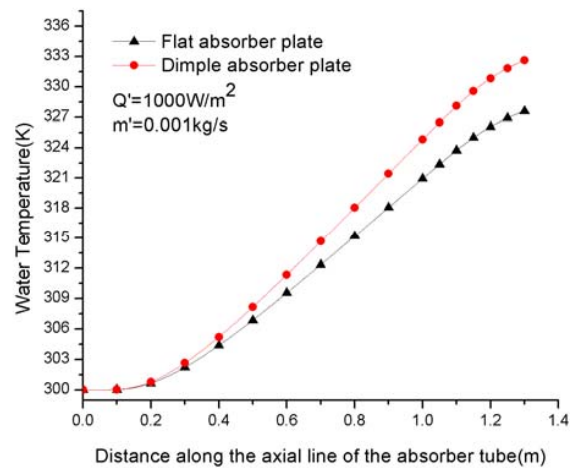

Fig. 7 Temperature distribution of water along the axial line of the absorber tube

It is clearly seen from the figure that there is a gradual temperature rise all along the length of the absorber plate. The temperature rise for the case of simulated constant solar heat flux of 1000W/m^2 is found to be about 2°C at the inlet to about 7.5°C at the exit of the absorber plate. It is clear that the enhanced dimple pocket geometry augments better heat transfer due to the increased contact surface area for the simulated constant solar heat flux.

Similarly, the temperature rise of the water with and without dimple collector is shown in Fig. 7. It is easily seen that there is augmented heating up of water in the absorber tube of the dimpled plate collector than the absorber tube of the flat plate collector along the axial line of the absorber tube. For the specific case of simulated constant solar heat flux of 1000W/m^2 , the useful working temperature rise by about 5°C .

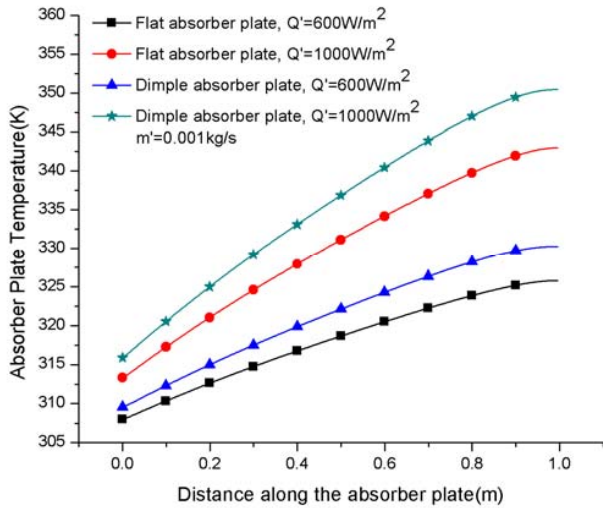

Fig. 8 Temperature distribution along the absorber plate for flat plate and dimple plate for different heat flux

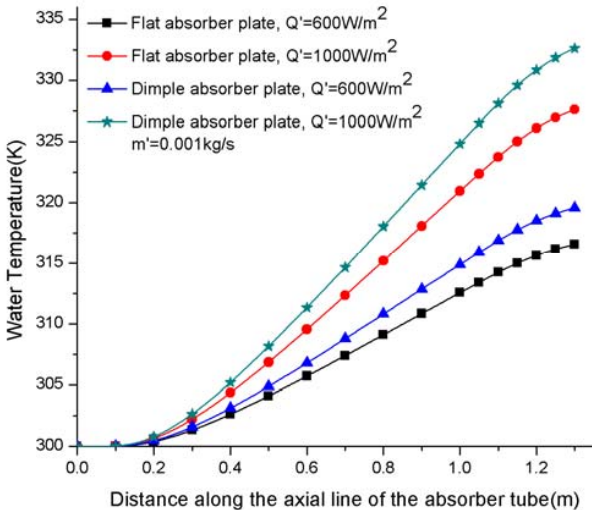

Fig. 9 Temperature distribution along the axial line of the absorber tube for flat plate and dimple plate for different heat flux

In Fig.8, the effect of different cases of uniform heat fluxes is compared for dimple and flat plate collector. It is seen that the phenomenon explained earlier is true for all the different cases of heat fluxes. It is interesting to note that the quantum of rise in temperature for a given heat flux is the same indicating that irrespective of the heat flux value, the behavior of the dimple collector remains the same with respect to the flat plate collector.

Similarly, from Fig.9, it can be deduced that the water in the absorber tube get heated in the same manner for the cases of dimple and flat plate collectors again indicating that the quantum of temperature rise in the absorber tubes is irrespective of the simulated constant solar heat flux.

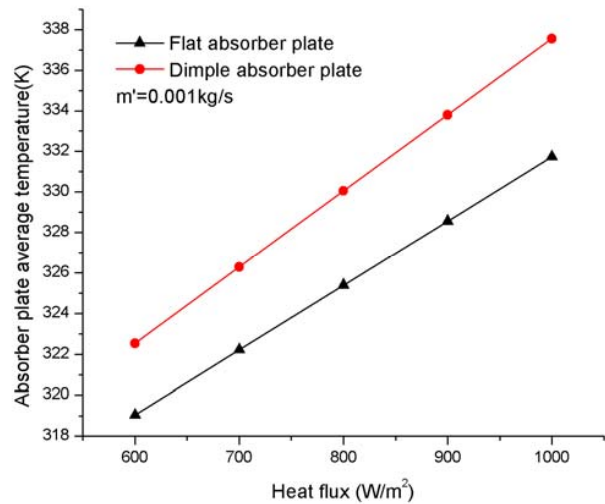

Fig. 10 Comparison of average temperature of absorber plate for flat plate and dimple plate collectors

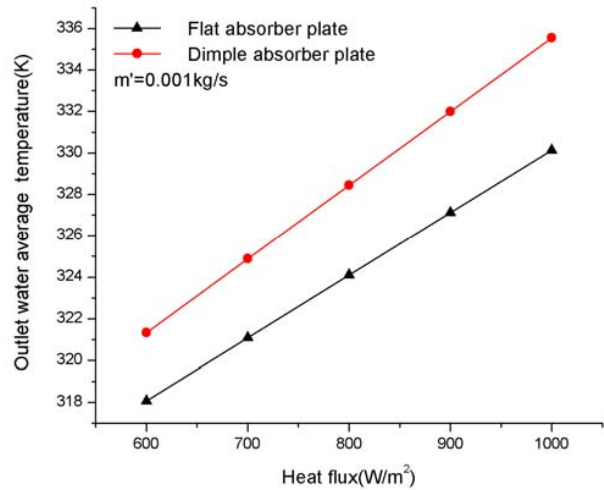

Fig. 11 Comparison of average temperature of outlet water for flat plate and dimple plate collectors

Fig.10 shows average absorber surface temperature characteristics with respect to the heat flux and is found to be linear for both the cases of dimple and flat absorber plates. But, it is interesting to note that there is a significant but almost uniform rise in the average surface temperature of the dimple absorber plate compared to the flat absorber plate again indicating the efficacy of using a dimple flat plate collector for thermal performance enhancement.

Fig.11 shows an average exit temperature of water in the absorber tube of dimple and flat plate collectors. It is clearly seen that again there is an almost uniform temperature rise of the water at the exit for different cases of simulated constant solar heat flux inputs.

The temperature contour plots for the cases of dimple geometry and flat plate geometry are shown in Fig.12 and Fig. 13. It is seen that there is relatively larger surface area having higher temperature region for a dimple solar flat collector than

for flat plate collector. The difference in the color band is about 8°C corresponding to the highest heat flux of 1000W/m² for each case.

Similarly, the temperature contours along the flow path of the absorber tube is shown in the cross sectional views in Fig.14 and Fig.15. It is clear that there is a significant

augmentation of heat transfer by a dimple collector as can be seen with a relatively rapid rise in temperature of the flowing medium inside the tube.

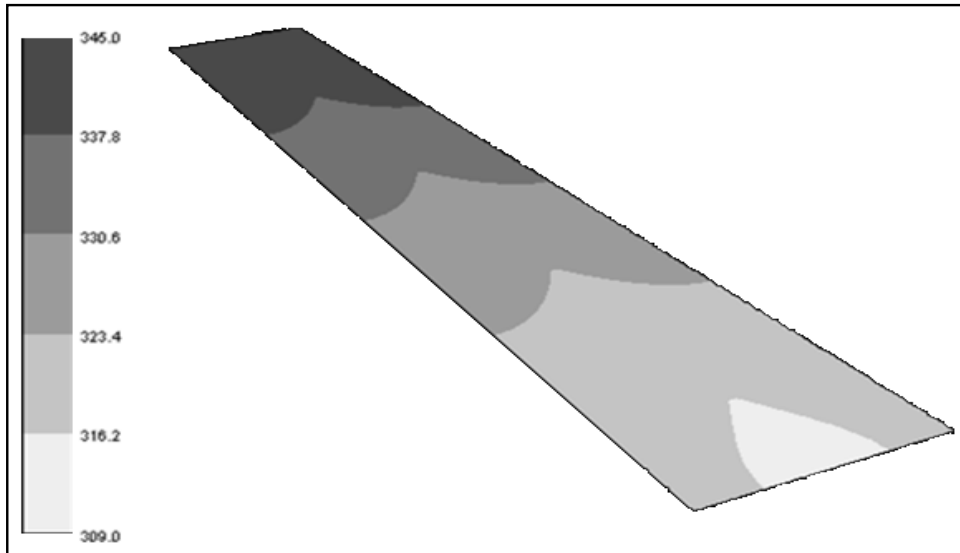

Fig. 12 Temperature contours of absorber plate for flat plate collector at 1000W/m²

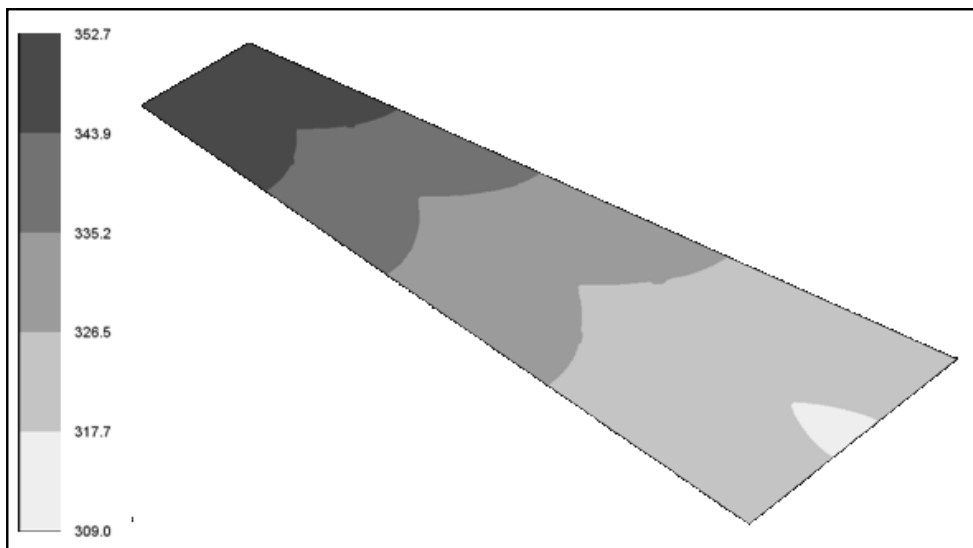

Fig. 13 Temperature contours of absorber plate for dimple plate collector at 1000W/m²

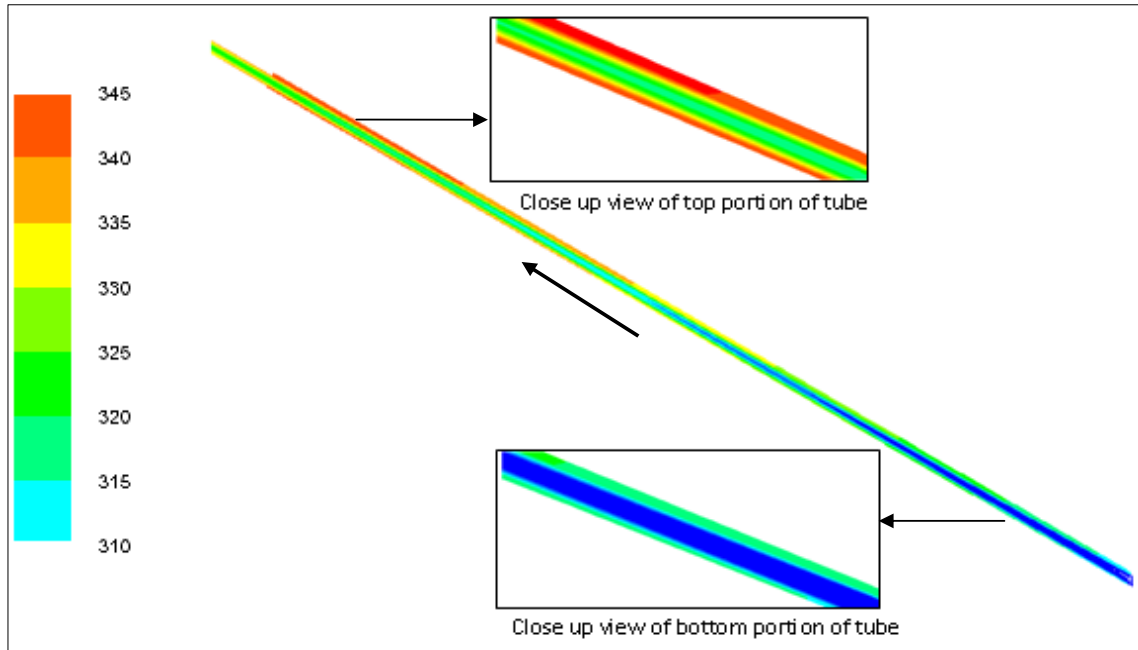

Fig. 14 Temperature contours of water along the axial line of the absorber tube of flat plate collector at 1000W/m^2

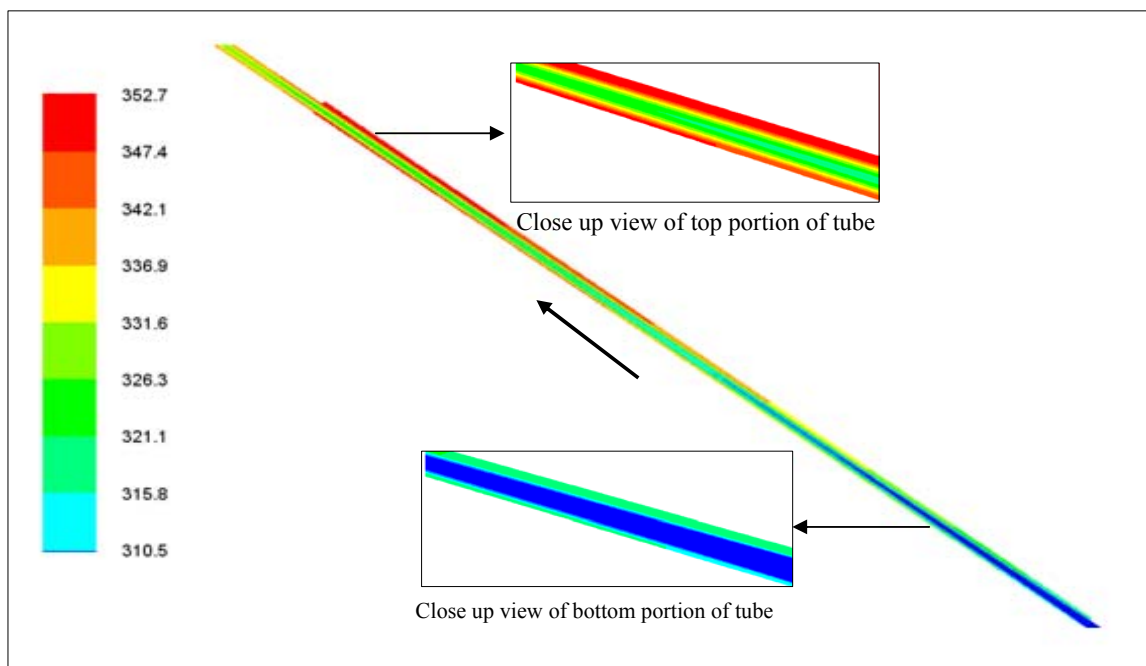

Fig. 15 Temperature contours of water along the axial line of the absorber tube of dimple plate collector at 1000W/m^2

VII. CONCLUSION

From the CFD analysis carried for the full three dimensional absorber plate assemblies for plates with and without dimple establishes that with surface geometry enhancements such as having a dimple pocket increases the heat transfer to the absorber tube due mainly to the increase in area for diffusion heat transfer.

ACKNOWLEDGMENT

The third author wishes to gratefully acknowledge the financial support extended by the Manipal University, Manipal, India for sponsoring him to this conference. The computational facilities were extended by the Department of Mechanical and Manufacturing Engineering, Manipal Institute of Technology, Manipal, which is thankfully acknowledged.

REFERENCES

- [1] Patankar S. V. and Spalding D.B, "A calculation procedure for heat, mass and momentum transfer in three dimensional parabolic flows", *Int. Journal of Heat Mass Transfer*, vol 15, 1972, pp. 1787.
- [2] Kumar R and Rosen M.A," Thermal performance of integrated collector storage solar water heater with corrugated absorber surface", *Applied Thermal Engineering*,2010, pp. 1-5.
- [3] Prasad P.R and Bryegowda H.V and Gangavati P.B, "Experimental analysis of flat plate collector and comparison of performance with tracking collector", *European Journal of Scientific Research*, vol. 40(1), 2010, pp. 144–155.
- [4] Gao W, Lin W, Liu T and Xia C," Analytical and experimental studies on the thermal performance of cross-corrugated and flat plate solar air heaters", *Applied Energy*, vol. 84, 2007, pp. 425-441.
- [5] Karim A and Hawlader M.N.A, "Performance investigation of flat plate, v-corrugated and finned air collectors", *Energy*, vol. 312004, pp. 452-470.
- [6] Saini M and Verma J,"Heat transfer and friction correlations for a duct having dimple shaped artificial roughness for solar air heaters", *Energy*, vol. 33, 2008, pp. 1277-1287.
- [7] Kumar A and Prasad B.N," Investigation of twisted tape inserted solar water heaters- heat transfer, friction factor and thermal performance results", *Renewable Energy*, vol. 19, 2010, pp. 379-398.
- [8] FLUENT 6.3 users guide, Volume I to IV.

N. Yagnesh Sharma is a senior Professor in the Department of Mechanical and Manufacturing Engineering, Manipal Institute of Technology, Manipal University, Manipal, India, and specializes in the areas of CFD, combustion studies and solar energy. He has about 50 technical articles in leading journals, international and national conferences. He has supervised so far two PhD scholars and five more research scholars are working towards their doctoral work under his guidance.

K. Vasudeva Karanth is a Professor in the Department of Mechanical and Manufacturing Engineering, Manipal Institute of Technology, Manipal University, Manipal, India. He has core competency in fluid flow modeling and analysis of turbo-machinery and solar energy. He has published about 22 technical articles in leading journals, international and national conferences. He is guiding two research scholars towards their PhD degree.

Manjunath M.S. is an Assistant Professor in the Department of Mechanical and Manufacturing Engineering, Manipal Institute of Technology, Manipal University, Manipal, India. He is working towards his PhD in the area of thermal performance of various types of solar collectors.