

Parameter Determination of a Vehicle 5-DOF Model to Simulate Occupant Deceleration in a Frontal Crash

Javad Marzbanrad, Mostafa Pahlavani

Abstract—This study has investigated a vehicle Lumped Parameter Model (LPM) in frontal crash. There are several ways for determining spring and damper characteristics and type of problem shall be considered as system identification. This study use Genetic Algorithm (GA) procedure, being an effective procedure in case of optimization issues, for optimizing errors, between target data (experimental data) and calculated results (being obtained by analytical solving). In this study analyzed model in 5-DOF then compared our results with 5-DOF serial model. Finally, the response of model due to external excitement is investigated.

Keywords—Vehicle, Lumped-Parameter Model, Genetic Algorithm, Optimization

I. INTRODUCTION

HISTORICALLY, those considerations about the manner of decorating materials and necessities about physical structure of vehicle have resulted in designing structure and its body. Generally, final design of a vehicle is the product of a long term process, being derived by several tests and supported by simple linear stiffness ways. By developing software and hardware, it is possible to use more analytical facilities, making several tools, for analytical designing modern structure of vehicle. Therefore, engineers are able to meet their growing needs and better performance of crashworthiness and safe driving. These tools include lumped parameters models (LPMs), Beam element models, hybrid models and finite elements models (FE).

In 1970, Kamal [1] presented a simple and strong model for simulation of crashworthiness in frontal crash. As, providing acceptable results, data was used by crash engineers, widely. Note, spring characteristics were experimentally determined in static damper.

Also in 1988, Magee [2] presented a model from crashing with barrier. This study used actual crashes information, for determining properties of springs, masses and breaking models. This model has been designed with considering the properties of load-moving springs, for obtaining best consistency of accelerations, its peak and crash scheduling. Cheva et al. [3] presents a one dimensional lumped mass

J. Marzbanrad is associate professor in the School of Automotive Engineering, Iran University of Science and Technology, 16846-13114, Tehran, Iran (corresponding author to provide phone: +98-21-77240-3981; fax: +98 21 73228981; E-mail: marzban@iust.ac.ir), Tehran, Iran.

M. Pahlavani is MS graduate of Iran University of Science and Technology, Tehran, Iran. He is now teaching some courses in Automotive fields. (E-mail: pahlavani.s@gmail.com).

model. This used simulations of finite elements, for determining spring properties. Also, recorded normalized acceleration in test and simulation of lumped mass have had desired consistency with each other.

Alexandra et al. [4] has presented a lumped mass model in frontal/offset crash, in national Highway Traffic Safety Administration (NHTSA), being directly extracted structural properties of vehicle from data, related into crash test.

Except finite element models, being time consuming and difficult, hybrid models of finite element and Lumped mass models are paid attention by analysts and designer, such as Hollowell research, in 1986 [5, 6]. In 1986, Ni and Song [7] described 3 methods for simulating vehicle structures in crashes.

In 2008, Deb and Srinivas [8] focused on lumped mass model in side crash, presenting a simple and comprehensive model. Their studies were performed, on the basis of attracted energies comparisons, in inside impact of cart and vehicle and lumped mass model with obtained results, from finite element simulations.

This study presents a simple and comprehensive model with linear spring and damper, for modeling a frontal crash. Also, it shall consider differences of deceleration's peak and deceleration on occupant. It is necessary to use damper, because of measuring amount of vehicle structure damping, being made by existing injecting foams.

II. EQUATION AND ANALYZING SOLUTION ALGORITHM

For approving this kind of algorithm and solution, we compared the analytical solution of system equation of movement in 2 degree of freedom and comparing parameters optimizations with its results.

By assuming system, in figure 4, the model equation of motion shall be equal to Equation 1.

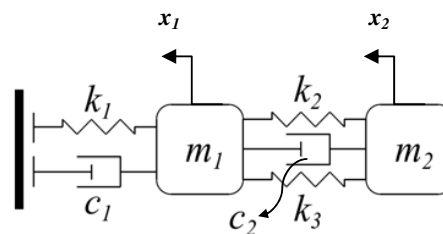

Fig. 1 Two degree of freedom model

$$\begin{cases} m_1\ddot{x}_1 + (c_1 + c_2)\dot{x}_1 - c_2\dot{x}_2 + (k_1 + k_2 + k_3)x_1 - (k_2 + k_3)x_2 = 0 \\ m_2\ddot{x}_2 - c_2\dot{x}_1 + c_2\dot{x}_2 - (k_2 + k_3)x_1 + (k_2 + k_3)x_2 = 0 \end{cases} \quad (1)$$

The initial conditions are $x_1 = x_2 = 0$ and $\dot{x}_1 = \dot{x}_2 = 14$. Equation 1 may be written in the matrix form as follows:

$$M \begin{Bmatrix} \ddot{x}_1 \\ \ddot{x}_2 \end{Bmatrix} + C \begin{Bmatrix} \dot{x}_1 \\ \dot{x}_2 \end{Bmatrix} + K \begin{Bmatrix} x_1 \\ x_2 \end{Bmatrix} = \begin{Bmatrix} 0 \\ 0 \end{Bmatrix} \quad (2)$$

where:

$$M = \begin{bmatrix} m_1 & 0 \\ 0 & m_2 \end{bmatrix}, \quad C = \begin{bmatrix} c_1 + c_2 & -c_2 \\ -c_2 & c_2 \end{bmatrix}, \quad K = \begin{bmatrix} k_1 + k_2 + k_3 & -k_2 - k_3 \\ -k_2 - k_3 & k_2 + k_3 \end{bmatrix} \quad (3)$$

It may be possible to change the tow order differential Equation (1) to state space from as following:

$$\dot{X} = AX + Bu \quad (4)$$

$$Y = HX + Du$$

Here:

$$A = \begin{bmatrix} 0 & 0 & 1 & 0 \\ 0 & 0 & 0 & 1 \\ -(K_1 + K_2 + K_3)/m_1 & (K_2 + K_3)/m_1 & -(c_1 + c_2)/m_1 & +c_2/m_2 \\ (K_2 + K_3)/m_2 & -(K_2 + K_3)/m_2 & +c_2/m_2 & -c_2/m_2 \end{bmatrix} \quad (5)$$

$$B = \begin{bmatrix} 0 \\ 0 \\ 0 \\ 0 \end{bmatrix}, \quad H = \begin{bmatrix} 1 & 0 & 0 & 0 \\ 0 & 1 & 0 & 0 \\ 0 & 0 & 1 & 0 \\ 0 & 0 & 0 & 1 \end{bmatrix}, \quad D = \begin{bmatrix} 0 \\ 0 \\ 0 \\ 0 \end{bmatrix}$$

It is also can rewrite the equations as below to generalize the formation:

$$A = \begin{bmatrix} [0]_{2 \times 2} & [I]_{2 \times 2} \\ -[M]^{-1}[K] & -[M]^{-1}[C] \end{bmatrix}, \quad B = [0]_{2 \times 1}, \quad H = [I]_{2 \times 2 \times 2 \times 1}, \quad D = [0]_{2 \times 1} \quad (6)$$

The following values were used in this part for simulation: $m_1=800kg$, $m_2=80kg$, $c_1=10000N.s/m$, $c_2=1100N.s/m$, $k_1=1000N/m$, $k_2=160N/m$ and $k_3=2700N/m$.

The main reason of considering k_1 and k_3 in parallel way is testing the state of optimization in 2 cases. The first, we have $k_2+k_3=constant$; it means k_2 and k_3 have any amounts in above mentioned condition, on the other hand, it is anticipated that $k_2=k_3=1430$. In this case, decision variables are c_1 , c_2 , k_1 , k_2 and k_3 . Also, active parameters such as $m_1=800kg$ and $m_2=80kg$, were considered as vehicle and occupant masses, respectively.

The second, according to being parallel of springs and similarity of k_3 as a coefficient of k_2 , it must be considered the rate of $k_2=16.875k_3$ of solution condition. In this case, decision variables are c_1 , c_2 , k_1 and k_2 . m_1 and m_2 are as same as last case that was discussed about it.

The function attempts to find the constrained minimum of a scalar function of several variables. A typical problem can be formulated as:

$$\min f(\theta) \quad (7)$$

where “ θ ” denotes the unknown design variables, which, in this case are the masses, damping and stiffness constants in the model. The cost function $f(\theta)$ is referred to objective function, which is to be optimized. In this study, the cost function is the Root Mean Square (RMS) of differences between the measured and calculated deceleration for the load cases. The Genetic Algorithm is used for optimization of cost function. The aim is to minimize the cost function value. The cost function is defined as:

$$Z = RMS(ea / \text{mean}(\text{abs}(a_{exp}))) \quad (8)$$

where “ $mean$ ” is average of data and “ ea ” can be represented as follows:

$$ea = a_i - a_{exp} \quad (9)$$

that “ ea ” is the deceleration error that is calculated by difference between i th mass deceleration and target deceleration (a_{exp}) which obtained from experimental tests.

The results of optimization after 2000 iteration with random initial population are shown in Tables I and II.

TABLE I
OPTIMIZATION RESULTS OF 2-DOF MODEL IN STATE $k_2+k_3=CONSTANT$.

Method	c_1 (N.s/m)	c_2 (N.s/m)	k_1 (N/m)	k_2 (N/m)	k_3 (N/m)
Analytical ^a	10000	1100	1000	160	2700
Optimization	10004.9	1099.8	1033.4	1438.8	1418.5
Error %	0.05	-0.01	3.34	799.26	-47.48
k_2+k_3 Error %					-0.11

a. Parameters are assumed as active.

TABLE II
OPTIMIZATION RESULTS OF 2-DOF MODEL IN STATE $k_2=16.785k_3$.

Method	c_1 (N.s/m)	c_2 (N.s/m)	k_1 (N/m)	k_2 (N/m)
Analytical ^a	10000	1100	1000	160
Optimization	10011.91	1098.79	992.91	159.63
Error %	0.12	-0.11	-0.71	-0.23

a. Parameters are assumed as active.

The previous algorithm for optimization method is used here to calculate the spring and damper coefficient. Time history of deceleration is shown in Figure 4.

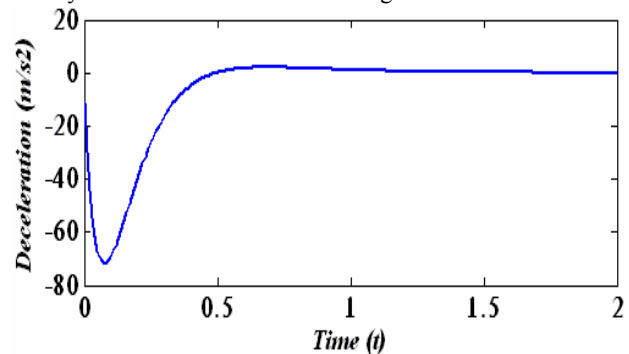

Fig. 2 Deceleration on m_2 in 2 degree of freedom model obtained from analytical solution

Time history of error values shows the differences between deceleration of m_2 in analytical and optimization solution which is occurred after 2000 iteration. It is illustrated in Figures 5 and 6. As one can see in these Figures, in both cases ($k_2+k_3=constant$ and $k_2=16.875k_3$) deceleration error of m_2 under the worse conditions is less than $0.02m/s^2$ which is considered as 0.28% error equals to max deceleration of $71.44m/s^2$.

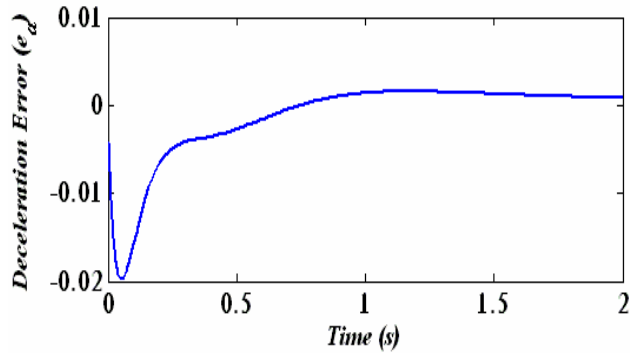

Fig. 3 Error of deceleration on m_2 in 2 degree of freedom model obtained from optimization under $k_2+k_3=constant$

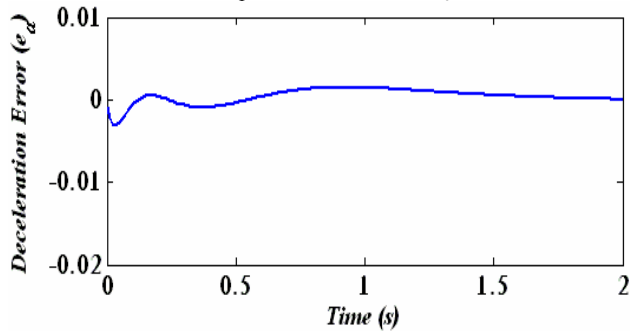

Fig. 4 Error of deceleration on m_2 in 2 degree of freedom model resulted from optimization under $k_2=16/875k_3$

The obtained optimized values indicate that they are acceptably close to accurate parameters after enough iteration, so it can solve complex models. We should consider that amount of corresponding between desired and target deceleration depends on degree of freedom. So, solution algorithm will be designed in such way which will be stopped after 500 iterations with equal value of cost function that is assumed 0.1 as its limit. Figure 7 shows procedure of solving problem.

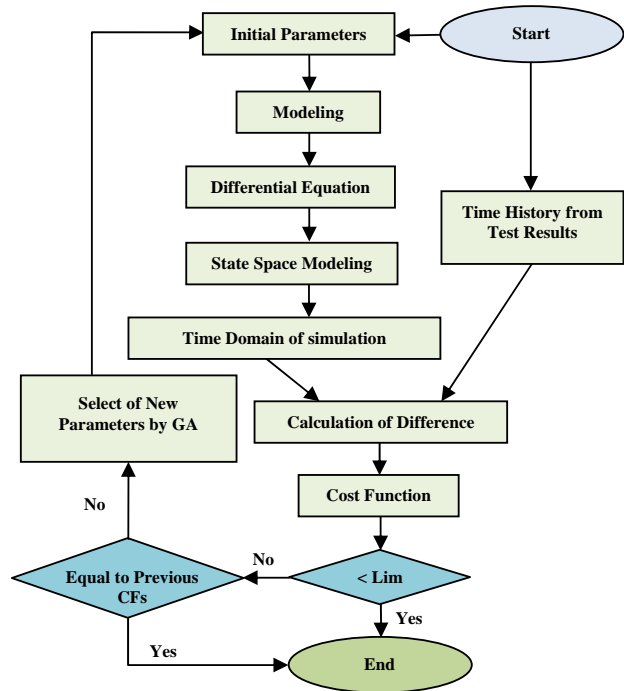

Fig. 5 Algorithm of problem solving

III. 5-DOF MODELING AND RESULTS

In this section, a 5-DOF model is analyzed as a vehicle in crash and the spring and damper specifications are determined by using the optimization algorithm as indicated in Figure 7. In completion of Kamal's model, we analyzed this model in 5 degree of freedom which shown in Figure 8 and then compared our results with 5-DOF serial model as Figure 9. Tables III and IV are show proportions of lumped parameters.

TABLE III
MASS PROPORTION FOR 5-DOF SERIAL MODEL

Serial Model Mass No.	Lumped Components	Mass (kg)
m_1	Radiator	50
m_2	Suspension and Lower Longitudinal Structural Elements	100
m_3	Engine and Upper Longitudinal Structural Elements	300
m_4	Fire Wall and Part of Body on Its Back	820
m_5	Occupant	80

TABLE IV
MASS PROPORTION FOR 5-DOF LH MODEL

LH Model Mass No.	Lumped Components	Mass (kg)
m_1	Engine and Radiator	300
m_2	Suspension and Lower Longitudinal Structural Elements	120
m_3	Engine Cradle and Upper Longitudinal Structural Elements	150
m_4	Fire Wall and Part of Body on Its Back	700
m_5	Occupant	80

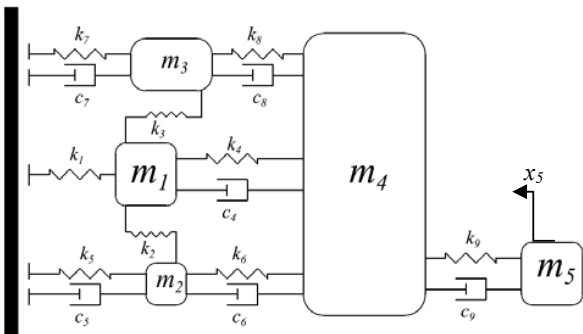

Fig. 6 5-DOF LH model

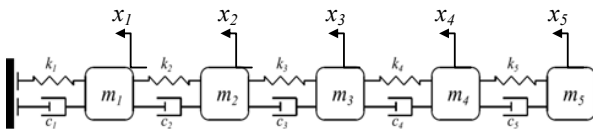

Fig. 7 5-DOF serial model

In this research, the occupant deceleration of a Dodge Neon vehicle test is used as the goal data to be criteria for optimization. The results obtained and compared here and proposed in Figure 10 to 13. Figures 10 and 11 are for 5-DOF LH model and Figures 12 and 13 are for 5-DOF serial model.

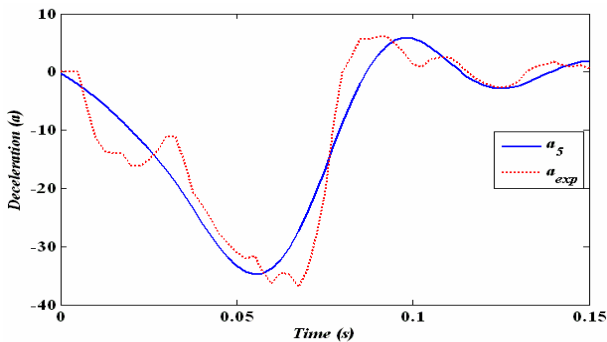

Fig. 8 Optimized (a_5) and experimental (a_{exp}) results for deceleration in 5-DOF LH model

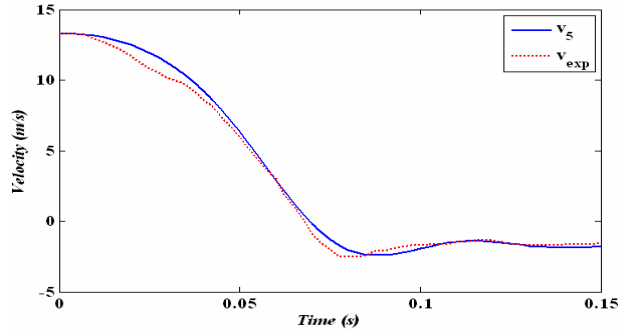

Fig. 9 Optimized (v_5) and experimental (v_{exp}) results for velocity in 5-DOF LH model

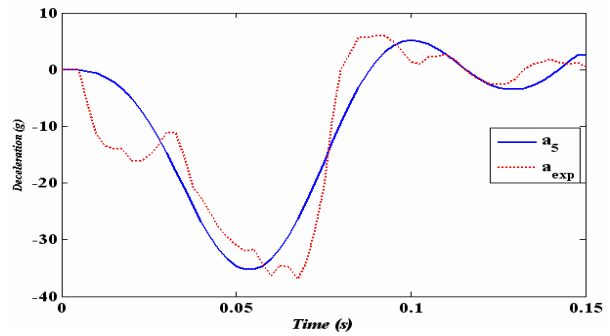

Fig. 10 Optimized (a_5) and experimental (a_{exp}) results for deceleration in 5-DOF serial model

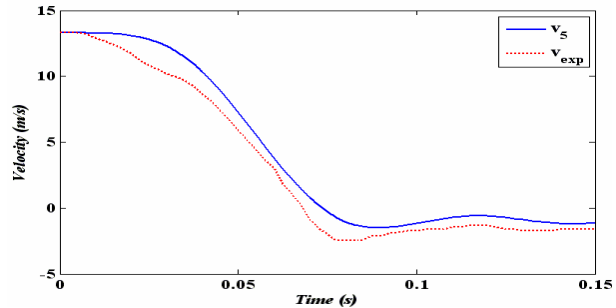

Fig. 11 Optimized (v_5) and experimental (v_{exp}) results for velocity in 5-DOF serial model

IV. COMPARISON BETWEEN TWO MODELS

In Table V, we present final Root Mean Square of deceleration error, and maximum deceleration error in four models and also presented final Root Mean Square of velocity error and maximum velocity error in Table 6.

TABLE V
COMPARISON BETWEEN DECELERATION ERRORS OF FOUR MODELS.

Error	Final Root Mean Square of Deceleration Error (g)	Maximum Deceleration Error (g)
5 DOF LH	4.1624	9.77
5 DOF Serial	5.3902	12.24

TABLE VI
COMPARISON BETWEEN DECELERATION ERRORS OF FOUR MODELS.

Model	Final Root Mean Square of Velocity Error (m/s)	Maximum Velocity Error (m/s)
5 DOF LH	0.4621	1.154
5 DOF Serial	1.1346	2.072

Figure 10 dates reveals those responses of occupant deceleration in both 5-DOF LH and Serial models are same and follows from experimental test data reasonably. In Figure 11 dates, we founded that error of LH model deceleration is lower than of Serial model. Figures 12 and 13 reveal time history of velocity and velocity error in both 5-DOF models. Parameters value of both models presented in Table 7.

TABLE VII
VALUE OF PARAMETERS OF BOTH MODELS

Parameter	LH Model	Serial Model
c ₁	-	19919388.21
c ₂	-	19917598.56
c ₃	-	0.18304
c ₄	0.8981	19777.1246
c ₅	33114.21	810.8301
c ₆	1.7284	-
c ₇	6764.6574	-
c ₈	8648277.61	-
c ₉	1595.52	-
k ₁	48.8660	1341925.08
k ₂	915522.58	1333105.21
k ₃	1206875.43	1117990.69
k ₄	1178694.84	1.91805
k ₅	36.7265	572047.24
k ₆	136.4661	-
k ₇	38.6678	-
k ₈	4761249.39	-
k ₉	389232.42	-

V. MODEL WITH EXCITATION

As in the lumped parameters model, the effect of external excitation has an important role [9], it will be suitable to see its effects on the 5-DOF with the determined parameters in section 4. Figure 12 shows the detail of such model with external excitation.

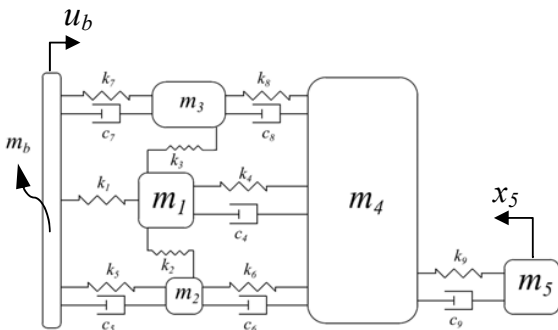

Fig. 12 5-DOF LH model with external excitation

In this calculation, to avoid any change in the mass matrix and large value in the force coefficient (P₀), it is considered: m_b=1kg.

Excitation forces are considered here as sin and cosine functions and also a combination of them as expressed in Equation (10) to Equation (12); where Equation (12) has two excitation frequencies.

$$u_b = -P_0 \times \sin(\omega t)$$

$$10000 < P_0 < 50000$$

$$0 < \omega < 200$$
(10)

$$u_b = -P_0 \times (1 - \cos(\omega t))$$

$$1000 < P_0 < 50000$$

$$0 < \omega < 200$$
(11)

$$u_b = -P_0 \times |\sin(\omega_1 t) + \frac{1}{2}(1 - \cos(2\omega_2 t))|$$

$$P_0 = 50000$$

$$0 < \omega_1 < 100$$

$$0 < \omega_2 < 100$$
(12)

The effect of sin force may be observed in Figure 13. This figure shows absolute average of deceleration applied to mass 5 with respect to constant coefficient of force (P₀) and excited frequency (ω).

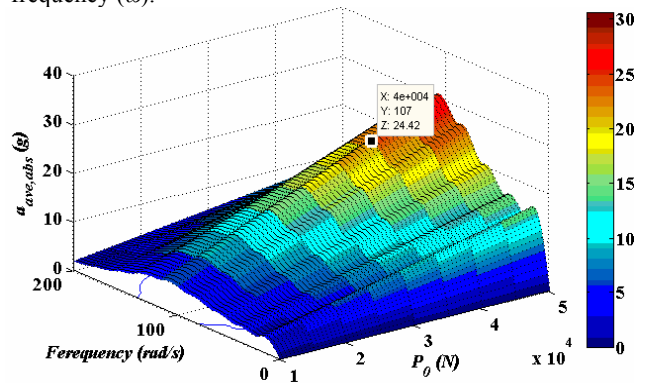

Fig. 13 Absolute average of deceleration of occupant submitted to sin excitation for Dodge Neon

It is obvious that the deceleration has linear proportional to P₀ and increases when P₀ increases. However, mass 5 will experience most deceleration in excited frequency of 107rad/sec.

Again, Figure 14 illustrates the result of maximum absolute average of mass deceleration 5 with respect to P₀ and ω when cosine excitation applied to the system. Mass 5 has maximum value in the excited frequency 120rad/sec.

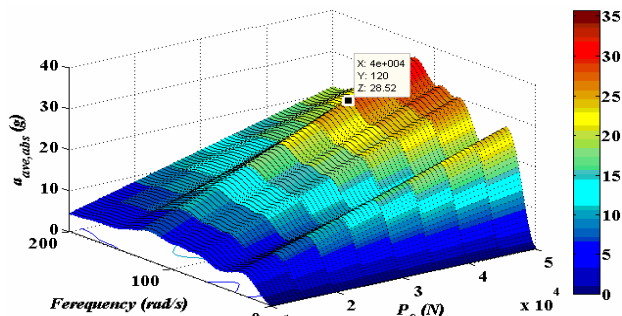

Fig. 14 Absolute average of deceleration of occupant submitted to cosine excitation for Dodge Neon

Figure 15 shows the absolute average of deceleration of mass 5 submitted to combined excitation with two frequencies. The maximum value occurs in the excited frequencies $\omega_1=62\text{rad/sec}$ and $\omega_2=53\text{rad/sec}$.

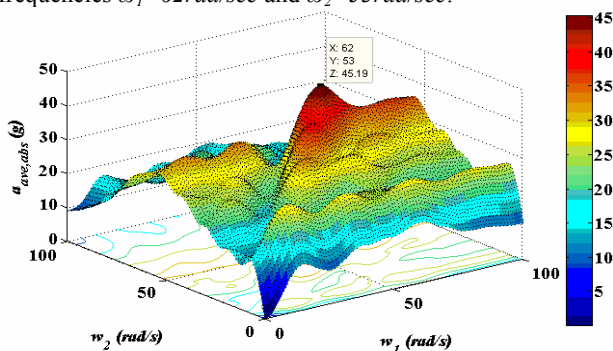

Fig. 15 Absolute average of deceleration of occupant submitted to combination excitation for Dodge Neon

VI. CONCLUSION

An algorithm has been presented to evaluate a 5-DOF serial model in the field of deceleration and velocity. The results have been compared to experimental data. It is concluded that the deceleration error with along velocity error of test results may be used to make a suitable lumped model in frontal crash.

The following notes considered in this regard:

- Number of DOF should be considered accurately, as it yields deturgency in some situations.
- Spring arrangement is an important item although with the same model.
- Whereas force-displacement behavior of components is not available in optimization, algorithm could set one or more parameter too little, so it doesn't make the solution wrong as some parameters may be extra.

In conclusion, the lumped model presented here gives accurate occupant deceleration enough to represent the car dynamic behavior during frontal crash. However, more DOF may be required to capture the behavior of other car types.

A continuation of the current work will include coupling of model parameters in a more DOF; i.e. divide the global car to the smaller parts. This will provide information on how the model parameters shall be adjusted based on information from experimental test of vehicle crash.

REFERENCES

- [1] M. M. Kamal, "Analysis and simulation of vehicle to barrier impact". SAE paper 700414, 1970.
- [2] C. L. Magee, "Design for crash energy management present and future developments". In Proceedings of the Seventh International Conference on Vehicle structural mechanics, Detroit, Michigan, USA, SAE International, Warrendale, Pennsylvania, 1988.
- [3] W. Cheva, T. Yasuki, V. Gupta, and K. Mendis, "Vehicle development for frontal/offset crash using lumped parameter modeling". SAE paper 960437, 1996.
- [4] C. C. Alexandra, G. M. Stuart, and R. R. Samaha, "Lumped parameter modelling of frontal offset impacts". SAE paper 950651, 1995.
- [5] W. T. Hollowell, "Adaptive time domain, constrained system identification of nonlinear structures". Symposium on Vehicle Crashworthiness Including Impact Biomechanics, AMD-Vol. 79/BED-Vol. 1, pp. 105-123, ASME, 1986.
- [6] W. T. Hollowell, "Adaptive time domain, constrained system identification of nonlinear structures". Doctorate Dissertation, The University of Virginia, Charlottesville, VA, 1986.
- [7] C. M. Ni, and J. O. Song, "Computer-aided design analysis methods for vehicle structural crashworthiness". In: Proc. of Symposium on Vehicle Crashworthiness Including Impact Biomechanics AMD-Vol. 79/BED-Vol. 1, pp. 125-139, ASME, 1986.
- [8] A. Deb, and K. C. Srinivas, "Development of a new lumped-parameter model for vehicle side-impact safety simulation". Journal of Automobile Engineering. Vol. 222, pp.1793-1811, 2008.
- [9] Huang, M., "Vehicle Crash Mechanics". 2nd Edition, SAE International, CRC Press, 2002.

Javad Marzbanrad is an associate professor in Automotive Engineering at Iran University of Science and Technology. He was born in 1964 in Tehran, Iran. He got his Ph.D's Degree in 2001 from Tarbiat Modarres University. He was in the Clarkson University, NY, U.S. in 2000-01 as visiting scholar. His research interests are Automotive, Control and Vibration and Solid Mechanics. Now, he is the faculty of School of Automotive Engineering in Iran University of Science and Technology. He has more than 150 published papers in the conferences and journals. He also published three books in mechanical software fields. He has also registered six inventions in Iran.

Mostafa Pahlavani teaches in University of Applied Science (Niroo-Mohareke Branch) and Payam Noor University (Qazvin Branch) in the field of vehicle mechanics. He was born in 1983 in Rasht, Iran. He got his Master's Degree in 2011 from Iran University of Science and Technology, School of Automotive Engineering. His research interests are body and structure and design fields in Automotives.