

Development of a 3D Mathematical Model for a Doxorubicin Controlled Release System using Pluronic Gel for Breast Cancer Treatment

W. Kaowumpai, D. Koolpiruck, and K. Viravaidya

Abstract—Female breast cancer is the second in frequency after cervical cancer. Surgery is the most common treatment for breast cancer, followed by chemotherapy as a treatment of choice. Although effective, it causes serious side effects. Controlled-release drug delivery is an alternative method to improve the efficacy and safety of the treatment. It can release the dosage of drug between the minimum effect concentration (MEC) and minimum toxic concentration (MTC) within tumor tissue and reduce the damage of normal tissue and the side effect. Because an in vivo experiment of this system can be time-consuming and labor-intensive, a mathematical model is desired to study the effects of important parameters before the experiments are performed. Here, we describe a 3D mathematical model to predict the release of doxorubicin from pluronic gel to treat human breast cancer. This model can, ultimately, be used to effectively design the in vivo experiments.

Keywords—Breast Cancer, Doxorubicin, Controlled Release System, Diffusion and Convection Equation.

I. INTRODUCTION

CONTROLLED-release drug delivery [1], Doxorubicin (DOX), adriamycin, was used in this research. It is among the most widely used anticancer drug in chemotherapy treatment. And pluronic[®]F-127 (poloxamer 407, PF-127) is used to encapsulate the doxorubicin. It is block copolymer consisting of 70% of EO and 30% of PO in form of triblock copolymer, as shown in Fig. 1. PF-127 solution at a concentration of 20% or above exhibits thermoreversible gelation property. Therefore, it has a potential to formulate a thermoreversible gel for controlled delivery of drugs [2]. The drug mixed in the PF-127 gel is released from the polymer via polymer dissolution mechanism [2].

Manuscript received October 25, 2007. This work was supported in part by the the Department of Instrumentation and Control System Engineering, the Department of Chemical Engineering ,and the Department of Mechanical Engineering Faculty of Engineering at King Mongkut's University of Technology Thonburi, Bangkok, Thailand.

W. Kaowumpai ,Electrical Engineering Program, is with the Faculty of Engineering, King Mongkut's University of Technology Thonburi , Thailand (phone: (+66) 84-001-6626; e-mail: waseda_inc813@yahoo.com).

D. Koolpiruck is with Department of Electrical Engineering, Faculty of Engineering, King Mongkut's University of Technology Thonburi , Thailand (e-mail: diew.koo@kmutt.ac.th).

K. Viravaidya is with Department of Chemical Engineering, Faculty of Engineering, King Mongkut's University of Technology Thonburi , Thailand (e-mail: kwanchanok.vir@kmutt.ac.th).

From the previous study [3], a 2D model was develop to predict the release profile of doxorubicin from pluronic gel. The diffusion coefficient of doxorubicin inside pluronic gel is significantly low that the diffusion inside the gel is considered negligible.

As time proceeds, the gel's surface gradually decomposes and doxorubicin can be released into breast tissue at higher diffusion coefficient. This drug's diffusion looks similar to a soft threshold which is defined by sigmoid function.

The aim of this research is to develop a three dimensional simulation platform for Controlled-release drug delivery [4] of doxorubicin in breast model extended from the validated two dimensional controlled-release drug delivery model. In order to verify the two dimensional model previously developed, the prediction from the model was compared with the experimental result from the in vitro study.

In the in vitro setting, doxorubicin was initially incorporated into pluronic gel and allowed to be released into the surrounding Phosphate buffered saline (PBS) via the gel dissolution mechanism.

It is believed that a mathematical model will aid specialists to understand the drug delivery mechanism and allow physicians to make a decision on an optimal dose to treat patients.

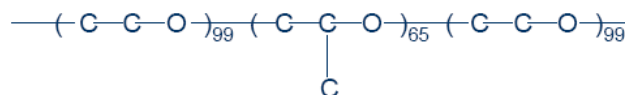

Fig. 1 The chemical structure of Pluronic[®]F-127

II. MATERIALS AND METHODS

The diffusion-convection equation was used to be assumption. Then natural threshold created by a sigmoid function will be used to account for drug's diffusion in a 2D drug delivery breast model. And this conception was applied to predict 3D drug delivery breast model on existent medical information. The overall methodology is shown in Fig. 2 as follows.

Fig. 3 shows the experimental set up used to validate the 2 dimension model. The image only captured the fluorescence of doxorubicin inside the pluronic gel which was located around the edge of the gel. The drug was allowed to diffuse for 3 mm in PBS solution.

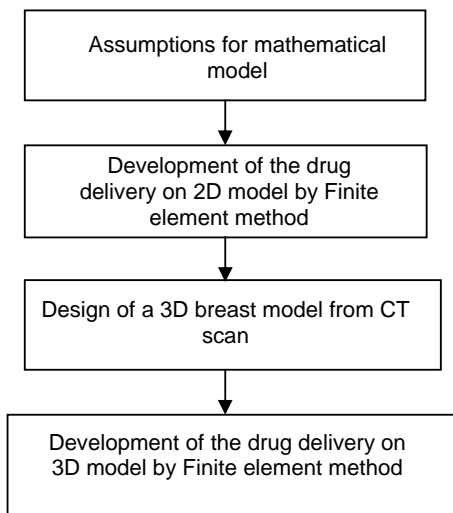

Fig. 2 Flowchart of method in our development

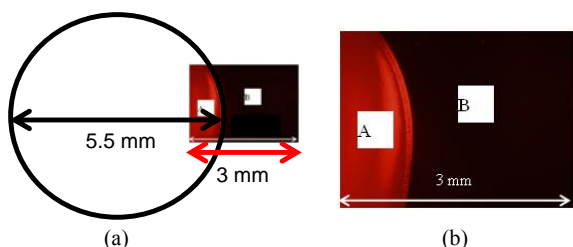

Fig. 3 Picture of doxorubicin was initially incorporated into pluronic gel and allowed to be released into the surrounding PBS solution. (a) Size of doxorubicin mixed with pluronic gel in PBS solution. (b) Magnified distance for measuring doxorubicin's concentration

A. Assumptions for Mathematical Model

Diffusion-convection equation (equation (1)) was applied to account for doxorubicin's release in a breast model. Once the model is verified, a more complex model will be developed as shown below:

$$\frac{\partial C_{dox}}{\partial t} + \vec{v} \Delta C_{dox} = \nabla \cdot (D \nabla C_{dox}) - k C_{dox} \quad (1)$$

- where C_{dox} is the concentration of drug (doxorubicin)
- t is time
- \vec{v} is fluid velocity vector
- D is diffusion coefficient of doxorubicin in PBS
- k is a drug consumption constant

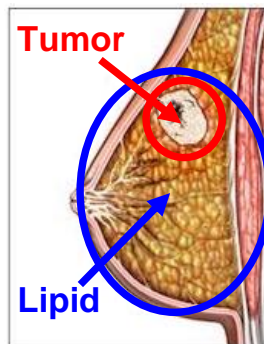

Fig. 4 Structure of breast with tumor

In Fig. 4, the most areas around the tumor are lipid. So the system has no fluid flow and temperature change is neglected. Hence, \vec{v} and k can be omitted as shown in the equation below.

Given that;

$$\vec{v} = 0 \quad (2)$$

$$k = 0 \quad (3)$$

Then we get;

$$\frac{\partial C_{dox}}{\partial t} = \nabla \cdot (D \nabla C_{dox}) \quad (4)$$

B. Development of the Drug Delivery on 2D Model by Finite Element Method

The diffusion rate in equation (4) was calculated using by finite element method. There were 1,552 triangular meshes generated for analysis and solved by UMFPACK Direct Solver.

Initial condition;

At initial time, Doxorubicin's concentration are determined to be 0.035 kg/m^3 within the drug's boundary as zone in Fig. 3 and 0 kg/m^3 outside the drug's boundary as zone B in Fig. 3.

$$C_{dox} = 0.035 \text{ kg/m}^3 ; 0 < r \leq R \text{ (zone A in Fig. 3.)} \quad (5)$$

$$C_{dox} = 0 \text{ kg/m}^3 ; r > R \text{ (zone B in Fig. 3.)} \quad (6)$$

where r is position of doxorubicin in the system
 R is radius of polymer (2.75 mm)

Boundary condition;

Logistic function[5] was attributed to be model of doxorubicin controlled release system. It will be applied to be function of r as below.

$$\text{Logistic function} = a \frac{1 + m e^{-r/\tau}}{1 + n e^{-r/\tau}} \quad (7)$$

Then we given that,

- $a = 1$
- $m = 0$
- $n = 15$
- $\tau = 5.5$

so we will get a sigmoid function[5],

$$\text{Sigmoid function} = \frac{1}{1+15e^{-r/5.5}} \quad (8)$$

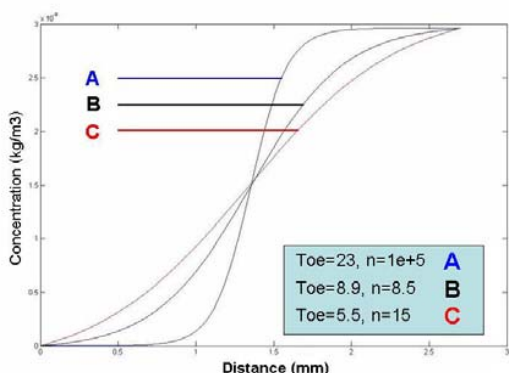

Fig. 5 Three sigmoid functions at difference of parameters

The mechanism of drug released from plironic gel mainly depends on gel dissolution kinetic. Therefore, the gel dissolution constant (K) [3] was added to model primarily control the drug releases from the polymer. The gel dissolution constants (K) were obtained from the experiments, shown in Fig. 6. Then 2.3 mm/hr gel dissolution constants was used to account for in the system.

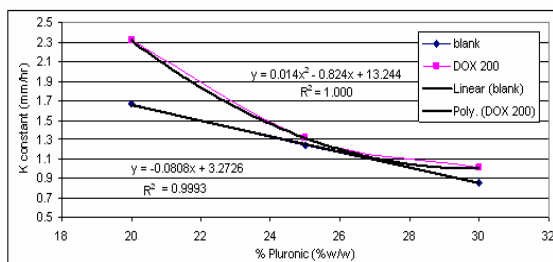

Fig. 6 Correlation between the percentage drug released and the percentage gel dissolved of Pluronic gel and 100 µg doxorubicin

In Fig. 7, The diffusion coefficient of doxorubicin inside the gel is significantly small which can be assumed to be zero and can be gradually increased to be higher value in PBS solution by sigmoid function. As time proceeds, gel's dissolving distance is $K \cdot t$ mm. Then the diffusion coefficient inside gel will be increased as the gel surface transforms from a solidified surface into a rubbery surface. The drug is released near the gel's erosive surface while the gel is dissolving. The drug concentration inside the gel seems to be moving in a sigmoid pattern towards the center of the polymer based on equation (9). And the released drug is freely diffused once outside the gel with the diffusion coefficient of D as in equation (10). The doxorubicin's diffusion coefficient in PBS solution is obtained from the literature.

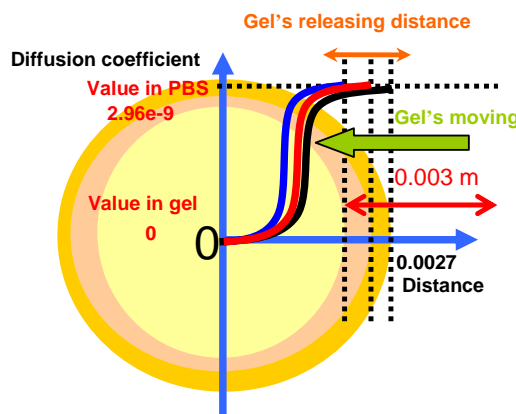

Fig. 7 Diffusion coefficient of doxorubicin by sigmoid function as time proceeding

$$D_{dox} = \text{Sigmoid function} ; 0 < r \leq (R - K \cdot t) \quad (9)$$

$$D_{dox} = D \text{ in PBS solution } (2.96 \times 10^{-5} \text{ cm}^2/\text{s}) [3] ; r > (R + K \cdot t) \quad (10)$$

Doxorubicin concentration as a function of time is shown in Fig. 8. And comparisons between the simulation results and the experimental results, the drug's concentration profile, reported for 3 mm. from the drug's rim to the outside in Fig. 3, at 855s and 1425s are also shown in Figs. 9-10, respectively.

So the drug control release system in PBS solution can be used to predict the experimental results in a 2D setting. And this assumption will also be assumed for 3D simulation.

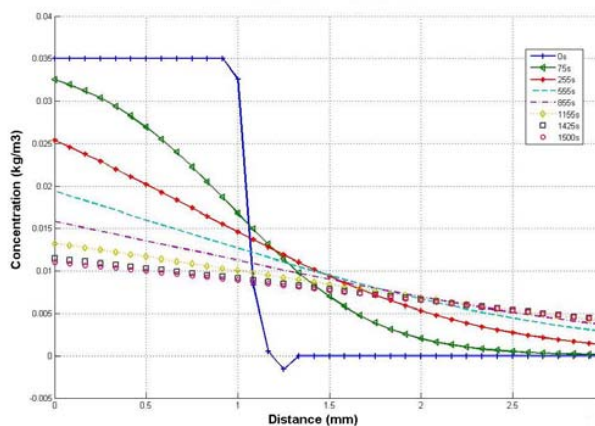

Fig. 8 Doxorubicin's concentration at 0s, 75s, 255s, 555s, 855s, 1155s, 1425s, and 1500s

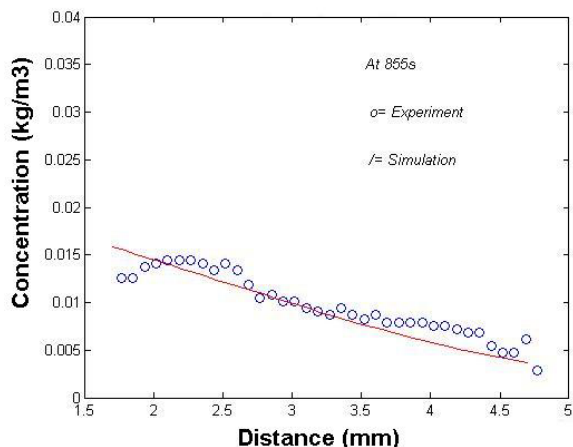

Fig. 9 Comparison of result between model and experiment at 855s

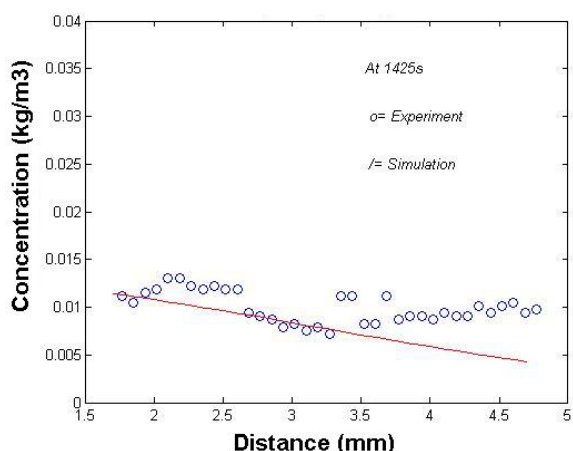

Fig. 10 Comparison of result between model and experiment at 1425s

C. Design of a 3D Breast Model from CT scan

The breast model was reconstructed from CT-scan image data [6] using a segmentation which is used to separate different materials within the object of interest. This is done based on the CT scan signal intensity of different tissues. For efficiently calculation in complex geometry, Small part of breast was chosen. This area is approximately 18 percents of tumor occurrence for women [7]. The shape of the tumor after resection was assumed to be sphere. Its diameter is approximately 2 cm [8]. To treat cancer, pluronic gel with the diameter of 2 cm was inserted to the space where tumor was recently removed, as shown in Fig. 11. This is considered the second stage breast cancer which survival rate for women receiving treatment is between 76 percents to 88 percents [9].

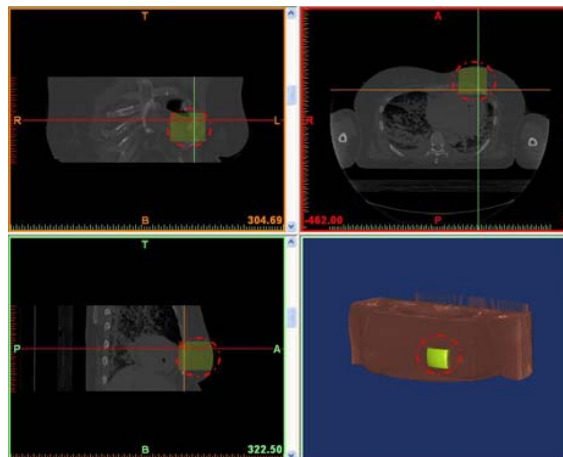

Fig. 11 Choose some part of breast model from CT-scan image

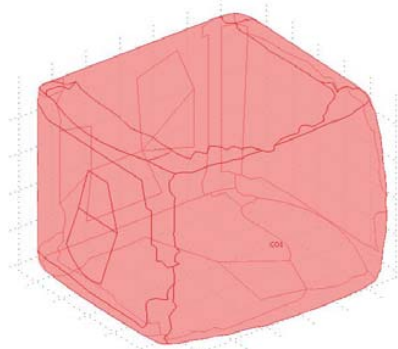

Fig. 12 Geometry of part of breast model

Mosteller equation [10] is used to find BSA (Body surface area) for dosage calculation. Because it is the most accurate and user-friendly and the CCI (the Cross Cancer Institute) adopt this equation as the standard formula on which all chemotherapy dosage should be based. This will alleviate many problems in clinical application and drug trials ultimately providing better care for patients.

Mosteller equation [10];

$$BSA(m^2) = \sqrt{\frac{Height(cm.) * Weight(kg.)}{3600}} \tag{11}$$

Patient's profile [10] are given that,

- Gender : Female
- Weight : 55 kg.
- Height : 165 cm.

So the BSA is 1.59 m². And treatment of doxorubicin requires a dose of 50mg/m² [11], [12]. The dosage can be calculated by equation (12)

$$\begin{aligned} \text{Calculated dosage} &= 1.59m^2 * 50mg / m^2 \\ &= 79.5mg \end{aligned} \tag{12}$$

In concentration calculation, the dosage will be divided by water's volume in human body. And the total body water of woman was calculated by Watson's formula of the total body water [13]. So this total body water are 29.1 L. Then the doxorubicin's dosage (concentration) is 2.73 mg/L or 5.02×10^{-3} M (mol/ m³). And this value was attributed to be initial doxorubicin's concentration and compared with EC50 (2.1×10^{-3} M) [14] in finite element method.

D. Development of the Drug Delivery on 3D Model by Finite Element Method

The diffusion rate in equation (4) was calculated using Finite Element Method. There were 39,257 tetrahedral generated for analysis. And this problem was solved by UMFPACK Direct Solver.

Initial condition;

$$C_{dox} = 5.02 \times 10^{-3} \text{ M}; 0 < r \leq R \quad (13)$$

$$C_{dox} = 0 \text{ M}; r > R \quad (14)$$

Boundary condition;

$$D_{dox} = \text{Sigmoid function}; 0 < r \leq (R - K \cdot t) \quad (15)$$

$$D_{dox} = D \text{ in normal breast tissue } (2.7 \times 10^{-10} \text{ cm}^2/\text{s}) [15] \\ ; r > (R + K \cdot t) \quad (16)$$

where r is position of doxorubicin in vivo system
 R is radius of polymer in vivo system (10 mm)

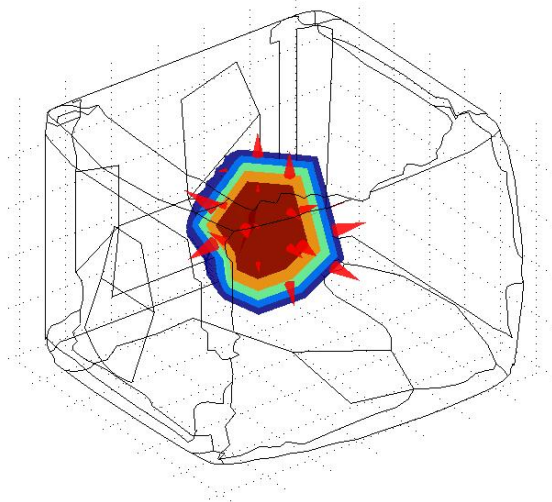

Fig. 13 The Doxorubicin's concentration and diffusive flux were shown by contours and arrows, respectively

III. RESULTS

From the results, Fig. 14, the drug's concentration profile, reported for 2 cm. from the drug's center to the outside, at 0s, 1 day, and 7 days are also shown in Fig. 15.

In Fig. 15, it's possible to show the efficiency of controlled release system. Because none outside gel's boundary (over 10 mm proximately) were EC50 or more.

Nonetheless, doxorubicin's diffusion coefficient in breast tissue (2.7×10^{-10} cm²/s) was rather low. Then, this still have some errors such as the doxorubicin's concentration at initial time should be 5.02×10^{-3} M. But the some of concentration's profile shows that more than 5.02×10^{-3} M of doxorubicin concentration is observed. The problems may come from the complication of a more realistic model. They caused to generating poor mesh and reducing effectiveness of the solver.

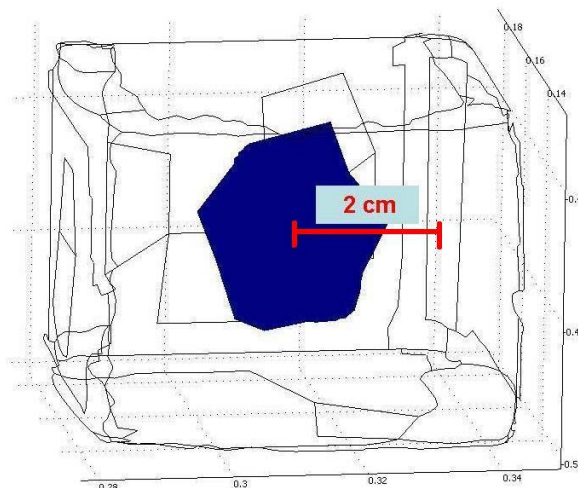

Fig. 14 Drug's concentration at difference of time

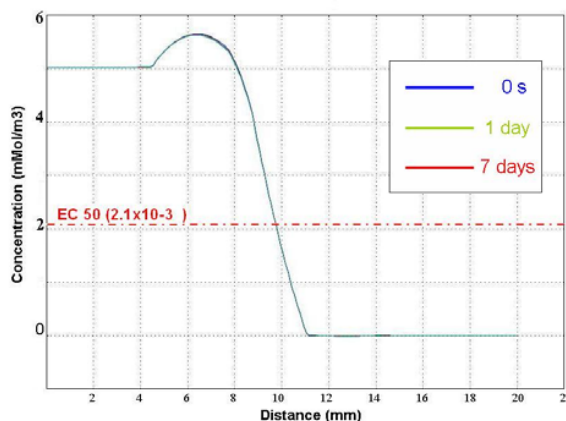

Fig. 15 Drug's concentration at difference of time

IV. DISCUSSION

Reconstruction of realistic geometry is more complicated than those of standard geometries. It gave more asymmetry of mesh elements which cause to limit of a number of meshes and selection of a solver. The simulation results still have some errors, even though they are converged.

However, the mesh refinement to improve the solution is in the progress.

V. CONCLUSION

A mathematical model is developed to predict the release kinetics and distribution profile of doxorubicin from Pluronic gel into the breast tissue. It will be useful to observe the side effect to adjacent tissue while concentration profile is releasing. This model accounts for the three dimensional distribution of the drug inside a physiologically realistic breast geometry.

Only diffusive condition is considered in this work. In the future work, we can modify this model to accommodate the convective condition as well as a more complex geometry. Mesh refinement and adaptive mesh will be used to improve for better accuracy.

REFERENCES

- [1] B. Reisfeld, S. Kalyanasundaram, and K. Leong "A mathematical model of polymeric controlled drug release and transport in the brain" *Journal of Controlled Release* vol.36, pp. 199-207, 1995.
- [2] Brannon-Peppas L 1997 *Polymers in Controlled Drug Delivery, Medical Plastics and Biomaterials Magazine*, [Online] Available at: <http://www.devicelink.com/mpb/archive/97/11/003.html>
- [3] W. Kaowumpai, D. Koolpiruck, and K. Viravaidya "Development of a mathematical model for Doxorubicin controlled release system using Pluronic gel for breast cancer" *Papers of Technical Meeting on Medical and Biological Engineering, IEE Japan* vol.06, no. 95-115, pp. 65-69, 2006.
- [4] S. Kalyanasundaram, V. D. Calhoun, K. W. Andleong, "A finite element model for predicting the distribution of drugs delivered in intracranially to the brain" *Am J Physiol Regul Integr Comp Physiol* vol. 273, pp. 1810-1821, 1997.
- [5] Wikipedia, the free encyclopedia. [Online] Available at: http://en.wikipedia.org/wiki/Logistic_function.
- [6] National Institutes of Health National Library of Medicine Bethesda, [Online] Available at: <http://vhnet.nlm.nih.gov/>
- [7] V. L. Andolina, et al. *Mammographic Imaging (A practical guide)*. J.B.Lipp. incott Co. Philadelphia. 1992.
- [8] American Joint Committee on Cancer.
- [9] D. Christopher, Abramson Cancer Center of the University of Pennsylvania.
- [10] D. S. Fischer, et al. *The Cancer Chemotherapy Handbook*. Mosby an Affiliate of Elsevier. 2003.
- [11] Steven B. Halls Professional Corporation, [Online] Available at: <http://www.halls.md/bsa/bsaVu5.htm>
- [12] C. F. Lacy, et al. *Drug Information Handbook International with Canadian and International Drug Monographs*. Lexi-Comp. 2005.
- [13] Charlie's Clinical Calculators, [Online] Available at: <http://www.fpnotebook.com/REN80.htm>
- [14] D. Caminada, C. Escher, and K. Fent, "Cytotoxicity of pharmaceuticals found in aquatic systems: Comparison of PLHC-1 and RTG-2 fish cell lines" *ScienceDirect - Aquatic Toxicology* vol. 79, pp. 114-123. 2006.
- [15] Jan Lankelma, Rafael Fernandez Luque, Henk Dekker, Wim Schinkel, and Herbert M. Pinedo. "A Mathematical Model of Drug Transport in Human Breast Cancer" *Microvascular Research* vol 59, pp. 149-161, 2000.