

An efficient passive planar micromixer with fin-shaped baffles in the tee channel for wide Reynolds number flow range

C. A. Cortes-Quiroz^{1,*}, A. Azarbadegan¹, E. Moeendarbary¹

Abstract— A new design of a planar passive T-micromixer with fin-shaped baffles in the mixing channel is presented. The mixing efficiency and the level of pressure loss in the channel have been investigated by numerical simulations in the range of Reynolds number (Re) 1 to 50. A Mixing index (Mi) has been defined to quantify the mixing efficiency, which results over 85% at both ends of the Re range, what demonstrates the micromixer can enhance mixing using the mechanisms of diffusion (lower Re) and convection (higher Re). Three geometric dimensions: radius of baffle, baffles pitch and height of the channel define the design parameters, and the mixing index and pressure loss are the performance parameters used to optimize the micromixer geometry with a multi-criteria optimization method. The Pareto front of designs with the optimum trade-offs, maximum mixing index with minimum pressure loss, is obtained. Experiments for qualitative and quantitative validation have been implemented.

Keywords—Computational Fluids Dynamics, Fin-shaped baffle, Mixing strategies, Multi-objective optimization, Passive micromixer

I. INTRODUCTION

IN recent years, microfluidics systems have been increasingly applied to perform functions such as separation, mixing, reaction, synthesis and analysis on a single chip called 'lab-on-a-chip' [1]. The development of this micro device concept and technology has found use in the sorting of cells, drug delivery, chemical and enzyme reactions, the synthesis of nucleic acids and the analysis of DNA and proteins [2]. An important performance factor for these microfluidics systems is the mixing efficiency which is critical in several applications, e.g. fast chemical reactions, biochemical analysis.

In a microscopic domain the Reynolds number is low and flow is restricted to the laminar regime. In these flows, molecular diffusion is a very slow mixing mechanism that increases the length of micro-channels and the time required for complete mixing. Micromixers are components of lab-on-a-chip and bio-MEMS systems that have been developed to achieve fast mixing. Their design is based on promoting three processes of fluids mixing: molecular diffusion, stretching and folding and breakup [3]. Several micromixers designs have been reported in the literature and they can be classified into

active and passive micromixers [4, 5]. Active mixers induce turbulent flows either by using moving parts or an external power source such as an electric field, magnetic field, acoustics, pressure, hydrodynamics, etc. Passive mixers do not have an extra forcing mechanism and mixing is achieved by creating a transverse flow through modification of their geometries.

Passive micromixers have been preferred in most applications due to their simple design, easiness of fabrication and integration. The passive designs are commonly based on the mixing mechanisms of chaotic advection and lamination. The chaotic micromixers enhance mixing with 3D channel structures [6, 7, 8] or geometrical planar shapes [9, 10, 11]. The planar designs are easier to fabricate and to integrate with microsystems but they need to be operated at $Re > 100$ that results in very high pressure loss (200 KPa) [10] or need long channels over 10 mm [11] when working at $Re < 1$ to achieve high mixing performance. The lamination micromixers are based on molecular diffusion mechanism [12, 13] and they can achieve high mixing at lower Re but their fabrication is complex.

Most of the micromixers are based on a single mixing mechanism i.e. chaotic advection or molecular diffusion, what limits their range of operability (Reynolds number) and, therefore, their application in different microfluidics systems.

In this paper, a novel planar passive micromixer is proposed. A set of baffles with a shape that resembles the fin of a fish defines the shape of the microchannel for an improved mixing. The mixing efficiency and pressure loss have been investigated by numerical simulations for different values of selected geometric parameters over a wide range of Reynolds number ($1 \leq Re \leq 50$). These variables have been used as performance and design parameters to apply the method presented by Cortes-Quiroz *et al* [14] to optimize micromixers performance with multi-objective criteria. The resulting optimum design gives the highest mixing index with the lowest pressure drop in the channel. The proposed micromixer design is suitable for μ TAS applications due to its passive nature, the high mixing quality with low pressure drop possible to achieve in short lengths, the continuous flow that make it free of dead volumes or large recirculation zones with lower possibility of clogging, characteristics that ensure consistent effectiveness in biochemical processes.

* Corresponding author: Tel.: ++44 (0)2076 793997; Fax: ++44 (0)2073 880180; Email: cesar.cortes@ucl.ac.uk

1: Department of Mechanical Engineering, University College London, UK

II. MICROMIXER DESIGN

Fig. 1 shows the schematic diagram of the micromixer with fin-shaped baffles in the mixing channel. To the basic tee micromixer with two inlet channels and one central channel, series of baffles have been included in the central channel to enhance mixing by inducing lateral convection as well as reducing locally the diffusion path. Each mixing unit has two baffle obstacles, each one on opposite walls of the channel. When the fluids flow approaches the gap between one obstacle and the opposite wall, the direction of the fluid occupying the same side of the baffle in the channel becomes transversal to the main bulk flow which is accelerated due to reduction of the cross section area. After that, the flow decelerates in between two obstacles to accelerate again when passing through the next gap. The obstacles enhance mixing by the effects of focusing and diverging of the flow.

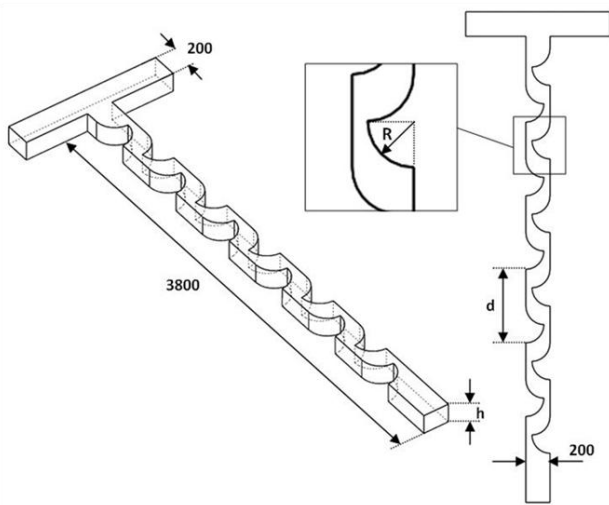

Fig. 1 Schematic diagram of the passive micromixer with fin-shaped baffles in the mixing channel

In fig. 1, symbol R represents the radius of the quarter of circle that defines the shape of a baffle, d is the pitch of the baffles structures and h the height of the channels; these variables are used later to define the optimum design. The lengths of inlet and outlet channels are fixed at 400 and 3800 μm , respectively; these values were chosen to ensure that fully developed flows are formed at inlet channels before reaching the T-junction and that the distance between the last obstacle and the outlet section is minimum 200 μm . The width of the channels is 200 μm and the distance between side inlet channel wall and the first obstacle is equal to 50 μm .

III. NUMERICAL SIMULATION

The transport process in the micromixer is studied by using a Computational Fluids Dynamics (CFD) code, CFX-11 [15], which is based on the Finite Volume Method. The different models of the micromixer used in this study were built and meshed by using the ANSYS Workbench components Design

Modeller and CFX-Mesh.

The flow is defined viscous, isothermal, incompressible, laminar and in steady-state. The CFD code solves numerically the equations that govern the flow field within the devices: continuity equation (1), momentum equation (2) and species convection-diffusion equation (3).

$$\nabla V = 0 \quad (1)$$

$$\rho V \nabla V = -\nabla P + \mu \nabla^2 V \quad (2)$$

$$V \nabla c = D \nabla^2 c \quad (3)$$

where ρ and μ are the density and viscosity of the fluid respectively, V and P are the velocity and pressure vectors respectively, c is the mass fraction or concentration of the fluid under analysis and D is the diffusion coefficient of the fluid in the other fluid. Advection terms in each equation are discretised with a second order differencing scheme which minimize numerical diffusion in the results. The simulations were defined to reach convergence when the normalized residual for the mass fraction fell below 1×10^{-5} .

The boundary condition for the velocity at the inlets is mass inflow to have a uniform velocity profile in the direction of the bulk flow whereas the other components are zero. The velocity values at the inlets are equal and give a laminar flow regime with Reynolds numbers approximately equal to 1, 5 and 20 in the mixing channel. Along the walls, non-slip boundary condition is used for the tangential velocity component whereas the normal component is zero. At the outlet end of the mixing channel, a constant pressure condition (gauge pressure $P = 0$) is specified. Water at 25 °C and a solution of Fluorescein in Water are the fluids used in the study, the boundary conditions for the species balance are mass fractions equal to 0 at the inlet where pure water is fed and equal to 1 at the inlet where the solution is fed.

A variable mesh composed of tetrahedral elements inside the volume and prism elements adjacent to the walls is used and arranged to provide sufficient resolution for boundary layers near the fluid-solid interfaces. In order to obtain mesh-independent results from the simulations, a preliminary mesh size sensitivity study was carried out to determine the interval size of convergence.

In order to measure and compare the mixing intensity using the outputs from CFD code, a Mixing index, Mi , is defined based on the intensity of segregation introduced by Danckwerts [16] and calculated with equation 4:

$$Mi = 1 - \sqrt{\frac{\int_A (c - \bar{c})^2 dA}{A \cdot \bar{c} (1 - \bar{c})}} \quad (4)$$

where c is the concentration distribution at the selected cross-section plane (in this study, it is the outlet plane at the end of the mixing channel), \bar{c} is the averaged value of the concentration field on the plane and A is the area of the plane.

M_i reaches a value of 0 for a complete segregated system and a value of 1 for the homogeneously mixed case. The mass concentration information from CFD analyses is used in equation 4.

IV. MICROMIXER PERFORMANCE ANALYSIS AND OPTIMIZATION PROCEDURE

The CFD simulations described above have been integrated in an analysis and optimization method presented by Cortes-Quiroz *et al* [14] to define a CFD based Optimization study of the proposed fin-shaped baffles micromixer. The schematic diagram of the method is shown in fig. 2; the optimization is based on the use of the following techniques: Design of Experiments (DOE), Surrogate modeling (SM) and Multi-Objective Genetic Algorithm (MOGA) to optimize the geometry of the micromixer (design parameters) for a set of performance parameters under different operational conditions, i.e. Reynolds numbers (Re).

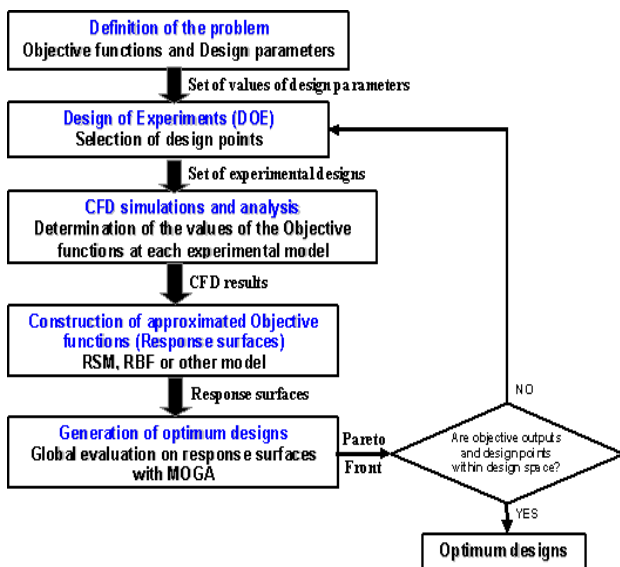

Fig. 2 Flowchart of the methodology process (modified from [14])

The process starts with the selection of design parameters and their range of variation as well as the performance parameters to be evaluated. With the design parameters, the DOE method is used to create the experimental table which corresponds to different geometries that represent the design space. The flow transport process in these geometries is solved then by CFD to compute the performance parameters. Once the flow field is solved and the performance parameters calculated, the SM technique can be used to define the approximated objective functions or response surfaces that relate the performance parameters to design parameters. The accuracy of the response surface is a critical step in the design process since the Multi-objective Genetic Algorithm (MOGA) is run on it. The response surface enables to evaluate the objective functions of the performance parameters without carrying out expensive CFD analysis for each configuration.

The Pareto front of designs with the optimum trade-offs of the design objectives (performance parameters) in a specific design space is finally obtained.

A. Selection of performance and design parameters

The mixing index (M_i) and the pressure loss (ΔP) in the mixing channel are the performance parameters defined in this study. The M_i is evaluated by equation 4 and the ΔP by the difference between the area weighted average of total pressure on the outlet plane and on a cross section plane at the inlet of the mixing channel.

Fig. 1 displays the geometric dimensions in the micromixer that can be used for the design parameterization. The design parameters of the micromixer have been defined as follows: Radius of baffle (R), Pitch of baffles (d), and height of the channel (h). The following geometric features are fixed: width of the mixing channel, 200 μm ; width of inlet channels, 200 μm and length of mixing channel, 3800 μm . The baffles in the designs are placed only in the first 3600 μm of the mixing channel to avoid any distortion on the measurement of mixing at the outlet section.

B. Design of experiments (DOE)

DOE technique defines a subset of design points (experiments) from the design space which is representative enough to evaluate the influence of designs parameters on performance parameters.

In this study, the Taguchi method [17] is used. It defines an Orthogonal Array (OA) that gives much reduced variance for the experiments with optimum settings of design parameters. Table I shows the levels of the design parameters in the experiments (designs points). The 18 experiments (CFD simulations) are defined in the reduced Taguchi's OA L_{18} shown in table II.

TABLE I
DESIGNS PARAMETERS AND LEVELS

Level	Parameter	h	$r = R/25$	$Q = d/R$
1		100	4	4
2		125	5	5
3		150	6	6

C. Surrogate model. Response surfaces construction

The values of design parameters X_i of the micromixer designs defined in the DOE matrix (table II) and the performance parameters P_j (mixing index, pressure drop) values that result from CFD calculations are correlated by approximated functions:

$$P_j = p_j(X_i), \quad i=1 \text{ to } N, \quad j=1 \text{ to } M \quad (5)$$

where N is the number of design parameters and M is the number of performance parameters. The Radial Basis Function, RBF [18], has been used to build the approximation

of the correlating functions p_j .

TABLE II
ORTHOGONAL ARRAY L_{18} (DESIGN MATRIX)

Experiment ^b	Parameter ^a	h	$r = R/25$	$Q = d/R$
1		1	1	1
2		1	2	2
3		1	3	3
4		2	1	1
5		2	2	2
6		2	3	3
7		3	1	2
8		3	2	3
9		3	3	1
10		1	1	3
11		1	2	1
12		1	3	2
13		2	1	2
14		2	2	3
15		2	3	1
16		3	1	3
17		3	2	1
18		3	3	2

^a The values in the columns of factors correspond to the levels in table I.

^b Experiments correspond to the designs used for CFD analysis.

The RBF is a two-layered neural network with a hidden layer of radial units and an output layer of linear units. The hidden layer consists of a set of radial basis functions that act as activation functions which have different responses depending on the distance between the input and the centre. The RBF is fairly compact, where the linear nature of the radial basis functions reduces computational cost to have a reasonably fast training. The model for the function is a linear combination of a set of weighted basis functions; the prediction capacity of the network is stored in the weights which can be obtained from a set of training patterns. This process is equivalent to finding a surface in multidimensional space that provides the best fit to the training data, which is then used to interpolate the test data.

D. Searching of optimum designs

Numerical optimization methods constitute an efficient tool for analyzing the correlations between geometrical parameters

and device performance from CFD calculations and for finding their optimum combination. Since micromixing optimization is a non linear problem, an exploratory technique has to be used for seeking the global optimum; it evaluates designs throughout the parameter space and only uses the objective functions values that have been computed. In this study, a genetic algorithm has been used due to its capacity to be implemented to solve multi-objective optimization problems. This multi-objective genetic algorithm (MOGA) can converge to a population composed of individuals that belong to the Pareto front of the solutions. To avoid the high number of evaluations of the objective function that are required to reach an optimum configuration, the actual objective functions are replaced by the approximated functions (response surfaces) built as described in section C.

The Non-dominated Sorting Genetic Algorithm (NSGA-II) [19] has been applied on the response surfaces with the following parameters values: Population size = 32, Number of generations = 100, Crossover probability = 0.9, Crossover distribution index = 20 and Mutation distribution index = 100. The application pursued the maximization of the mixing index and the minimization of the pressure loss.

V. RESULTS AND ANALYSIS

The Mixing index outcomes from CFD at the outlet section of the mixing channel are shown in fig. 3; one can observe that the relative difference in mixing performance among the 18 designs is preserved at different Reynolds number. Between $Re = 1$ and $Re = 20$ the effect of diffusion is significant which is helped by the flow path width reduction and expansion due to the presence of the baffles. At $Re = 50$, the effect of convection mixing is more important and it results on peak values of mixing index that are comparable to the values at $Re = 1$. This variation of the mixing performance reveals that it is possible to achieve high mixing performance at low Re and high Re flows in the micromixer with fin-shaped baffles in the channel.

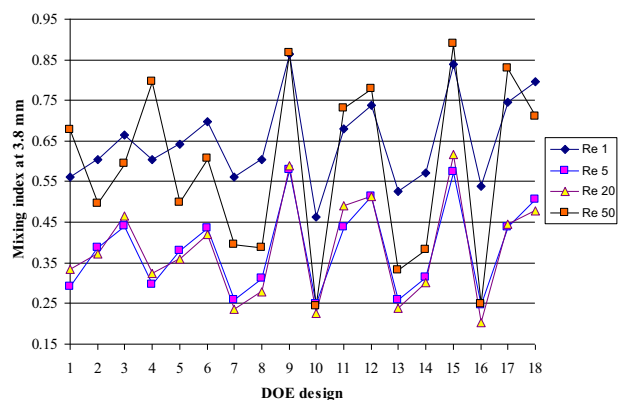

Fig. 3 Mixing index at the outlet section of designs of OA L_{18}

Fig. 4 shows the pressure loss in the mixing channel of the 18 DOE designs at different Reynolds numbers. The Y-axis is in

log scale to show more clearly that the relative difference of the pressure loss among the designs is independent of the Reynolds number but the absolute values at each design increase with the Reynolds number i.e. with the volume flow rate.

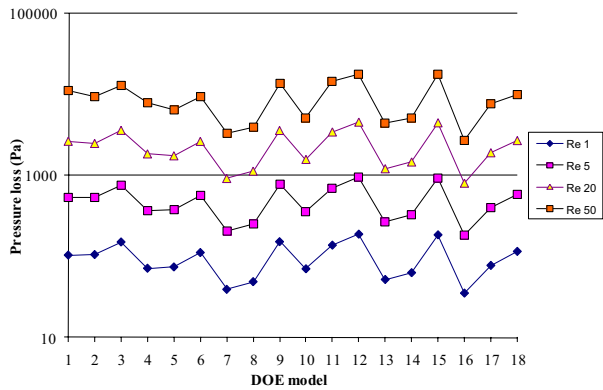

Fig. 4 Pressure loss in the mixing channel of designs of OA L₁₈

From figures 3 and 4, one can conclude that the channel geometry defined by the baffles and the depth of the channel has a direct effect on the mixing index and pressure loss that their values can be predicted from the values obtained in some few designs.

To find designs with high mixing performance and minimum possible pressure loss, geometric features can be explored by applying the procedure described in section IV.C and IV.D.

The response surfaces for both performance parameters, mixing index and pressure drop, are built using the RBF method on the 18 designs of OA L₁₈. The values of the design parameters and the corresponding objective functions (performance parameters outcomes from CFD analysis) are used to train the network.

After building the response functions, the NSGA-II is applied on them. The results for Re = 1 are shown in fig. 5; the application gives an in-bounded set of optimum designs, i.e. the ranges of the two performance parameters are in the positive zone with coherent values (0 to 1 for mixing index and > 0 for pressure drop), for the entire population generated by the genetic algorithm. These results confirm that the ranges and levels of the design parameters in table 1 were selected properly for their use in table 2. The Pareto front (Pf) of the designs that give the optimum trade-off of mixing index and pressure drop is clearly depicted in fig. 5.

To validate the numerical optimization, some design points on the Pf are chosen to prepare the corresponding models for CFD analysis. In fig. 6, the CFD outcomes are compared to the values predicted by the optimization method. The average differences in percentage between these results are about 3% in mixing index and 1% in pressure drop what shows that the optimization technique gives the trend of mixing performance vs. pressure drop of the optimum designs of the Pf with

reasonably accuracy.

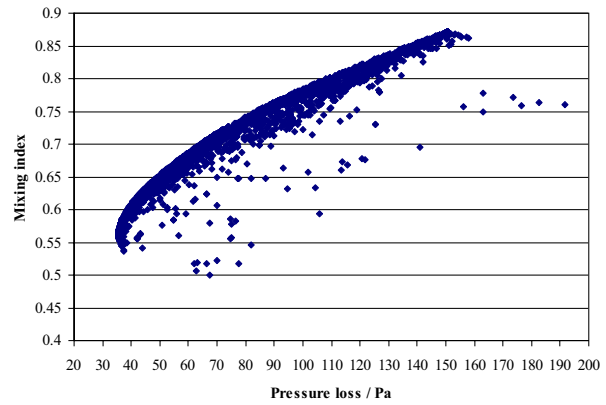

Fig. 5 Results from the application of NSGA-II on RBF approx. functions built from CFD results on 18 designs at Re = 1

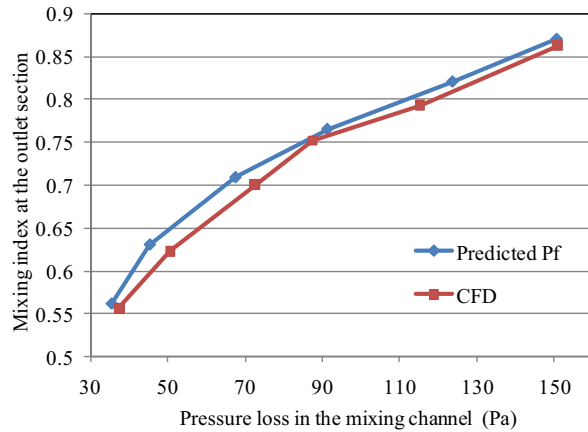

Fig. 6 Mixing index vs. pressure loss in selected designs of the Pareto front, Re = 1

The values of the design parameters of the six selected designs of the Pareto front are shown in table III. From this table, the height of the channel is equal to 150 μm in all the designs, what is the maximum value in its range (see table I), since bigger cross section of the channel reduces the pressure loss for the same Reynolds number flow. Along the Pareto front, the designs show an increment in both, pressure loss and mixing index, what in table III corresponds to the increment in parameter r and the reduction of parameter Q . Since these parameters are function of the radius of the baffles, R , the optimization method finds the values that fulfil the goal of maximizing the mixing index whereas the pressure loss is the minimum possible to achieve. In general, bigger baffles with short distance between them (short pitch) seem to satisfy the optimization goal, but it is the method applied that predicts the values of the design parameters of the optimum designs which do not cover necessarily the whole range given in table I.

The contour of the mass concentration of fluorescein solution on a horizontal plane at half the height of the optimum micromixer (Pf-6 in table III) is shown in fig. 7 for a flow with

$Re = 1$. A mixing performance above 0.85 is achievable in a mixing channel length of 3.8 mm.

TABLE III
DESIGN PARAMETERS OF PARETO FRONT DESIGNS, $Re = 1$

Pf design	Parameters		
	$H (\mu m)$	$r = R/25$	$Q = d/R$
Pf-1	150	4.34	5.78
Pf-2	150	4.40	4.59
Pf-3	150	4.83	4.12
Pf-4	150	5.27	4.07
Pf-5	150	5.80	4.24
Pf-6	150	6.00	4.00

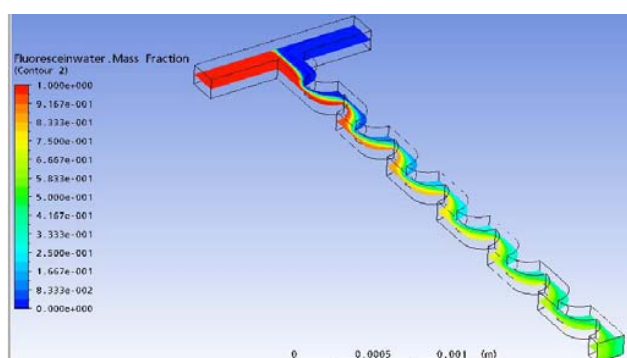

Fig. 7 Fluorescein mass fraction on plane at half the height of design Pf-6 (table III) for $Re = 1$ in the mixing channel

VI. EXPERIMENTAL WORK

For the optimum designs, experimental tests have been implemented to validate the numerical results qualitatively and quantitatively. The quantitative analysis use fluorescent dyes to evaluate mixing and will be presented in the conference.

VII. CONCLUSION

The study proposed a novel planar passive micromixer which includes a set of fin-shaped baffles in the main channel of a tee micromixer to enhance mixing. The dimensions and distribution of the baffles in the channel as well as the depth of the channel have been used as design parameters in a multi-criteria optimization method to find the optimum designs that give the trade-off of highest mixing quality with lowest pressure loss. It has been found the selected geometric parameters affect mixing and pressure loss in similar form independently of the flow rate (Reynolds number) so one optimum design can be suitable for different operation conditions. The level of mixing can be above 85% for Re in the order of 1 and in the order of 50 for a channel length of 3.8 mm, what implies the micromixer used two mixing mechanisms: molecular diffusion (low Re flow) and convective agitation (high Re flow) with comparable efficiency. The shape of the baffles reduces the possibility of

clogging and minimizes the dead volumes; they also increase drastically the ratio surface/volume what may be used for applications that involve heat transfer or catalytic reactions. The planar design with simple geometry of the micromixer makes its fabrication an easy task and, because of its adaptability to work with high and low flow rates giving high mixing performance, it is potentially applicable in lab-on-a-chip and chemical microreaction systems.

ACKNOWLEDGMENT

We gratefully acknowledge the Dorothy Hodgkin Postgraduate Award (DHPA) of the Engineering and Physical Sciences Research Council (EPSRC) of United Kingdom.

REFERENCES

- [1] Stone H. A., Stroock A. D. and Ajdari A. (2004). Engineering flows in small devices: microfluidics toward a lab-on-a-chip. *Annu. Rev. Fluid Mech.* 36: 381-411.
- [2] Hansen C. and Quake S. R. (2003). Microfluidics in structural biology: smaller, faster, better. *Curr. Opin. Struc. Biol.* 13: 538-544.
- [3] Ottino J. M., 1989. The kinematics of mixing: stretching, chaos and transport. Cambridge University Press. Cambridge.
- [4] Nguyen N. and Wu Z. (2005). Micromixers-a review. *Journal of Micromechanics and Microengineering* 15, R1-R16.
- [5] Hessel V., Lowe H. and Schonfeld F. (2005). Micromixers, a review on passive and active mixing principles. *Chem. Eng. Sci.* 60, 2479-2501.
- [6] Liu R. H., Stremler M. A., Sharp K. V., Olsen M. G., Santiago J. G., Adrian R. J., Aref H. and Beebe D. J. (2000). Passive Mixing in a Three-Dimensional Serpentine Microchannel. *Journal of Microelectromechanical Systems* 9 (2), 190-197.
- [7] Jen C. P., Wu C. Y., Lin Y. C. and Wu C. Y. (2003). Design and simulation of the gaseous micromixer with chaotic advection in twisted microchannels. *Lab on a Chip* 3: 77-81.
- [8] Kim D. S., Lee S. W., Kwon T. H. and Lee S. S. (2004). A barrier embedded chaotic micromixer. *J. Micromech. Microeng.* 14: 798-805.
- [9] Hong C. C., Choi J. W. and Ahn C. H. (2001). A novel in-plane passive micromixer using Coanda effect. *Proceedings of the μ TAS 2001 Symposium, California, USA, pp. 31-33.*
- [10] Wong S. H., Bryant P., Ward M. and Wharton C. (2003). Investigation of mixing in a cross-shaped micromixer with static mixing elements for reaction kinetics studies. *Sens. Actuators B* 95: 414-424.
- [11] Bhagat A. A. S., Peterson E. T. K. and Papautsky I. (2007). A passive planar micromixer with obstructions for mixing at low Reynolds numbers. *J. Micromech. Microeng.* 17: 1017-1024.
- [12] Wu Z. and Nguyen N. Y. (2005). Convective-diffusive transport in parallel lamination micromixers. *Microfluid. Nanofluid.* 1: 208-217.
- [13] Ducree J., Brenner T., Haeberle S., Glatzel T. and Zengerle R. (2006). Multilamination of flows in planar networks of rotating microchannels. *Microfluid. Nanofluid.* 2: 78-84.
- [14] Cortes-Quiroz C. A., Zangeneh M. and Goto A. (2009). On multi-objective optimization of geometry of staggered herringbone micromixer. *Microfluid. Nanofluid.* 7 (1), 29-43.
- [15] ANSYS Europe Ltd., 2007. CFX 11.0 User Manual.
- [16] Danckwerts P. V. (1952). The definition and measurement of some characteristics of mixtures. *Appl. Sci. Res.* A 3, 279-296.
- [17] Taguchi G. (1987). *Systems of Experimental Design, Vols. 1 and 2.* New York: Kraus International.
- [18] Kansa E. J. (1999). Motivation for using radial basis function to solve PDE's (unpublished paper), in <http://rbf-pde.uah.edu/kansaweb.html>, accessed on Aug 22nd, 2007.
- [19] Deb K., Agrawal A., Pratap T. and Meyarivan T. (2000). A fast and elitist multi-objective genetic algorithm for multi-objective optimization: NSGA-II. *Proceedings of the Parallel Problem Solving from Nature VI Conference*, pp. 849-858, Paris, France, 2000.