

An Innovative Transient Free Adaptive SVC in Stepless Mode of Control

U. Gudar and D. R. Patil

Abstract—Electrical distribution systems are incurring large losses as the loads are wide spread, inadequate reactive power compensation facilities and their improper control. A comprehensive static VAR compensator consisting of capacitor bank in five binary sequential steps in conjunction with a thyristor controlled reactor of smallest step size is employed in the investigative work. The work deals with the performance evaluation through analytical studies and practical implementation on an existing system. A fast acting error adaptive controller is developed suitable both for contactor and thyristor switched capacitors. The switching operations achieved are transient free, practically no need to provide inrush current limiting reactors, TCR size minimum providing small percentages of nontriplen harmonics, facilitates stepless variation of reactive power depending on load requirement so as maintain power factor near unity always. It is elegant, closed loop microcontroller system having the features of self regulation in adaptive mode for automatic adjustment. It is successfully tested on a distribution transformer of three phase 50 Hz, Dy11, 11KV/440V, 125 KVA capacity and the functional feasibility and technical soundness are established. The controller developed is new, adaptable to both LT & HT systems and practically established to be giving reliable performance.

Keywords—Binary Sequential switched capacitor bank, TCR, Nontriplen harmonics, step less Q control, transient free

I. INTRODUCTION

IT is well documented in literature and through public discussions at various levels that a substantial power loss is taking place in our low voltage distribution systems on account of poor power factor, due to inadequate reactive power compensation facilities and their improper control. Switched LT capacitors can directly supply the reactive power of loads and improve the operating condition. Government of India has been insisting on shunt capacitor installations in massive way and encouraging the state electricity boards through Rural Electrification Corporation and various other financing bodies [1, 2]. The expansion of rural power distribution systems with new connections and catering to agricultural sector in wide spread remote areas, giving rise to more inductive loads resulting in very low power factors. The voltages at the remote ends are low and the farmer's use high HP motors operating at low load levels with low efficiencies. This is giving rise to large losses in the distribution network.

U. Gudar Member, IEEE, Department of Electrical Engineering, Walchand College of Engineering, Sangli, Maharashtra, INDIA, PIN-416415 ugudar@gmail.com

D.R.Patil Department of Electrical engineering, Walchand College of Engineering, Sangli, Maharashtra, INDIA, PIN-416415dadasorpatil@gmail.com

Thus there exists a great necessity to closely match reactive power with the load so as to improve power factor, boost the voltage and reduce the losses. The conventional methods of reactive power supply are through switched LT capacitors, mostly in equal steps in various automatic power factor controllers developed by number of companies. In this paper, a more reliable, technically sound, fast acting and low cost scheme is presented by arranging the contactor switched capacitor units in five binary sequential steps. This enables the reactive power variation with the least possible resolution. In addition a thyristor controlled reactor of the lowest step size is operated in conjunction with capacitor bank, so as to achieve continuously variable reactive power. As there is reduction in loss with shunt compensation in the feeders, the efficiency increases and conservation of energy takes place. Besides the enhancement transformer loading capability the shunt capacitor also improves the feeder performance, reduces voltage drop in the feeder & transformer, better voltage at load end, improves power factor, improves system security with enhanced utilization of transformer capacity, gives scope for additional loading, increases over all efficiency, saves energy due to reduced system losses, avoids low power factor penalty, and reduces maximum demand charges.

A. SVC With Binary Sequential Switched Capacitors

The SVC is indispensable and based on proven technology for power factor correction and reactive power compensation. Traditionally SVC has been used as a shunt device that offers voltage stability and reactive power compensation to the load or at PCC. Since EPRI's (Electric Power Research Institute) release of FACTS strategies in 1987 SVC's have grown in popularity and are well established in power industry [3].

The Basin Electric Power Corporation installed the first SVC in Nebraska in 1977 [4, 5]. The simplest configuration for an advanced shunt compensator essentially consists of the thyristor switched capacitor bank with each capacitor step connected to the system through a thyristor switch. In the proposed paper capacitor bank step values are chosen in binary sequence weights to make the resolution small. If such 'n' capacitor steps are used then 2^n different compensation levels can be provided due to those many possibilities. It is important to ensure that static compensator steps are switched at appropriate times so that transients are minimized / not allowed to occur. For both capacitors and inductor, the appropriate switching instants occur at the zero crossing of both current and voltage waves. In the standard configuration of TSC, a damping reactor is included to limit the di/dt on

switching and to damp the switching transients that follow. An analysis of switching transients indicates that transient free switching can occur if the following two conditions are met [6, 7].

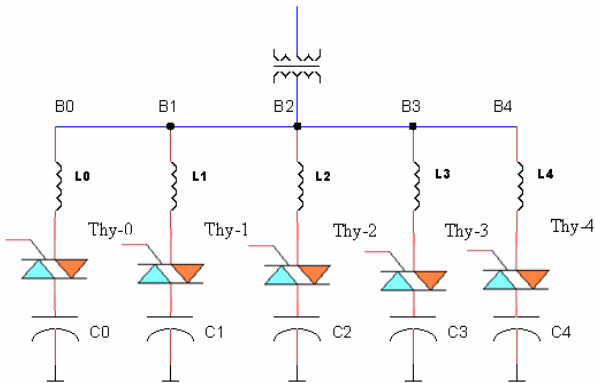

Fig.1 TSC with arrangement in binary sequential mode

- a) The thyristor is fired at the negative/positive peak of voltage, and/or
- b) Capacitor is precharged to the negative/positive peak voltage.

The first condition can be met accurately by timing the control circuitry and the second condition is only met immediately after switching off thyristor. The configuration for five capacitor bank steps in binary sequence weight with thyristors switch and inrush current limiting reactor is shown in fig. 1

B. FC-TCR Scheme

The Fig. 2 shows the basic configuration of static compensator FC-TCR. In this case capacitor represents a switched capacitor bank either as mechanically switched or thyristor switched in binary sequential steps as explained earlier and **L** represents reactor with phase angle control [8, 9, 10].

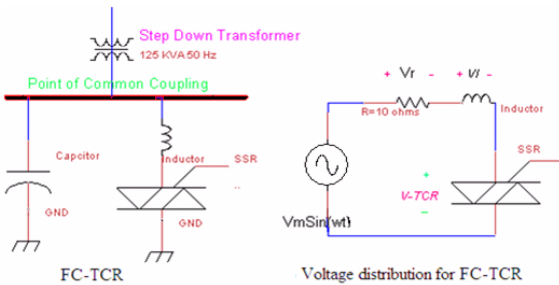

Fig. 2 FC-TCR Scheme

Fig. 2 FC-TCR Scheme

The controllable range of TCR firing angle α extends from 90° to 180° . In case of ideal reactor of **L** Henry firing angle of 90° results in full conduction with continuous sinusoidal current flow. Practically all six air cored reactors are designed with an average resistance of 10Ω and inductance of 230 mH.

The following “(1)” [6] illustrates the relation between firing angle α and the current through inductor I_L for ideal inductor having resistance tending towards zero while “(2)”

represents the practical case considering resistance $R \Omega$.

$$I_L = \left(\frac{V}{\omega L} \right) \left(1 - \left(\frac{2}{\pi} \right) \alpha - \left(\frac{1}{\pi} \right) \sin 2\alpha \right) \dots (1)$$

$$I_L(\alpha) = \frac{V_m}{\sqrt{R^2 + X_L^2}} \left[\frac{1}{2\pi} \left\{ (\beta - \alpha) + \frac{\sin 2\alpha}{2} - \frac{\sin 2\beta}{2} \right\} \right]^{0.5} \dots (2)$$

The following observations are important.

- i) If $\alpha = \theta$ i. e. firing angle = phase angle
 $\sin(\beta - \theta) = \sin(\beta - \alpha) = 0$
 and conduction angle = $\beta - \alpha = \pi$
- ii) Conduction angle should not exceed π
 The range of control angle α is $\theta \leq \alpha \leq \pi$

$$I_1 \alpha = \frac{V_L}{Z} = V_m Y_{TCR(\alpha-\theta)} \dots (3)$$

Where

$$Y_{TCR(\alpha-\theta)} = Y_{Max} \left[\frac{1}{2\pi} \left\{ (\beta - \alpha) + \frac{\sin 2\alpha}{2} - \frac{\sin 2\beta}{2} \right\} \right]^{0.5} (4)$$

Thus the TCR acts like a variable admittance. By varying the firing angle α admittance changes and consequently fundamental current component which in turn gives rise to variation of reactive power absorbed by reactor. Hence if $\alpha = \theta = 85.5^\circ$ continuous conduction of current take place. However, if firing angle is increased beyond this, non-sinusoidal currents are generated and hence harmonics get introduced. The rms value of n^{th} order harmonic is expressed as a function of α in the following equation.

$$I_n(\alpha) = \frac{V}{Z} \times \frac{2}{\pi} \left[\frac{-2 \cos(\alpha - \theta)}{n} \sin n(\alpha - \theta) + \frac{\sin(n-1)(\alpha - \theta)}{n-1} + \frac{\sin(n+1)(\alpha - \theta)}{n+1} \right] (5)$$

Where, $n = 2k+1$ and $k = 1, 2, 3 \dots$

C. Error Adaptive Power Factor Controller

A pioneering work in the Error Adaptive Power Factor Controller [EAPFC] was done by M.A. El. Sharkawi et. al. [11, 12]. These EAPFC's do not make use of an inductor branch (TCR) as in SVC's but contributions to effective capacitor switching techniques are notable. The adaptive VAR compensation technology was developed at the University of Washington with sponsorship of Bonneville Power Administration (BPA) and Southern California Edison (SCE). The project was started in 1980 and ended in 1993. Subsequently related to this work number of papers were published [13, 14, 15, 16]. The major work was carried in the design, development and implementation of 15 kV class of adaptive VAR compensator. The Adaptive Var Compensator (AVC), was solid state switched, binary stepped capacitor bank, used to compensate any rapidly changing reactive demand within one half cycle without introducing transients or harmonics.

In the light of all the developments that have been reported in the recent past, the desirable features for the controller to be developed are listed below which forms the main theme of work under taken.

- It maintains the power factor at the PCC to any specified value.
- It compensates for rapid variation in reactive power or voltages.
- Maximum compensation time is 4 msec. (1/4 of a cycle).
- No transients or harmonics are allowed to be present due to fast selective instants of switching in a well coordinated manner.
- It is adaptive in the sense that the amount of the compensation is determined and provided on a cycle by cycle basis.
- It can compensate each phase independently which makes ideal for unbalanced systems.
- Capacitors are sized in binary sequential ratio for minimum size of switching steps.

The AVC can operate in any one of the following modes –

- Reactive Power Compensation (RPC) mode: Maintaining unity or other desired power factor at the point of common coupling (PCC) with an accuracy of smallest capacitor bit and with the limitation of total capacitance of the AVC per phase.
- Voltage support mode: Regulating the voltage at the point of or at some pre-specified level using under and/or over compensation.
- Flicker Control mode: Used to reduce the fast fluctuations in the voltage.

Any one of the modes can be implemented at a time and can be controlled by specified time scheduling [16]. The potential applications of AVC are at load end or at system level compensation. The load end application includes those requiring rapid compensation such as lumber mills, rock crushing plants, steel mills, elevators, arc furnaces, pumps, electric traction. The distribution system application includes reactive VAR compensation, enhancement of voltage regulation, and prevention of voltage collapse, released system capacity, reduction in line losses and increase in efficiency. The innovative and useful design of the AVC has resulted in commercialization of the device and reported in three US patents [13, 17, 18]. All the above referred controllers do not have any reactor part (TCR) as such. To maintain the power factor at unity, binary steps required are high to reduce the resolution. But still these APFC's are robust, controllers catering to the sudden changes in reactive power demand and reduce voltage flicker.

D. Processor Based Static VAR Compensators

In 1990, number of papers got published on microcontroller (Microprocessor) based static VAR compensator [19]. Also [20] gives the details of open loop control strategy of SVC; while in [19] hardware SVC model was developed for laboratory experiments. The model consists of FC-TCR

scheme. The control strategy used was based on PD & PID. The paper [20] focused specific inductor control (TCR) through developing a prototype model. While in [21, 22] fuzzy logic control scheme was used. The goal of this fuzzy controller was to provide maximum damping and improve stability in the power system.

II. BINARY SEQUENTIAL SWITCHED CAPACITORS AND TCR SCHEME

At the distribution transformer requiring total reactive power Q for improving the power factor from some initial value P_{f1} to the desired value P_{f2} at the load. This Q can be arranged in binary sequential 'n' steps, satisfying the following equation:

$$Q = 2^n C + 2^{n-1} C + + 2^2 C + 2^1 C + 2^0 C \quad (6)$$

The schematic diagram of the capacitor bank in five binary sequential steps through contactors and with respective current limiting reactors is shown in Fig 3. An innovative error adaptive controller is designed, developed and tested for switching operations of the capacitor bank as required for the system under consideration. It possesses the following features.

- The control strategy is error activated to match with the load reactive power for the chosen time interval.
- It eliminates possible over compensation and resulting leading power factor.
- It is flexible to choose required number of steps as per the resolution.
- Resolution can be made small with more number of steps.
- Simple in principle, elegant in usage and of low cost
- Possible to incorporate the idea presented in the controllers for large size transformers at substations.

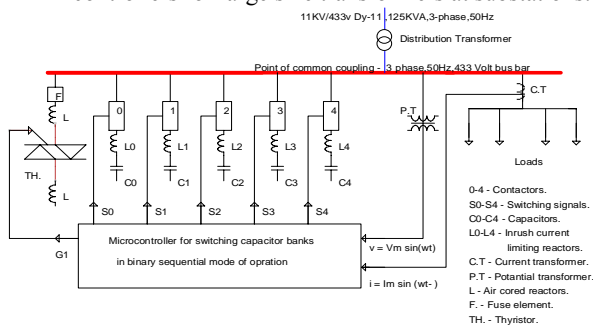

Fig. 2 Schematic diagram of capacitor banks switched through contactors/thyristors and in conjunction with TCR in delta

Fig. 3 Fig 2 schematic diagram of capacitor banks switched through contactors/thyristors and in conjunction with TCR in delta

The controller receives both current and voltage signals through CT and PT, perform necessary calculations through an in built program and generates the activating signals S₀, S₁, S₂, S₃ and S₄ so as to match the reactive power from the compensator with the prevailing load demand. It calculates the reactive power with a DSP based processor and arrives at the Q value and the corresponding steps to be kept on.

A. System Data for Experimental Set up

Walchand college of Engineering, Sangli is getting the supply from State Electricity Board through 11 KV feeders and there are two transformers feeding various loads in the campus. Their ratings are as follows:

11 KV feeders of length 5 km Vishrambag substation to college premises have the following parameters.

- Type of overhead line: -Mink 6/3.66
- Over all Diameter = 11 mm; Sectional area= 63.1 mm²;
- Approximate Weight = 254.9 Kg./Km.;
- Current Carrying Capacity = 174 A
- D.C. Resistance per Km distance =0.49 Ohms.
- Reactance per Km distance =0.365 Ohms

B. Analytical results

The adaption of binary sequential steps has reduced the resolution and when operated in conjunction with TCR, stepless control has been possible. The entire assembly consisting of capacitors, contactors, controller, thyristor controlled reactors, has been made as compact as possible. In particular the controller part is in modular form and can be made applicable for different ratings of compensators and even for high voltage application. Air cored coils are employed to avoid saturation, any deviation in L and large losses. The total losses taking place in capacitors and TCR are subtracted from the reduction in losses that has occurred in the transformer & feeder for calculating the net gain. Various load levels covering the entire range of the transformer chosen are covered at different power factors. The feeder parameters & transformer equivalent values are referred to LT side and the compensator performance is investigated. The results given in table I, II & III indicate the improvements brought out with the application of continuous control. The load current v/s receiving end voltage, load current v/s percentage voltage regulation, load current v/s feeder efficiency and load current v/s enhancement in feeder current carrying capacity are shown in Fig. 4, 5, 6 and 7. All these graphical characteristics bring out the technical advantages of SVC through the microcontroller. The analytical results obtained are verified with experimental results in the ensuing sections

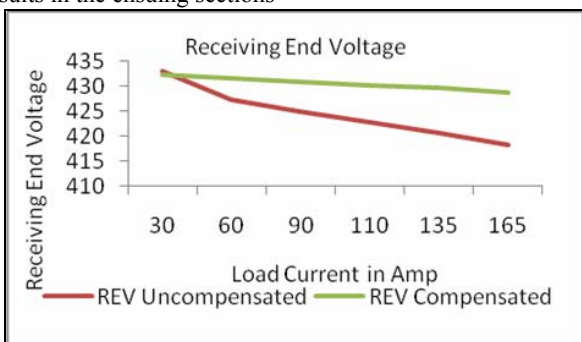

Fig 4 Plot of load current v/s receiving end voltage

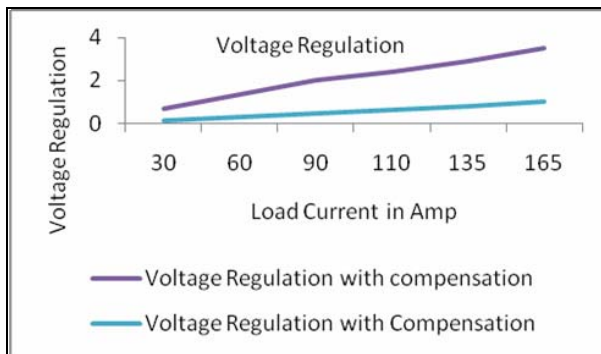

Fig.5 The plot of Load current v/s voltage regulation

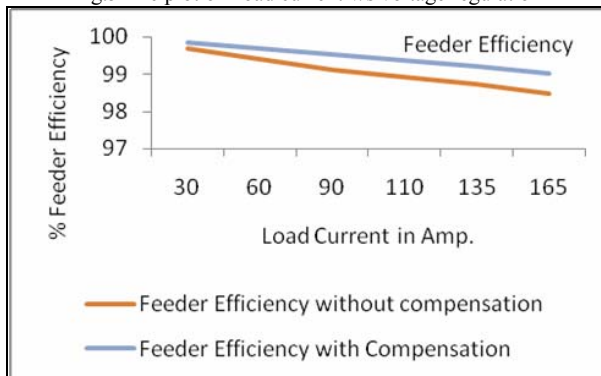

Fig.6 The plot of Load current v/s feeder efficiency

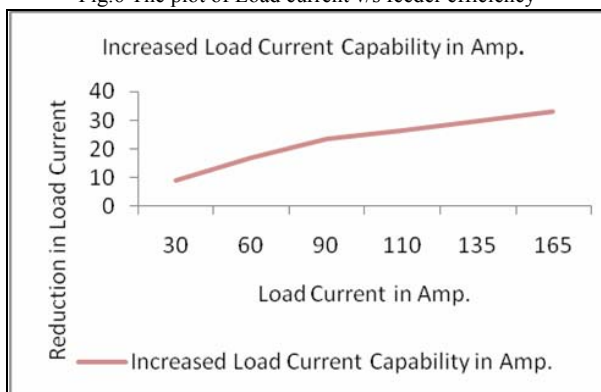

Fig.7 The plot of Load current v/s increase in current capability

II. HARDWARE IMPLEMENTATION

This section describes the various components for KVAR sensing used in the controller. The basic difference between SVC and proposed KVAR controller is that former handles the voltage regulation problem through TSC-TCR scheme while the latter performs smooth control with exact matching of reactive power resulting in improved voltage. This facilitates compensation of (lagging) reactive power by TSC-TCR scheme termed as SVC (KVAR controller). It includes KVAR sensor, ADC converter, zero crossing detectors, gate pulse generation for thyristor controlled reactor as well as capacitor switching ON/OFF circuit with the help of microcontroller 89C51. The general block diagram and its implementation in

TABLE I
DISTRIBUTION FEEDER PERFORMANCE WITHOUT COMPENSATOR

Sr. No.	Load Current Amp.	Power Factor Pf.	Real Power KW	Reactive Power KVAR	Apparent Power KVA	Receiving End Voltage Volts	Losses Watts	% Voltage Regulation	% Feeder Efficiency.
01	30.00	0.70	15.6	15.9	022.3	430.10	48.6	0.68	99.69
02	60.00	0.72	31.9	30.8	044.4	427.25	194.4	1.34	99.39
03	90.00	0.74	48.9	44.5	066.1	424.9	437.4	2.00	99.11
04	110.0	0.76	61.2	52.3	080.5	422.78	653.4	2.41	98.94
05	135.0	0.78	76.7	61.5	098.3	420.69	984.1	2.92	98.73
06	165.0	0.80	95.6	71.7	119.5	418.27	1470.1	3.52	98.48

TABLE II
KVAR COMPENSATION IN BINARY SEQUENTIAL STEPS FOR THE CASES REFERRED IN TABLE I

Sr. No.	Compensated Reactive Power KVAR in Binary sequential Steps					TCR Value KVAR Lag.	Reduced Current Amp.	Reduced Losses Watts	TCR + Capacitor Losses Watts	Net Losses TCR+Capacitor+Feeder losses Watts
	Q5	Q4	Q3	Q2	Q1					
01	-	-	10	5	2.5	1.6	21.00	23.8	47.9	71.17
02	-	20	10	-	2.5	1.7	43.20	100.8	55.9	156.7
03	40	-	-	5	-	00	66.60	239.5	3.75	243.25
04	40	-	10	-	2.5	0.2	83.60	377.4	5.12	382.52
05	40	20	-	-	2.5	1.0	105.30	598.8	24.4	623.2
06	40	20	10	-	2.5	0.8	132.00	940.9	18.45	959.35

TABLE III
RESULTS AFTER COMPENSATION FOR THE RESPECTIVE CASES OF TABLES I & II

Sr. No.	Receiving End Volts	% Voltage Reg.	% Feeder Eff.	Increased Load Current Capability Amp	Net Saving in Loss. Watts	Relief in KVA
01	432.3	0.15	99.84	9.00	-23	6.7
02	431.6	0.31	99.68	16.80	38	12.5
03	430.9	0.49	99.51	23.40	194	17.2
04	430.2	0.62	99.38	26.40	271	19.3
05	429.6	0.79	99.22	29.70	361	21.6
06	428.7	1.01	99.02	33.00	511	24.0

TABLE IV
SYSTEM PERFORMANCE WITHOUT SVC

Sr. No.	Avg. Load Current In Amp	Avg. P.F.	Avg. Voltage In volts	Active Power In Kw	Reactive Power In KVAR	Apparent Power In KVA	Percent Voltage Regulation	Losses In watts	Feeder Efficiency In %
1	30	0.8	430	17.9	13.4	22.36	0.66	48.6	99.69
2	60	0.82	428	36.4	25.35	44.35	1.16	194.4	99.39
3	90	0.83	426	55.1	37.19	66.48	1.63	437.4	99.11
4	110	0.83	424	67.0	45.24	80.84	2.09	653.4	98.94
5	135	0.84	422	82.8	53.28	98.46	2.56	984.1	98.73
6	150	0.85	419	92.5	56.6	108.44	3.25	1215	98.48

TABLE V
SYSTEM PERFORMANCE WITH SVC

Sr. No.	Load Current In Amps	Capacitor Bank steps Used	TCR Value KVAR	TCR Current Amps	Line Losses In watts	PCC Voltage In Volts	Percent Voltage Regulation	Feeder Efficiency In %	Increased Load Capability In Amps	KVA Relief
1	24	10+5	1.6	2.5	31	432	0.23	99.8	6	4.46
2	49	20+5	0.0	0.1	130	431	0.46	99.27	11	7.95
3	74	20+10+5+2.5	0.39	0.5	295	430	0.69	99.15	16	11.38
4	91	40+5	0.0	0.1	447	429	0.9	99.00	19	13.84
5	113	40+10+5	1.62	2.7	689	428	1.15	98.9	22	15.66
6	127	40+10+5+2.5	0.9	1.5	870	426	1.61	98.8	23	15.94

the form of a TSC-TCR type SVC on 11KV/433V, DY11, 125KVA, 3phase, 50Hz transformer at Walchand College of Engineering, Sangli has been shown in Fig. 8.

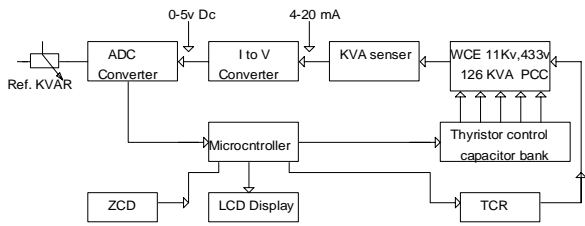

Fig.8 Schematic diagram of SVC controller

A. General Schematic Diagram of SVC:

At the point of common coupling, on the 125 KVA transformer, all the laboratory loads are connected. The actual KVAR at PCC is found by sensing current and voltage through CT and PT. This KVAR sensor gives the output current signal in the range of 4-20mA. Then by using I to V converter current signal is transformed in to 0-5 volts d. c. and given to ADC, which ultimately converts this signal in to digital signal compatible for acceptance by microcontroller. Based upon this KVAR value, switching of capacitor bank steps takes place. The excess leading KVAR is absorbed by TCR block for which firing angle (α) timings are generated by microcontrollers. Details of each block are explained in the following sections. At the point of common coupling, on the 125 KVA transformer, all the laboratory loads are connected. The actual KVAR at PCC is found by sensing current and voltage through CT and PT. This KVAR sensor gives the output current signal in the range of 4-20mA. Then by using I to V converter current signal is transformed in to 0-5 volts d. c. and given to ADC, which ultimately converts this signal in to digital signal compatible for acceptance by microcontroller. Based upon this KVAR value, switching of capacitor bank steps takes place. The excess leading KVAR is absorbed by TCR block for which firing angle (α) timings are generated by microcontrollers.

The measuring system provides necessary inputs for SVC controller to initiate appropriate control actions. The generation of a VAR signal is based upon sensing the reactive power either by 3-phase 3-wire or 3-phase 4-wire system through CTs of 300/5 Amp and voltage signals. The CORNEL4380 is a multifunction meter which displays the various parameters after measuring for monitoring purpose as follows. It has two analog outputs of 0-1mA and 0-20mA which can be programmed to provide as lead/lag and KVAR signal. This 4-20 mA current KVAR signal can be converted into 0-5 V d. c. signal. The 4-30 mA current signals obtained through sensor is converted into 0-5 volt d. c. by using I-V converters. This 0-5 volt d. c. signal is proportional to 0-100 KVAR lagging. This analog signal is once again converted to digital by using 0808 ADC.

B. Thyristor Controlled Reactor(TCR)

The designed air cored reactors are connected in delta as shown in Fig 9. Instead of thyristors, phase controlled solid state relays (SSR's) are used. The two coils are arranged in series, so that applied line voltage of 440 V is divided in to 220 volts each. As the firing angle increases beyond 85° by an angle α , the magnitude of fundamental component I_α goes on varying as per "(5)". Lagging KVAR is calculated by microcontroller and from lookup tables stored in the memory corresponding firing angle α is obtained. The lookup table provides the information regarding required KVAR and the corresponding firing angle α .

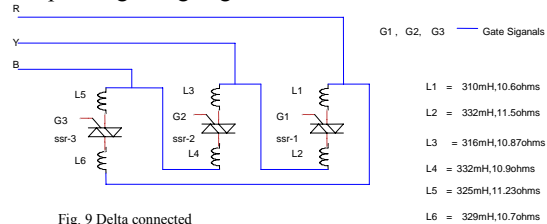

Fig. 9 Delta connected

The output of ADC varies from 00h to FFh for input variation of 0-5 volt d. c. (i. e. 100 KVAR lag) this numerical hex value gives the exact requirement of leading KVAR. This value of KVAR is used for capacitor switching strategy. Resultant switched capacitor KVAR is purposely kept on the leading side. This leading KVAR is then compensated by adjusting the conduction duration σ in the thyristor controlled reactor. The capacitor banks are arranged in binary sequence form i. e. in the multiplicity of 16, 8, 4, 2, 1 code. Therefore, $C_5 = 16C_1$; $C_4 = 8C_1$; $C_3 = 4C_1$, and $C_2 = 2C_1$ with basic unit of 2.5 KVAR.

III. EXPERIMENTAL RESULTS

All the above components are fabricated, tested and implemented at PCC of a 125 KVA, 433 volts distribution transformer. The load was increased from 30 Amp to 150 Amp. It is observed that without controller p.f. varies from 0.8 to 0.85 while with developed static Var compensator, it was in between 0.99 lag to 0.99 lead. The details of the system performance with and without SVC are given in the Table IV and V respectively. The voltage improvement, reduction in regulation, reduction in feeder losses, efficiency of feeder and relief obtained in KVA demand are depicted in Fig. 10 to Fig. 13 respectively.

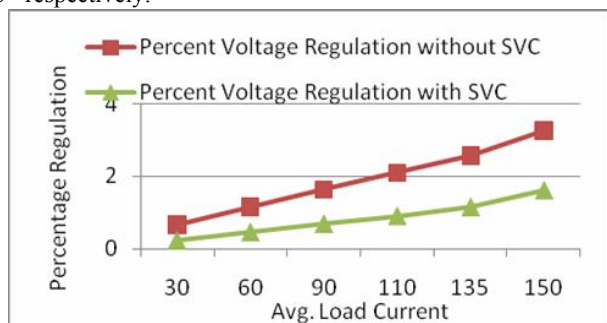

Fig. 10 Voltage Regulation

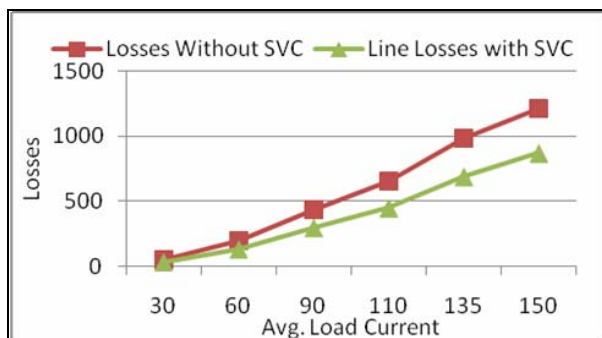

Fig. 11 Feeder Losses with and without SVC

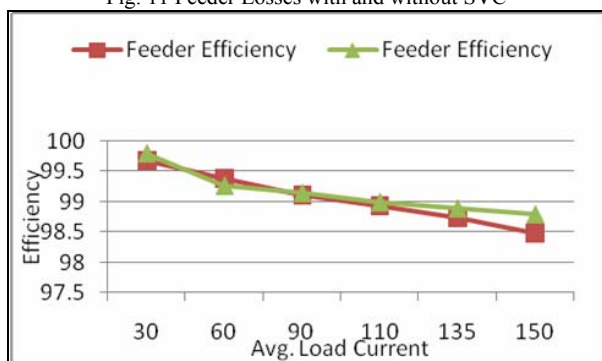

Fig. 12 Feeder Efficiency

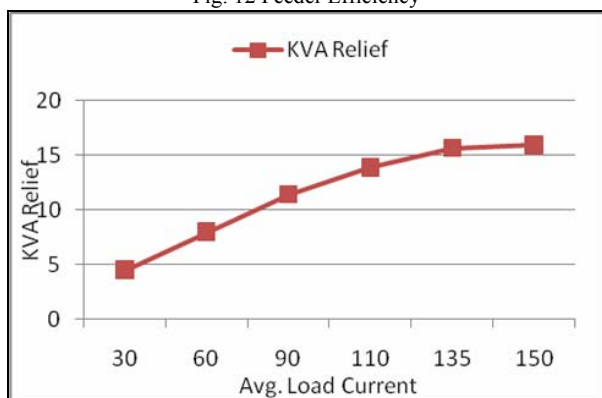

Fig. 13 KVA Relief with SVC

Economic Justification:

In the college campus installation state electricity boards has been imposing penalties due to poor power factor and excessive maximum demand. The scheme that is proposed eliminates these penalties and college can avail the benefits of incentives by maintaining the power factor nearer to unity. On an average the college is paying the penalties to the tune of Rs 25000/- per month. The overall installation cost of the proposed scheme is of around Rs/- 1.2 lakh. Monthly savings due to incentives offered by state electricity boards for improvement in the power factor from .96 to unity p.f. is of 5 to 6 % of the monthly bill. The average monthly bill is around 5 lakh. Hence straight way monthly incentives obtained are of around 17,000/-. Also incentives are obtained due to reduction in maximum demand charges approximately Rs. 3000/-. Therefore the payback period comes out to be of 6 months for the system installed.

IV. CONCLUSION

A comprehensive static VAR compensator consisting of capacitor bank in five binary sequential steps in conjunction with a thyristor controlled reactor of smallest step size is employed in the investigative work. The work deals with the performance evaluation through analytical and practical implementation on an existing system. It is successfully tested on a distribution transformer of three phase 50 Hz.

Dy11, 11KV/440V, 125 KVA capacity. Theoretical and practical results are matching with each other. It gives the following benefits:

- Maintaining the power factor at unity.
- Minimum feeder current and loss reduction.
- Improvement in distribution feeder efficiency.
- Improvement in the voltage at load end.
- Relief in maximum demand and effective utilization of transformer capacity.
- Saving in monthly bill due to reduction in penalty on account of poor power factor, and reduction in maximum demand charges.
- Conservation of energy takes place.
- It is possible to get stepless control of Q closely matching with load requirements.
- The combination offers greater flexibility in control.
- There is substantial reduction in harmonics generated due to small size of reactor employed in the static VAR compensator.

REFERENCES

- [1] Hammad and B. Roesle, "New roles for static Var compensators in transmission system", Brown Boveri Rev., Vol. 73, pp 314-320, Jun. 1986.
- [2] J. Kearly et. al., "Microprocessor controlled reactive power compensator for loss reduction in Rural Distribution Feeders", IEEE Transactions on power delivery, Vol. 6, No. 4, October 1991, pp. 1848-1855.
- [3] Narain G. Hingorani and L. Gyugyi, "Understanding FACTS" IEEE Press.
- [4] K. Stahllleopf, M. Wichelm, "Tighter Controls for Busier System", IEEE Spectrum, April 1977, P 49-52.
- [5] J. Grahm, "Transient stability enhancement using Static Var Compensation", Wart Virginia University, Thesis, 378, 3543 Engg. G76tc2, Oct. 1995.
- [6] L. Gyugyi, R. A. otto, T. H. Putman, "Principles and Application of Static Thyristor Controlled Shunt Compensations", IEEE Transaction on Power Apparatus and Systems", Vol. PAS 97, No. 51978, pp 1935-1945.
- [7] Celli, F. Pilo, S. B. Tennakoon, "Voltage Regulation on 25 KV A. C. Railway Systems by Using Thyristor Switched Capacitors", 0-7803-6499-6/00 2000 IEEE.
- [8] Edwards, K. Mattern, E. Stacey, P. Nannery and J. Gubernick, "Advanced static Var generator employing GTO thyristors", IEEE Trans. Power Del. VOL. 3, No. 4, pp1622-1627, Oct. 1988.
- [9] M. F. Izzary, Silvestrini, PREDA mitigation of back to back capacitor switching transients on distribution circuits, San Juan PR00936.
- [10] Turan Gonen, "Electric power distribution system engineering", CRC press, 2nd edition.
- [11] M. El. Sharkawi, T. Williams, N. Buller, "An Adaptive Power Factor Controller for Three Phase Induction Generator", IEEE tranction on Power App and Systems, Vol. PAS 104, No. 7, July 1985, pp1825-1831.
- [12] El. Sharkawi, N. Buller, R. Yinger, "Development and Field testing of adaptive power factor controller, IEEE tranction on energy conservation, Vol. EC-2, No. 4, alce 1987.

- [13] Sharkawi, S. S. Vankuta, G. Andexler, Mingliang chen and Tony Huang, "Reactive Power Compensation", us patent No. 5, 134, 356 July 28, 1992.
- [14] Bradley, J. A. Turner, D. S. Krchbial, "Lighting impuler test on adaptive power factor controller", US Department of Engg-Bonneville power administration report No. ERJ 83-82, Sept. 23, 1983.
- [15] S. Cherulaupalli, H. E. Orton, "Adaptive power factor controller" powertect Enc. Project No. 148-88, No. 1988.
- [16] M. A. El Sharkawi Et. al., "Development and field testing of adaptive flicker control for 15 KV systems", paper number 94 sm 453-1 PWRD, PES summer meeting, San Fransco, July 25-28, 1994.
- [17] Sharkawi, S. S. Vankuta, G. Andexler, Mingliang chen and Tony Huang, "Reactive Power Compensation", us patent No. 5, 134, 356 July 28, 1992.
- [18] Bradley, J. A. Turner, D. S. Krchbial, "Lighting impuler test on adaptive power factor controller", US Department of Engg-Bonneville power administration report No. ERJ 83-82, Sept. 23, 1983.
- [19] S. Cherulaupalli, H. E. Orton, "Adaptive power factor controller" powertect Enc. Project No. 148-88, No. 1988.
- [20] Paul, S. Basu, R. Mondal, "A Microcomputer Controller static var compensator for power system laboratory experinemnts", IEEE transaction on power systems. Vol. 7, No. 1, Feb. 1992, p. 371-376.
- [21] A Exporito, F. Varquez, C. Mitchell, "Microprocessor based control of a SVC for optimal load compensation", IEEE Transactions on power delivery, Vol. 7 No. 2, April 1992.
- [22] Hiyama, W. Hubbi, T. Ortmeyer, "Fuzzy logic control scheme with variable geiin for static var comepensator to enhance power system stability", IEEE transactions on power systems, Vol. 14, 1 Feb. 1999, P186-191.