

Simulation and Measurement the Radiation of an Antenna inside a Metallic Case using FDTD

Shabnam Ladan, and M. S. Abrishamian

Abstract—In this paper we have developed a FDTD simulation code which can treat wave propagation of a monopole antenna in a metallic case which covers with PML, and performed a series of three dimensional FDTD simulations of electromagnetic wave propagation in this space. We also provide a measurement set up in antenna lab and fortunately the simulations and measurements show good agreement. According to simulation and measurement results, we confirmed that the computer program which had been written in FORTRAN, works correctly.

Keywords—FDTD, EMC, monopole antenna.

I. INTRODUCTION

THE problem of electromagnetic waves penetration and interference is one of the most challenging discussions considered by many EMC experts. The increasing usage of highly sensitive electronic instruments is one of effective factors in making the problem of protection such crucial. It is predictable that future interests will tend to find shielding strategies that are efficient, reliable and yet simple and inexpensive. Recent researches have shown that studying the mechanism of EM wave penetration into different physical structures can provide simple and inexpensive shielding strategies improving shielding effectiveness of complex systems such as work rooms loaded with equipment even before embarking on elaborate and costly shielding methods [1, 2].

In this paper Finite Difference Time Domain technique has been used to achieve a full wave analysis of electromagnetic wave from monopole antenna installed in a metallic case with an aperture. Also a measurement set up is provided to measure the emission of this monopole antenna. In Fig. 1 the model which is used in simulation is shown.

II. FDTD MODELING

FDTD is a common method where impulse response of an electromagnetic system is simulated in time domain. Output of the simulation is transformed into frequency domain, because measuring instruments work in this domain, and the behaviour of the systems depends highly on frequency due to the resonant structures of the systems.

Authors are with Iran Telecommunication Research Center (ITRC), Research Engineering, P.O. Box: 3961-14155, Iran (phone: +98 21 22071793; e-mail: habnamladan@mail.itrc.ac.ir).

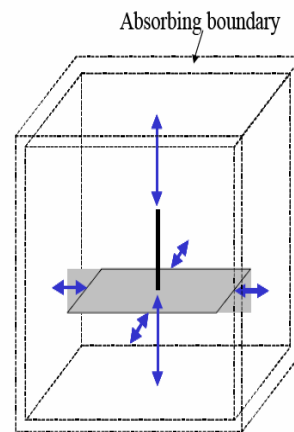

Fig. 1 3D view of model used in simulation

If the geometry of the system that is tested is fully known, propagation of the impulse through the system can be simulated by FDTD through discretized Maxwell equations by computing the electric and magnetic fields, one following another, through two consecutive grids. As the system under 'test gets bigger, the simulation becomes computationally unaffordable. Namely, the shielding property of an enclosure might need to be simulated for as long as several weeks.

In this paper the method which is used is Yee method. In this method the simulation environment is divided into small cells and the dimension of the cell is $\Delta x = \Delta y = \Delta z = \Delta$. In Fig. 2 the structure of this method is shown.

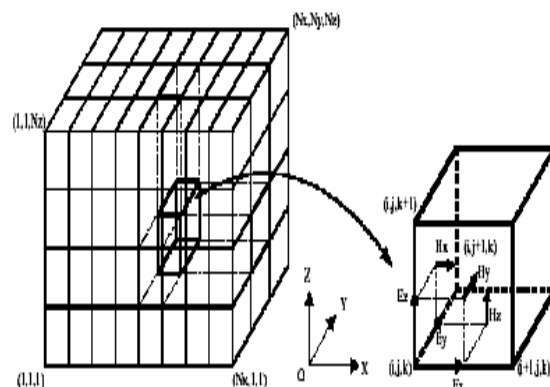

Fig. 2 Yee cell which is used in the simulation

In this structure each point is located in:

$$(i, j, k) = (i\Delta x, j\Delta y, k\Delta z) \quad (1)$$

This method is based on Maxwell equations and the number of cell in each directed is N_x , N_y and N_z . The symbol n shows the number of time step, so the electric and magnetic fields are calculated from these equations:

$$H_x^{n+1/2}(i, j, k) = H_x^{n-1/2}(i, j, k) - \frac{dt}{\mu_0 dy} (E_z^n(i, j+1, k) - E_z^n(i, j, k)) + \frac{dt}{\mu_0 dz} (E_y^n(i, j, k+1) - E_y^n(i, j, k)) \quad (2)$$

$$H_y^{n+1/2}(i, j, k) = H_y^{n-1/2}(i, j, k) - \frac{dt}{\mu_0 dz} (E_x^n(i, j, k+1) - E_x^n(i, j, k)) + \frac{dt}{\mu_0 dx} (E_z^n(i+1, j, k) - E_z^n(i, j, k)) \quad (3)$$

$$H_z^{n+1/2}(i, j, k) = H_z^{n-1/2}(i, j, k) - \frac{dt}{\mu_0 dx} (E_y^n(i+1, j, k) - E_y^n(i, j, k)) + \frac{dt}{\mu_0 dy} (E_x^n(i, j+1, k) - E_x^n(i, j, k)) \quad (4)$$

$$E_x^{n+1}(i, j, k) = E_x^n(i, j, k) + \frac{dt}{\epsilon_0(i, j, k) dy} (H_z^{n+1/2}(i, j, k) - H_z^{n-1/2}(i, j-1, k)) - \frac{dt}{\epsilon_0(i, j, k) dz} (H_y^{n+1/2}(i, j, k) - H_y^{n-1/2}(i, j, k-1)) \quad (5)$$

$$E_y^{n+1}(i, j, k) = E_y^n(i, j, k) + \frac{dt}{\epsilon_0(i, j, k) dz} (H_x^{n+1/2}(i, j, k) - H_x^{n-1/2}(i-1, j, k)) - \frac{dt}{\epsilon_0(i, j, k) dx} (H_z^{n+1/2}(i, j, k) - H_z^{n-1/2}(i, j-1, k)) \quad (6)$$

$$E_z^{n+1}(i, j, k) = E_z^n(i, j, k) + \frac{dt}{\epsilon_0(i, j, k) dx} (H_y^{n+1/2}(i, j, k) - H_y^{n-1/2}(i, j-1, k)) - \frac{dt}{\epsilon_0(i, j, k) dy} (H_x^{n+1/2}(i, j, k) - H_x^{n-1/2}(i, j, k-1)) \quad (7)$$

For achieving to acceptable results, it is necessary to have:

$$dx, dy, dz < \frac{\lambda_{\min}}{\sqrt{\epsilon_r} \cdot f_{\max}} \quad (8)$$

f_{\max} is the maximum frequency and λ_{\min} is the minimum of wavelength which is used in simulation.

In order to have a stable simulation result, we must assign:

$$dt \leq \frac{1}{C} \frac{1}{\sqrt{\frac{1}{dx^2} + \frac{1}{dy^2} + \frac{1}{dz^2}}} \quad (9)$$

That C is the speed of light [2].

III. NUMERICAL RESULT

In this paper the simulation is done for a metallic case. Case dimensions are 25 cm×25 cm×10 cm. The electric and magnetic fields are equalled to zero in the bounds and a monopole antenna is installed in the metallic case. The outer space is terminated in a 8-layer perfectly matched layer with graded profile and optimum conductivity as described in [3]. This simulation is done in three states:

1. A case with one aperture
2. A case with two apertures
3. A case with three apertures

1. Case with one aperture

In this condition the case has one aperture which installed on the front wall and its dimensions are 5 cm × 5 cm. The monopole antenna is triggered with the Gaussian pulse waveform:

$$g(t) = k e^{-(t-t_0)2/T2} \quad (10)$$

with $k = 103$, $T = 0.5 \times 10^{-9}$ and $t_0 = 2 \times 10^{-9}$.

The simulation is done in $f_0 = 3$ GHz. In Fig. 3 the simulated case is shown.

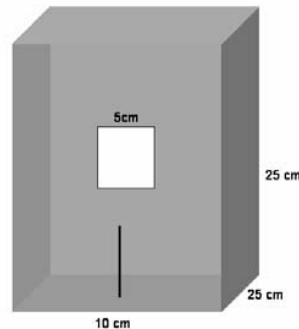

Fig. 3 Case with one aperture

The electromagnetic fields in E plane and H plane from the antenna in the above case are shown in Figs. 4 and 5.

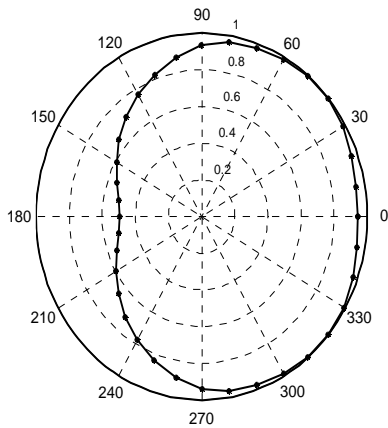

Fig. 4 Pattern of the monopole antenna in case with one aperture in H plane at $f_0 = 3$ GHz

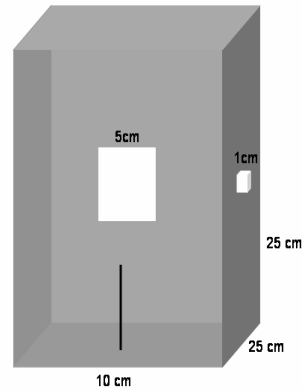

Fig. 6 Case with two apertures

The electromagnetic fields in E plane and H plane from the antenna in this case are shown in Figs. 7 and 8.

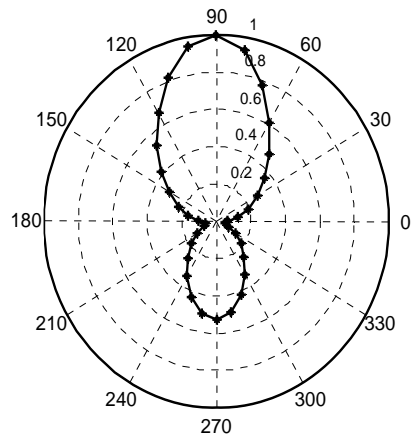

Fig. 5 Pattern of the monopole antenna in case with one aperture in E plane at $f_0 = 3$ GHz

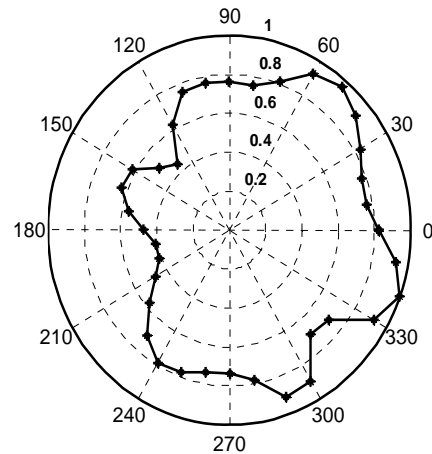

Fig. 7 Pattern of the monopole antenna in case with two apertures in H plane at $f_0 = 3$ GHz

2. Case with two apertures

In this state the metallic case has two apertures which installed on the front wall and right wall and their dimensions are $5\text{ cm} \times 5\text{ cm}$ on front wall and $1\text{ cm} \times 1\text{ cm}$ on right wall. The other conditions are the same which described for case with one aperture. In Fig. 6 the simulated case with two apertures is shown.

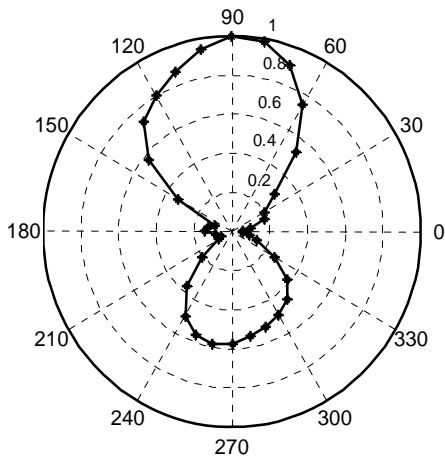

Fig. 8 Pattern of the monopole antenna in case with two apertures in E plane at $f_0 = 3$ GHz

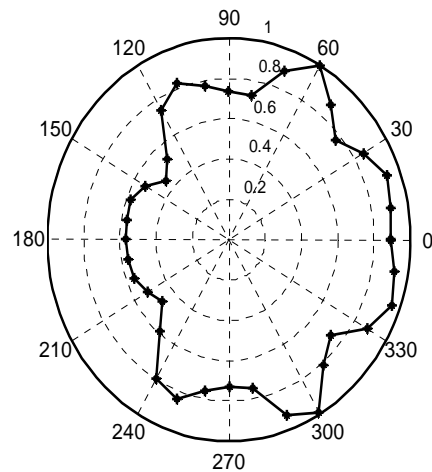

Fig. 10 Pattern of the monopole antenna in case with three apertures in H plane at $f_0 = 3$ GHz

3. Case with three apertures

In this state the metallic case has three apertures which installed on the front wall and right wall and left wall and their dimensions are $5\text{ cm} \times 5\text{ cm}$ on front wall and $1\text{ cm} \times 1\text{ cm}$ on right wall and left wall. The other conditions are the same which described for cases with one aperture and two apertures. In Fig. 9 the simulated case with three apertures is shown.

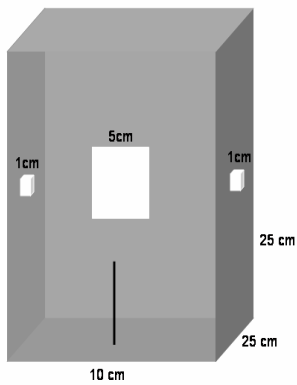

Fig. 9 Case with three apertures

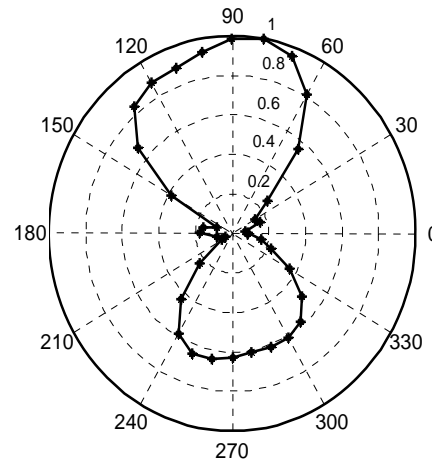

Fig. 11 Pattern of the monopole antenna in case with three apertures in E plane at $f_0 = 3$ GHz

IV. CALCULATE THE IMPEDANCE

In this part the impedance of monopole antenna installed in the metallic case with one aperture is calculated and in Fig. 12 the result of this calculation is shown.

The electromagnetic fields in E plane and H plane from the antenna in the case with three apertures are shown in Figs. 10 and 11.

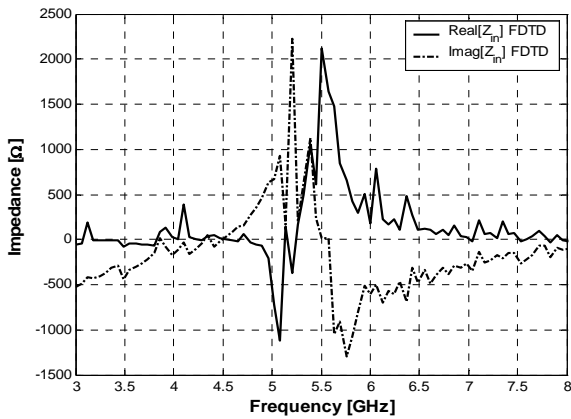

Fig. 12 The Impedance of monopole antenna installed in metallic case with one aperture

As you see in Fig. 12 there are some peaks and deeps in the impedance, and these peaks and deeps are created because of resonant frequencies of metallic case which interference with the frequency of the monopole antenna.

V. MEASUREMENT RESULT

In this paper we have also provided a measurement set up in the antenna lab and measured a real case that has an aperture and a monopole antenna is installed in it. In Fig. 13 the case is shown.

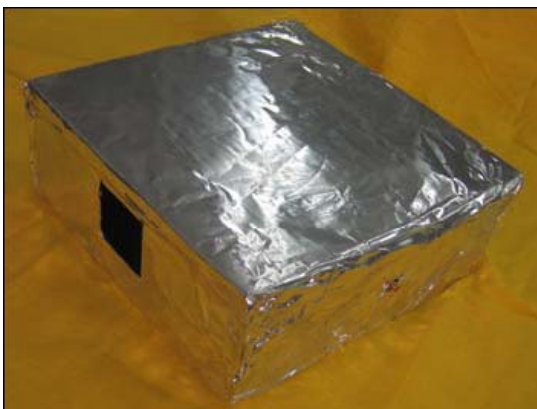

Fig. 13 The case with one aperture which is used in measurement

In the lab, the pattern of monopole antenna was measured for a range of frequencies between 2.9 GHz to 2.99 GHz. As the results showed, because of some leakages from the walls of case, the patterns were so sensitive to frequency changing. In figure 14 and 15 the patterns of monopole antenna at $f_0 = 2.97$ and $f_0 = 2.93$ are shown and it can be seen by changing the frequency just a little, the patterns shape change a lot.

It must be said that it is impossible to get the equal result in simulation by computer and real conditions in the lab. Because in simulation by the computer all the condition are ideal and there is no noise but in the lab we face to a real environment that has noise. But in a good condition we can get an acceptable result.

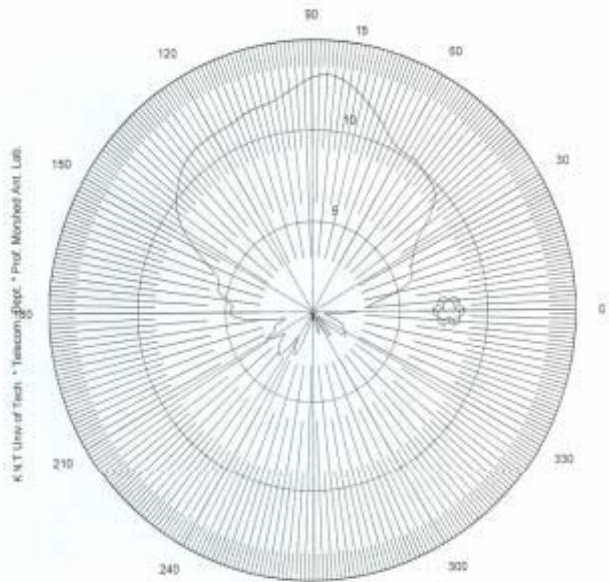

Fig. 14 Pattern of the monopole antenna in case with one aperture at $f_0 = 2.97$ GHz

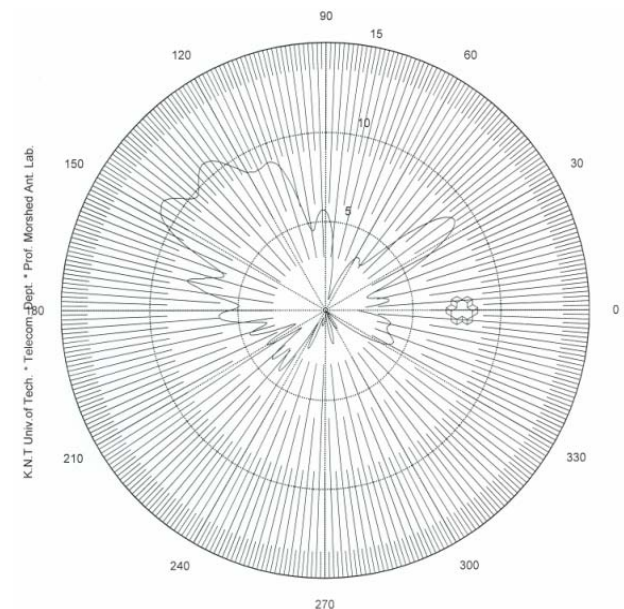

Fig. 15 Pattern of the monopole antenna in case with one aperture at $f_0 = 2.93$ GHz

In Fig. 16 the comparison of simulation result and measurement result has been shown at $f_0 = 2.97$ GHz.

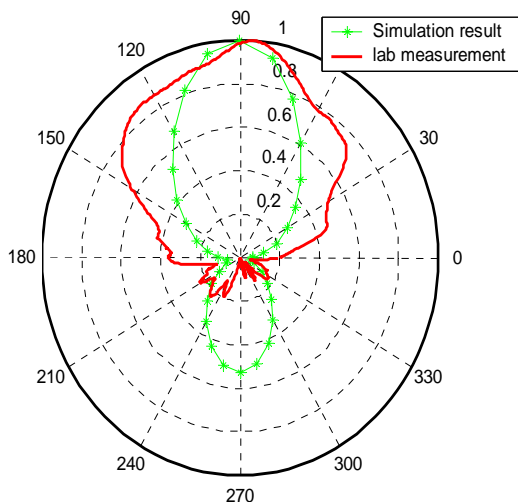

Fig. 16 Comparison of simulation result and measurement result at $f_0 = 2.97$ GHz

VI. CONCLUSION

In this paper we have developed a FORTRAN code which can calculate the radiation pattern and impedance of a monopole antenna installed in a metallic case in three conditions. According to the result of simulation we can conclude that by increasing the number of apertures the radiation of monopole antenna is increased and the patterns are getting far from the patterns of monopole antenna in free space. By calculating the impedance we can choose the best frequency for working. The best frequency is a frequency that antenna has a large real part and small imagine part.

It must be said this FORTRAN code is flexible for simulating another structures such as shielding rooms, computer case, cars and etc. and by using this code for different case we can get the best result in selecting the frequency for working.

ACKNOWLEDGMENT

The authors would like to thank Iran Telecom Research Centre (ITRC) for its financial and scientific support.

REFERENCES

- [1] A. Chaldavi, GH. Rezaee "Introduction to EMC".
- [2] Matthew N. O. Sadiku "Numerical Techniques in Electromagnetics" CRC Press 2000.
- [3] Karl S. Kunz "Finite Difference Time Domain Methode for Electromagnetics" CRC press 1993.
- [4] Taflove, A., Hagness, S.C., Computation Electrodynamics: The Finite-Difference Time-Domain Method, Artech House, Norwood, MA, 2000.
- [5] Berenger, J. P., "Perfectly matched layer for the absorption of electromagnetic waves," Journal of Computational Physics, Vol. 114, 185-200, 1994.