

The Analysis of Photoconductive Semiconductor Switch Operation in the Frequency of 10GHz

Morteza Fathipour*, Seyed Nasrolah Anousheh*, Kaveh Ghiafeh Davoudi*, Vala Fathipour*

Abstract—A device analysis of the photoconductive semiconductor switch is carried out to investigate distribution of electric field and carrier concentrations as well as the current density distribution. The operation of this device was then investigated as a switch operating in X band. It is shown that despite the presence of symmetry geometry, switch current density of the on-state steady state mode is distributed asymmetrically throughout the device.

Keywords—Band X, Gallium-Arsenide, Mixed mode, PCSS, Photoconductivity.

I. INTRODUCTION

APPLICATION of Photoconductive Semiconductor Switch (PCSS) in the field of Transducer and Receiver modules up to GHz frequencies, is highly desirable. In particular several studies have been carried out to investigate the capability of PCSS in high frequency applications, such as new generation of arrayed-radar [3, 4].

To transfer the maximum power to the load, one of the most important factors is Transmit/Receive (T/R) module. Often the model of class AB microwave amplifier is used for output module (T/R) which ideally predicts 78.5% efficiency. However in X -frequency bands it is just 20% efficiency in practice. The major factor for non-ideal behavior in these amplifiers is the power loss in the switching transistors. To

M. Fathipour is the head of the Device and Simulation Lab., he is an IEEE member and the associate professor of the Department of Electrical and Computer Engineering of the University of Tehran, P.O. Box 14395-515, Tehran, Iran (corresponding author to provide mobile: (+98 912) 147 32 09; phone: (+98 21) 88 02 04 03; e-mail: mfathi@ut.ac.ir).

Seyed Nasrolah Anousheh is the postgraduate student of the Department of Electrical and Computer Engineering of the Islamic Azad University— Central Tehran Branch, Tehran, Iran (corresponding author to provide mobile: (+98 917) 711 06 88; phone: (+98 21) 44 32 55 82; e-mail: anoshe2000@gmail.com).

Kaveh Ghiafeh Davoudi is the postgraduate student of the Department of Electrical and Computer Engineering of the Islamic Azad University— Central Tehran Branch, Tehran, Iran; e-mail: K.G.Davoodi@gmail.com).

Vala Fathipour is with the Device and Simulation Lab., an IEEE member and is the postgraduate student of the Department of Electrical and Computer Engineering of the University of Tehran, P.O. Box 14395-515, Tehran, Iran (e-mail: valafathi@gmail.com).

*This research was carried out at the Device Modeling and Simulation Laboratory of the Department of Electrical and Computer Engineering of the University of Tehran.

overcome this limitation a light activated switch may be employed rather than gate controlled device [4].

The operation of PCSS as a circuit element operating in class AB power amplifier was outlined by [2, 3, 4]. Here we intend to focus of this device for operations in the frequency of 10 GHz. In section II we explained models used in device simulation. In section III the device geometry and the appropriate circuit is discussed. We provide analysis of PCSS in the on-mode in section IV and some aspects of operation of this device is described. Finally in section V, we provide a conclusion.

II. SIMULATION SOFTWARE

Numerical simulation using a two dimensional software was carried out. Since GaAs is a direct band gap material, band to band recombination model was employed. Recombination at high concentration of carries involve Auger recombination too, and also appropriate model for light generation of carriers is employed in this study [1].

III. DEVICE, DIMENSION OF SIMULATION AND THE CIRCUIT:

In the new issues of X-frequencies band, the circuits like figure 1 is substituted by class AB microwave. In this figure (Fig. 1) PCSS s are substituted by transistors [3].

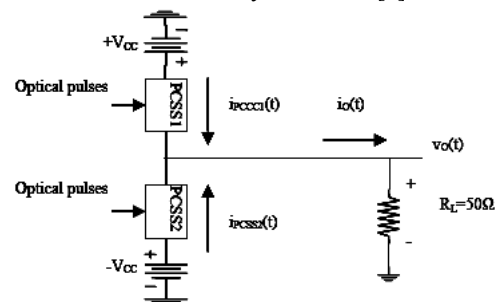

Fig. 1 Schematic of the optoelectronic Class AB microwave power amplifier [3]

The half circuit for the optoelectronic microwave power amplifier class AB included as 10V voltage source and a 50Ω resistor and the PCSS (Fig. 2). The reason of using half of circuit is the symmetry existed in each front and below circuit parts. In circuit shown in figure 2, the applied PCSS is a GaAs bulk device with a donor density equal to 10^{12} donors/cm. GaAs is a direct band gap III V compound and provides a high

breakdown voltage and it is thus suitable for use as PCSS element.

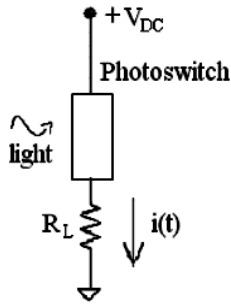

Fig. 2 Circuit used to simulate the optical pulse response of the PCSS [3]

For this application, PCSS has a length of $0.5\mu\text{m}$ (L), width of $20\mu\text{m}$ (w) and depth of $5\mu\text{m}$ (d). The contacts were assumed to be Schottky type with a work function of 4.37eV . This reduces the carrier injection at low voltages [2]. Basic geometry for the PCSS is given in figure 3.

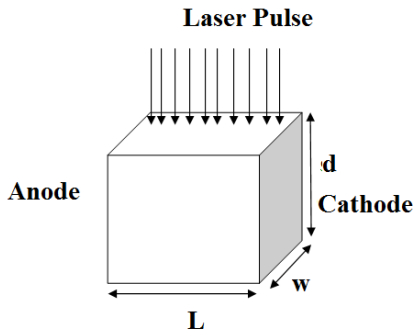
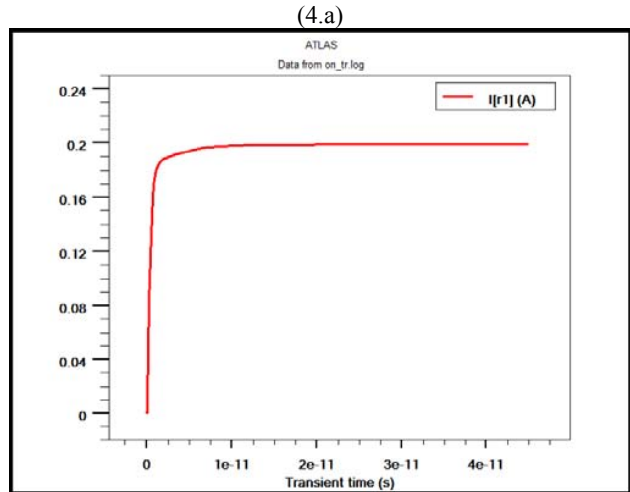
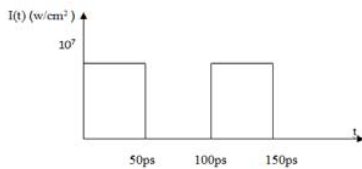

Fig. 3 Basic PCSS geometry.

The applied laser pulse is a square shaped pulse and has a 50% duty cycle at 10GHz frequency band. Laser optical pulse is shown in Fig. (4.a). Fig 4.b shows current through load resistor (I_R) as a function of time. The turn on time calculated from this figure is around 4.8ps . The optical power peak (P_0) is proportional to the peak Intensity (I_0) and is

$$P_0 = I_0 w L \tag{1}$$

So here P_0 becomes 1 watt.



(4.b)

Fig. 4

(4.a) Laser optical pulse for activation

(4.b) I_R as a function of time till 45ps

IV. ANALYSIS OF PCSS DURING TURN-ON MODE

Designed PCSS for the GHz frequency range had a turn on time of 4.8ps (Fig. 4.b), which after this time is going to obtain steady state of on-mode and we can study the behavior of device before reaching 50ps , which is a time that light being removed from the surface of device, hence the time of 45ps is selected to watch the operation of device (Fig. 4.b).

A. Carrier distribution

Fig. (5.a) shows electrons and holes as the electric field in the on-state of switch at a depth of $1\mu\text{m}$. In Fig. (5.a) the left electrode is taken as anode and the right side electrode is cathode which is connected to load resistor. As we see in this figure concentration of electrons and holes in the center of device length reaches its maximum. At both sides of device where concentration of both carriers reaches its minimum, electric field attains its maximum. In Fig. (5.b) distribution of the electron and whole concentrations as well as recombination rate, was shown. It is observed that the recombination rate is maximum in the device center at $0.25\mu\text{m}$ length. This may be attributed to the fact that concentration of electron and hole is the largest at that point.

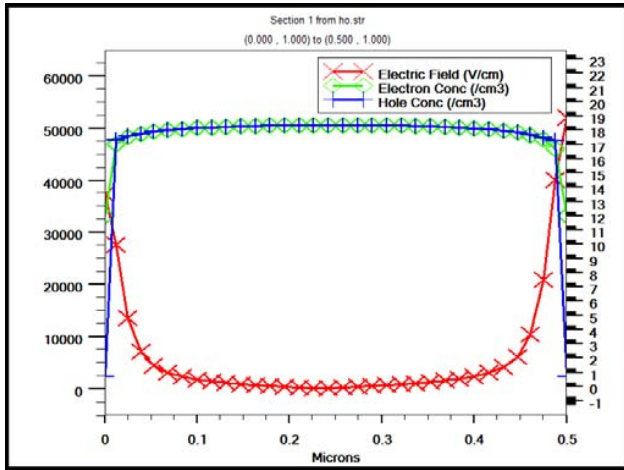

(5.a)

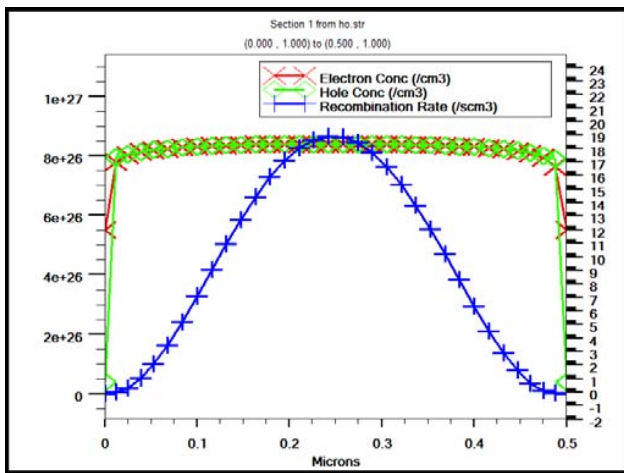

(5.b)

Fig. 5

(5.a)Carrier distribution as well as the electric field
(5.b) recombination rate and carrier distribution

B. Analysis of electric field

In figure 2, applied voltage is 10V and the distance between two electrodes is 0.5um .Maximum of electric filed is 200kv/cm which is lower than 300kv/cm, breakdown electric field of GaAs [5].

As stated earlier, the electric field in the on-state is small in the middle of device thus the voltage drop across the PCSS is quite small , we may thus conclude resistance of the PCSS in the on-state is much lower than R_L .

C. Analysis of Recombination Rate and Photo-generation Rate:

We would expect the rate of the band to band recombination process to be proportional to both the concentrations of electrons and of holes. Thus for an n-type semiconductor [7]

$$R = \alpha n_p p_n \tag{2}$$

Where

α : Proportionality constant

n_p : Concentration of electrons in an n-type semiconductor

p_n : Concentration of holes in an n-type semiconductor

Fig. 6 shows contours of recombination and photo-generation rate of electron-holes, due to the light intensity. Fig. (7.a) shows recombination rate versus depth across cutline 1 in Fig. (6.a).it can be seen that the recombination rate around the depth of 1μm is drastically decreased and in the depth of 2μm it nearly approaches zero. The situation is some different for photo-generation rate. Fig. (6.b) shows contour for photo-generation rate in PCSS. Fig. (7.b) shows photo-generation rate across the same cutline in Fig. (6.b). It is observed that although this rate decreases throughout the depth of device but it does not approach zero, it means that we had photo generation rate of electron-hole even through 5μm.

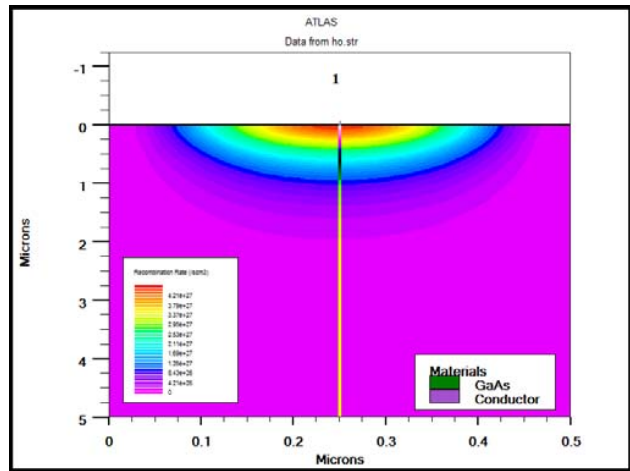

(6.a)

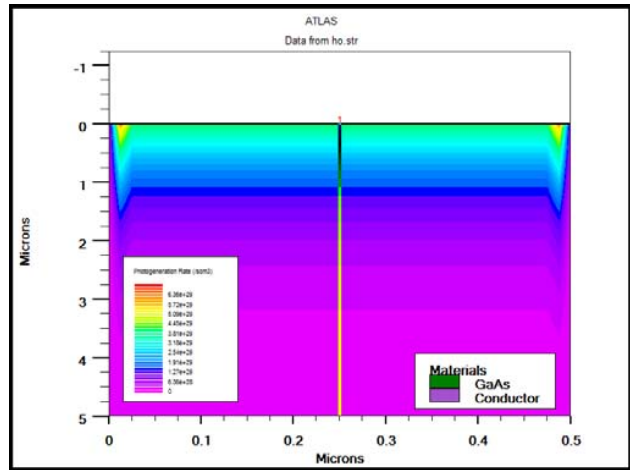

(6.b)

Fig. 6

(6.a) Recombination Rate Contour
(6.b) Photo Generation Rate Contour

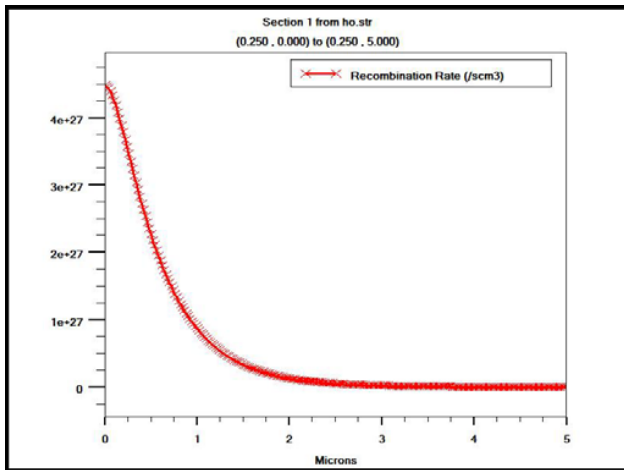

(7.a)

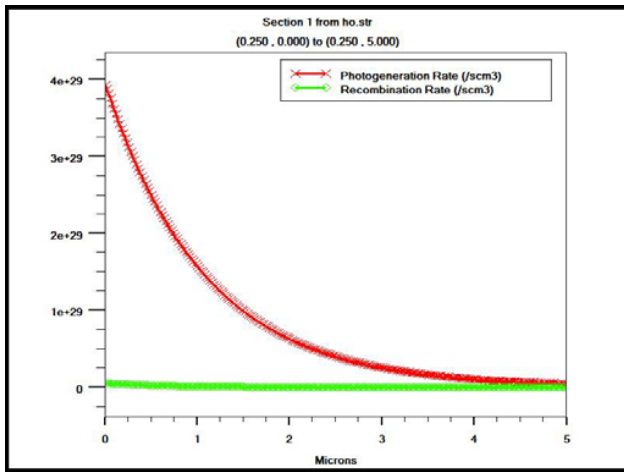

(7.b)

Fig. 7

(7.a) Recombination Rate outline throughout depth
 (7.b) Photogeneration compared with recombination

D. Current Density:

V_{dc} has a constant value of 10V and R_L is 50Ω constantly too, thus R_{on} plays a key role in determining the current amplitude.

I_{ON} is

$$I_{ON} = \frac{V_{DC}}{R_L + R_{ON}} \quad (3)$$

Where R_{ON} is given by [4]:

$$R_{ON} = \frac{LE_\lambda}{I_0 W (1-r) q \mu_T T_{net}} \quad (4)$$

Here:

- E_λ : the photon energy of the light
- r : the normal-incidence reflection coefficient of the light at the surface of the switch
- q : the electron charge

μ_T : the sum of the electron and hole mobilities
 $T_{net} \cong T_t$: average transit time of photo-generated carriers through the device

Although I_{ON} obtained regarding to formula (3) and was fit to the simulation analysis, but by analyzing the behavior of current density in switch we encounter to this issue that the contour of current density due to figure 8.a is not symmetric. Also investigating current vectors, we realized that current density vectors have an upward and right side (cathode) trends.(Fig. 8.b)

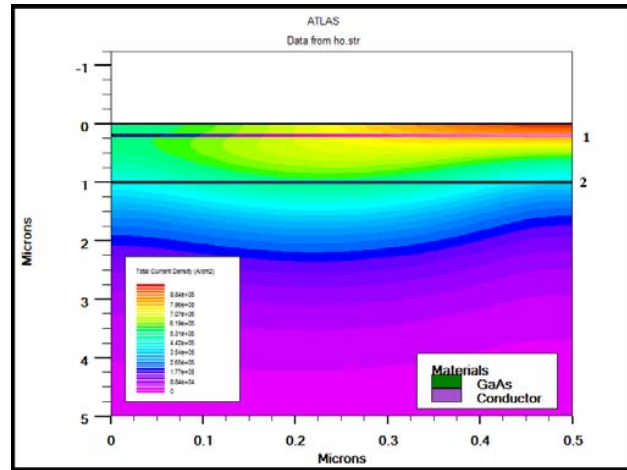

8.a

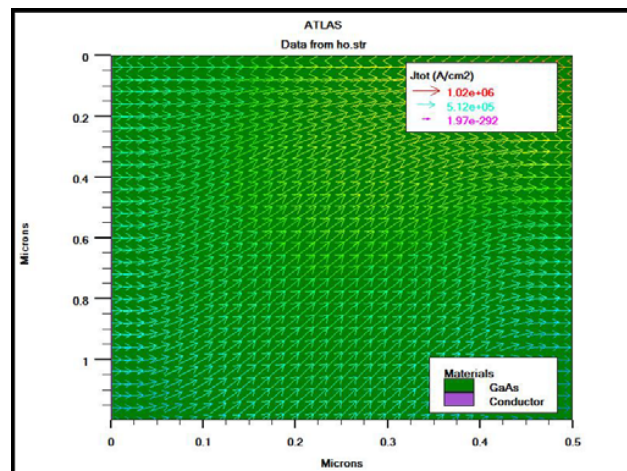

8.b

Fig. 8

(8.a) Total current density contour
 (8.b) Zoomed current density vectors

To illustrate this behavior we can mention in conjunction of Fig. 7. Deep in the device, generation rate approaches almost a constant value. However recombination approaches zero. Thus extra electrons and holes move towards anode and cathode respectively with different mobilities. Thus the asymmetry seen in Fig. 8 may be attributed to this effect.

Fig. 9.a and 9.b show the current density along cutline 1 and 2 in Fig 8.a respectively.

It is observed that current density varies drastically at cathode and while it is relatively constant to the end of anode.

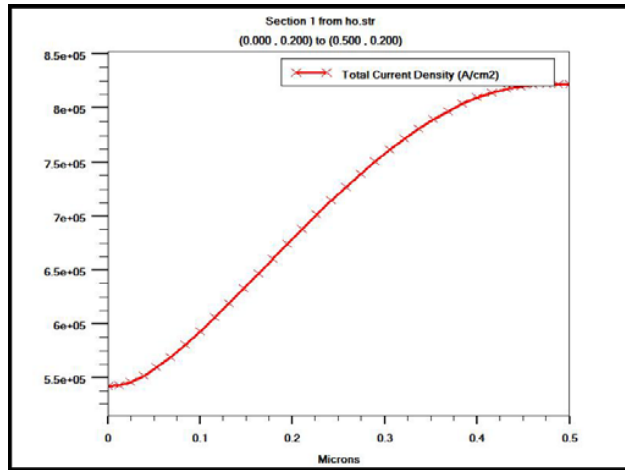

9.a

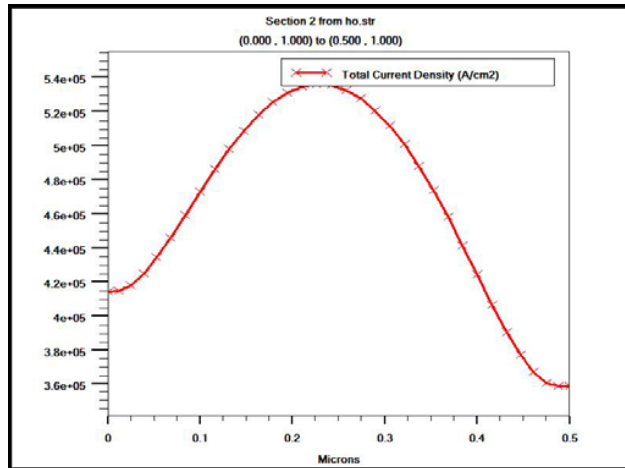

9.b

Fig. 9 amount of current density
(9.a) amount of current density in 0.2 μ m depth
(9.b) amount of current density in 1 μ m depth

V.CONCLUSION

A PCSS (Photoconductive Semiconductor Switch) operation was studied in the frequency band of 10 GHz it was shown that despite symmetric geometry, this switch has asymmetrical distribution of current density in the on-state steady state mode and concentration of current density in cathode side varies much more drastically. This may be the reason why fabrication of the cathode needs special attention as alluded to in several references. Using high doped region near electrodes and large areas for the switch may help this situation.

REFERENCES

- [1] Atlas User's Manual, Silvaco Int., Santa Clara, CA, Sep, 2004.
- [2] A. Karabegovic , R.M. O'Connell , and W.C. Nunnally, "Photoconductive Switch Design for Microwave Applications", IEEE Transactions on Dielectrics and Electrical Insulation vol.16,NO.4; 2009
- [3] R.M.O'Connell, C.J.Huany, A.Karabegovic, and W.C.Nunnally, "Optoelectronic microwave power amplifiers", IEEE Trans. Dielectr. Electr. Insul., vol.14,pp. 994-1001, 2007.
- [4] A.Karabegovic, R.M.O'Connell , and W.C.Nunnally , "Photoconductive Semiconductor Switch for microwave applications" , IEEE 28th Intern. Power modulator conf., Las vegas, NV, USA, PP.9-12,2008.
- [5] M. Fathipour, A. E. Ardakani, "Semiconductor Devices: an Introduction", Uni. of Tehran press, 2002.
- [6] I. M. Abolduyev, A. M. Zubkov, and V. M. Minnebaev, "X-Band Power amplifier for Active Phased-Array Antennas", ICSC'98,3rd Intern. Conf. on Satellite Communications , Vol 1, pp. 170-171, 1998
- [7] A. S. Grove , "Physics and Technology of Semiconductor Devices", John Wiley and Sons, Inc., New York.