

# The Effect of Carbon on Molybdenum in the Preparation of Microwave Induced Molybdenum Carbide

Abd. Rahim Yacob, Mohd Khairul Asyraf Amat Mustajab, and Nurshaira Haifa Suhaimi

**Abstract**—This study shows the effect of carbon towards molybdenum carbide alloy when exposed to Microwave. This technique is also known as Microwave Induced Alloying (MIA) for the preparation of molybdenum carbide. In this study ammonium heptamolybdate solution and carbon black powder were heterogeneously mixed and exposed to microwave irradiation for 2 minutes. The effect on amount of carbon towards the produced alloy on morphological and oxidation states changes during microwave is presented. In this experiment, it is expected carbon act as a reducing agent with the ratio 2:7 molybdenum to carbon as the optimum for the production of molybdenum carbide alloy. All the morphological transformations and changes in this experiment were followed and characterized using X-Ray Diffraction and FESEM.

**Keywords**—Carbon, molybdenum carbide, microwave induced alloying.

## I. INTRODUCTION

MICROWAVE is in the region between 300 GHz to 300MHz with wavelength from 1mm to 1 m in the electromagnetic spectrum. It has been widely applied for communication, while there is still present of microwave bands for other applications [1, 2]. For manufacturing, microwave irradiation has been an alternative route for the preparation of products, which uses less power and heating energy, fast reaction product, less sintering effect, improved physical and mechanical properties, yet simple and environmental friendly [3-7]. Thus, the microwave induced alloying was chosen for preparation of molybdenum carbide in this study.

Molybdenum carbide from Group IV transition metal fascinates industries for its properties for strength and wear resistance. This compound also proved to be good catalyst in heterogeneous gas-liquid reactions, thus a potential substitute to noble precious metals such as Ni, Pt and Rh. The present techniques for the preparation of molybdenum carbide include combustion, self-propagating high temperature synthesis, direct carburization, and field activated combustion. These

techniques, however, require high temperature of up to 2000°C and very specialized high temperature equipments, gadget and facilities [8-15]. The most common technique for the preparation of molybdenum carbide is the direct temperature-programmed reaction between Molybdenum Oxide with various sources of carbon. The disadvantage however was the blockage of the active sites that leads low surface area of the carbide. This is probably cause by contamination of polymeric carbon during alloying [11]. To overcome this problem, researchers are exploring for new techniques that can prepare alloy easier, faster, economically and added with high surface area, specifically for heterogeneous gas reactions. In this study, microwave alloying thus looks promising with advantages includes rapid synthesized, one-step process, and low temperature of reaction [15].

The use of activated carbon in this study offers added advantages of high surface area with good dispersed of the active sites and easy to control [16]. Thus, production of a suitable catalyst for most heterogeneous gases reaction will be achieved. Previous studied showed that the introduction of reducing agents in the preparation technique can caused the reducing of the alloying temperature. As an example, in the preparation of molybdenum carbide initially at 1800-2000°C was reduced significantly to 800 - 1200°C by the addition of KBH<sub>4</sub>, NaBH<sub>4</sub>, Mg, Zn, or mixtures of Mg and Zn [8] - [11], [17] - [22]. It was suggested that the reducing agents absorbed the oxygen from the molybdenum oxide, than the alloying process can took place. The corresponding oxidation state for Mo is initially +6 (MoO<sub>3</sub>), the will be reduced to +4 (MoO<sub>2</sub>) and 0 for atomic Mo or Mo<sub>2</sub>C alloy [23]. These stepwise transformations of oxidation states for molybdenum are shown by equation 1. This experiment however was carried in a pressure chamber with an optimum pressure of more than 1.5 MPa [19, 20];

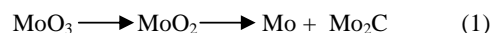

Subject to this topic, the goal of this study is in using microwave for the preparation of molybdenum carbide alloy. The highlight will be on the effect of carbon in the formation of microwave induced molybdenum carbide. The morphological and oxidation states changes during alloying will be characterized and to prove carbon acts as a reducing agent for the microwave reaction.

A.R. Yacob is with the Department of Chemistry, Faculty of Science, Universiti Teknologi Malaysia, Johor Bahru, Johor 81310 Mala. (phone: +607-5534505, fax: +607-5566162, email: manrahim@kimia.fs.utm.my)

M.K.A.A. Mustajab is with the Department of Chemistry, Faculty of Science, Universiti Teknologi Malaysia, Johor Bahru, Johor 81310 Mala (e-mail: krulchubby84@yahoo.com).

N.H. Suhaimi is with the Department of Chemistry, Faculty of Science, Universiti Teknologi Malaysia, Johor Bahru, Johor 81310 Mala (e-mail: shaafaa.hairaa@gmail.com).

## II. EXPERIMENTAL

### A. Review Stage

Molybdenum solution (1M) was prepared using ammonium heptamolybdate (AHM) by dissolving about 17.65 g of AHM with distilled water in a 100 ml volumetric flask. To prepare molybdenum carbide with 2:7 molar ratio, 0.5 g carbon was dispersed in 11.91 ml of the prepared AHM solution in a three-neck round bottom flask. Slow flow of nitrogen gas was allowed to the flask, to induce oxygen free environment. Microwave alloying was performed in the modified domestic microwave oven (Figure 1) for 2 minutes radiation time with power usage of 800 W. The product then washed using hot water and dried in oven at  $105 \pm 5^\circ\text{C}$ , left overnight.

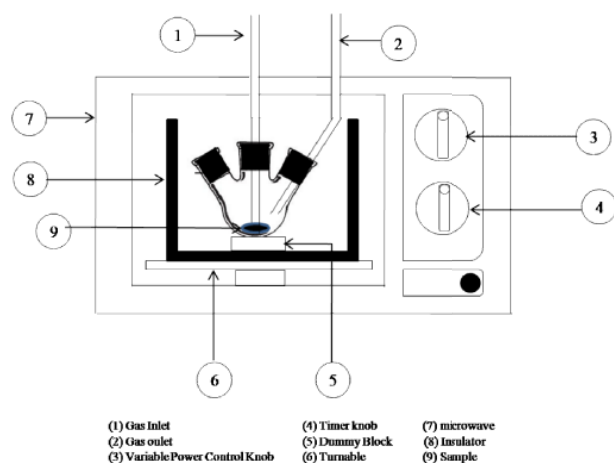

Fig. 1 The schematic diagram of modified microwave oven

### B. Characterizations

The characterization of the synthesized molybdenum carbides by MIA technique were carried out by X-ray Diffractogram Analysis and Field Emission Scanning Electron Micrograph. XRD examination was performed using Bruker X-ray powder diffractometer with  $\text{CuK}\alpha$  radiation source with  $\lambda = 0.15418$  nm at 40 kV and 40 mA. The  $2\theta$  range used was from  $10^\circ$  to  $90^\circ$  at a scanning speed of  $0.05^\circ$  per second. The identification of peaks is based on JCPDS-ICDD ( $\text{MoO}_3 = 35 - 609: 23.3^\circ, 25.7^\circ, 27.3^\circ, 39.0^\circ$ ,  $\text{MoO}_2 = 32 - 671: 26.0^\circ, 37.0^\circ, 53.5^\circ$ ,  $\beta\text{-Mo}_2\text{C} = 35 - 787: 34.4^\circ, 38.0^\circ, 39.4^\circ, 61.5^\circ, 69.6^\circ, 74.6^\circ$ ) database incorporated in the software. To estimate the appearance or disappearance of  $\text{MoO}_2$ ,  $\text{MoO}_3$  and the targeted product ( $\text{Mo}_2\text{C}$ ), peak analysis was carried out based on XRD diffractogram for each sample. Three specific peaks were chosen; which were  $23.5^\circ$  (110) for  $\text{MoO}_3$ ,  $25.9^\circ$  (011) for  $\text{MoO}_2$  and  $39.7^\circ$  (101) for  $\text{Mo}_2\text{C}$  respectively. FESEM micrograph was taken on JEOL JSM-6701F with energy of 15.0V couple with EDX. This analysis was done to study the size and shape of the samples or its surface morphology and elemental analysis.

## III. RESULTS AND DISCUSSIONS

### A. X-Ray Diffraction Analysis

This section explains the characterization and assignment of the synthesized molybdenum carbide and peaks analysis to identify the presence of each target molecules. Figure 2 and 3 show all the XRD diffractograms for the prepared samples

with the respective ratio carried in this study.

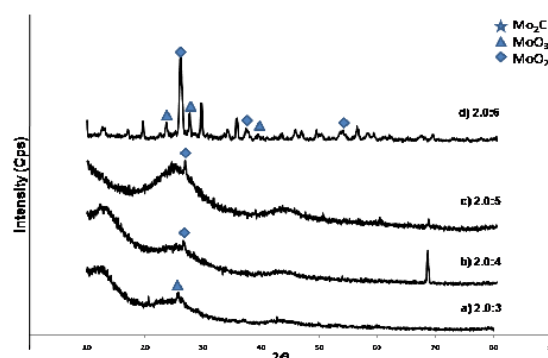

Fig. 2 The XRD diffractograms for synthesized ratio of a) 2:3, b) 2:4, c) 2:5, and d) 2:6 respectively

The lowest synthesized ratio of 2:3 (Figure 2) shows the presence of orthorhombic  $\text{MoO}_3$  species only. The ratio 2:4 and 2:5 then showed a new tetragonal  $\text{MoO}_2$  species starting to develop in the samples. By further increased of the carbon contents from 5 to 6 ratios, a different product is observed. High intensity peak at  $25.95^\circ$  with smaller peaks at  $37.15^\circ$  and  $53.15^\circ$  illustrate the presence  $\text{MoO}_2$ . This shows that slow increase of the carbon content, the  $\text{MoO}_3$  will be reduced or transformed to  $\text{MoO}_2$ . The present of low intensity peaks at  $23.45^\circ$ ,  $27.4^\circ$  and  $39.15^\circ$  at Figure 2(d), which belong to  $\text{MoO}_3$ , further confirm this finding.

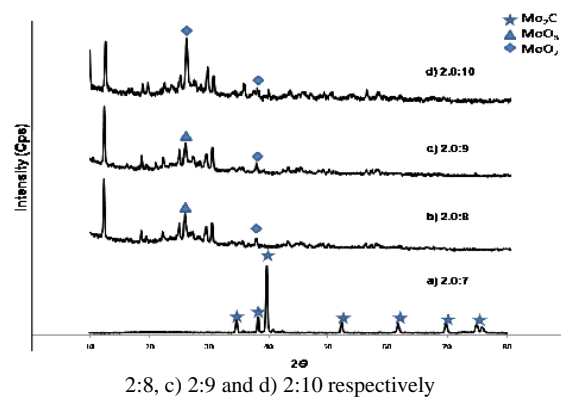
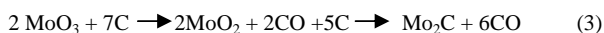
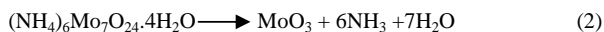

Figure 3, is the continuation diffractogram Figure 2, with increasing carbon content ratio. At stoichiometric ratio 2:7, all eight characteristic peaks, which belongs to hexagonal  $\text{Mo}_2\text{C}$  is observed. No other intermediates species were observed. At this ratio, it is proposed that carbon reduced Mo completely to zero, with the formation of molybdenum carbide  $\text{Mo}_2\text{C}$  alloy. This finding is similar to those found by Chaudhury *et al.*, [23]. Further increased of carbon content to 8, 9 and 10 respectively, resulted in the increase amount of  $\text{MoO}_2$  and  $\text{MoO}_3$  at the diffractogram. This demonstrates a shift to the reactant or left side of the reaction and the formation of respective oxides. Magnified observation showed that the

Mo<sub>2</sub>C peaks are still present in this XRD diffractograms, however in a minimal quantity. The back production of oxide is most probably from the AHM or impurities in carbon. No new oxygen is introduced since the set up is in oxygen deprived environment. Previous study by Yacob *et al.*, proposed the chemical equation as shown by equation 2 and 3 respectively [15];



To further understand the changes that happen during synthesis and microwave alloying, peaks analysis for each oxides and carbides were carried by selecting the characteristic peak for each molecule. The peak assignment were as follows: peak at 23.3° (110) was selected and assigned to orthorhombic MoO<sub>3</sub>, 25.9° (011) for tetragonal MoO<sub>2</sub> and 39.7° (101) for hexagonal Mo<sub>2</sub>C respectively. Figure 4, 5 and 6 show the representative bar charts for each respective peak analysis.

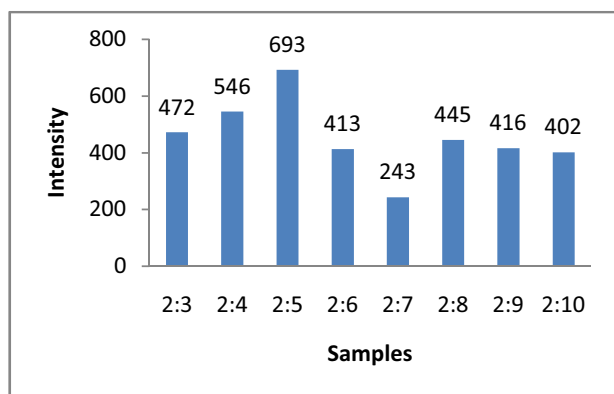

Fig. 4 Peak analysis at 23.3 ° for orthorhombic MoO<sub>3</sub>

Figure 4 showed the intensity peaks at 23.3 ° and was assigned to orthorhombic MoO<sub>3</sub> for all the alloyed ratios. Previous report stated that after exposed by microwave, ammonium heptamolybdate to transform to form molybdenum trioxide, before undergoing reduction to produce molybdenum dioxide and finally molybdenum carbide, referred to equation 2 [15]. This studied showed that MoO<sub>3</sub> was successfully synthesized in all of the samples; with ratio 2:5 recorded the highest peak. Ratio 2:7 however showed the lowest intensity of this peak in the analysis. This indicate that most probably all the MoO<sub>3</sub> synthesized had transformed to the next oxides i.e. MoO<sub>2</sub>. The most interesting part is the formation of MoO<sub>3</sub> increased in sequence at ratio 3 to 5 while at ratio 8 to 10, displayed almost constant intensity of peak achieved. This analysis proved that during microwave alloying, the first step of reaction is the formation of the trioxide (equation 2) and this is clearly observed in this experiment.

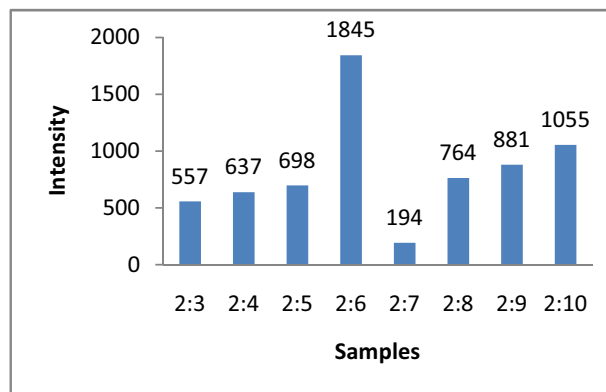

Fig. 5 Peak analysis at 25.9 ° for tetragonal MoO<sub>2</sub>

Figure 5 showed the intensity peak at 25.9 ° and was assigned to tetragonal MoO<sub>2</sub>. Based on this graph, the ratio 2:6 recorded the highest peak which indicate that a large number of MoO<sub>2</sub> molecules present in this sample. This analysis indicated with the addition of 1 ratio of carbon, transformation of MoO<sub>3</sub> to MoO<sub>2</sub> was successfully. The same phenomenon was deployed when addition of carbon at further ratios of 8, 9 and 10 respectively as these peaks were increased.

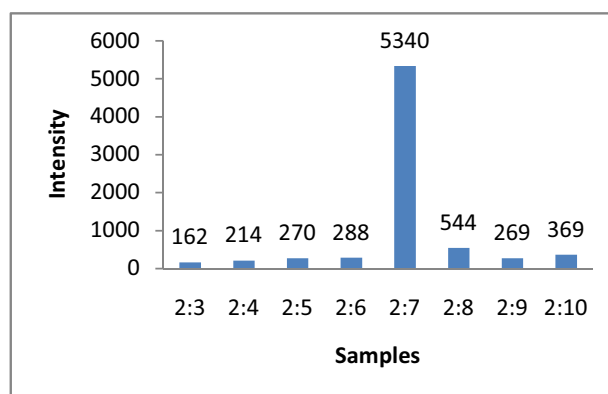

Fig. 6 Peak analysis at 39.7 ° for hexagonal Mo<sub>2</sub>C

Figure 6 showed the intensity peak at 39.7 ° which was assigned to hexagonal Mo<sub>2</sub>C for all the samples. The sample with ratio 2:7, after microwave alloyed, showed the most of the MoO<sub>2</sub> had transformed to Mo<sub>2</sub>C. This experiment further supported and proved that by using Microwave Induce Alloying, the carbides was synthesized by the reduction of molybdenum oxides, with the routes suggested by equation 2 and 3 respectively. Excess of carbon in this experiment however does not help in obtaining more carbide but had initiated the back reactions to the oxides formation. This is most probably due to the limited irradiation energy hitting the reactants or might be shielded by the excess carbon added. The preparation of molybdenum carbide in this experiment showed that optimization only happened at a specific ratio. This observation and characterization was similar to our literature review and further confirmed their finding [19]. In addition, at Fig. 4 and Fig. 5, peak analysis for ratio 2:7

demonstrated lowest amount of  $\text{MoO}_2$  and  $\text{MoO}_3$ , vice versa to result from the peak analysis of  $\text{Mo}_2\text{C}$ . This observable fact proved that the optimum ratio to prepare molybdenum carbide in this experiment was 2:7.

### B. FESEM-EDX

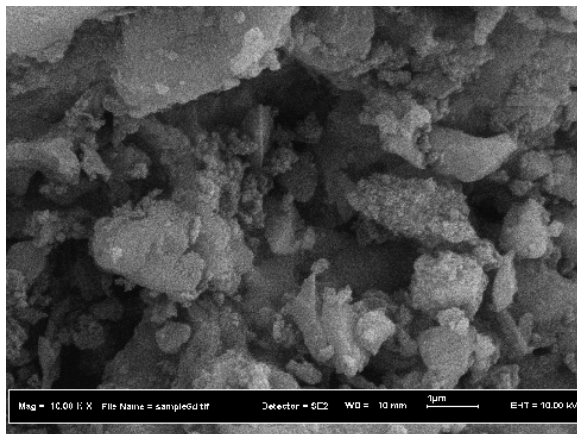

Fig. 7 FESEM micrograph of sample 2:7

The structural morphology of the prepared molybdenum carbide with ratio 2:7 was recorded using FESEM and shown by Figure 7. The prepared molybdenum carbide was solely in the form of agglomerated particles with 0.01 to 0.1  $\mu\text{m}$  in size. EDX results on the other hand revealed that the percentage composition of oxygen, molybdenum and carbon which were 8.91%, 7.89% and 82.65% respectively.

### IV. CONCLUSION

This work demonstrated that the formation of molybdenum carbide via microwave techniques is possible and achievable using ammonium heptamolybdate as the molybdenum source and activated carbon. This technique further proved that the transformation routes are from the trioxide, to dioxides and finally to its carbide alloy is possible. The XRD diffractograms further support and display the morphological transformation and reduction that took place during the microwave alloying.

### ACKNOWLEDGMENT

The authors would like to thank the Universiti Teknologi Malaysia and Malaysian Ministry of Science, Technology and Innovation for their financial funding through National Science Fellowship.

### REFERENCES

- [1] D. Bogdal and A. Prociak. *Microwave-Enhanced Polymer Chemistry and Technology*. Oxford, UK: Blackwell Publishing, 2007.
- [2] M. Oghbaei and O. Mirzaee, "Microwave Versus Conventional Sintering: A review of Fundamentals, Advantages and Applications," *Journal of Alloys and Compounds*, vol. 494 (1-2), 2010, pp. 175 – 189.
- [3] P. Yadoji, R. Peelamedu, D. Agrawal and R. Roy, "Microwave sintering of Ni-Zn ferrites: comparison with conventional sintering," *Material Science and Engineering B*, vol. 98(3), 2003, pp. 269 – 278.
- [4] D. Agrawal, "Microwave Sintering of Ceramics, Composite, Metals, And Transparent Materials," *Journal of Material Education*, vol. 19(4-6), 1999, pp. 49 – 58.
- [5] D.E. Clark, D.C Folz and J.K West, "Processing materials with microwave energy," *Material Science and Engineering A*, vol. 287(2), 2000, pp. 153 – 158.
- [6] C. Leonelli, P. Veronesi, L. Denti, A. Gatto and L. Juliano, "Microwave assisted sintering of green metal parts," *Journal of Material Process and Technology*, vol. 205(1-3), 2008, pp. 489 – 496.
- [7] R.R. Menezes, P.M. Souto and R.H.G.A Kiminami, "Microwave hybrid fast sintering of porcelain bodies," *Journal of Material Process and Technology*, vol. 190 (1-3), 2007, pp. 223 – 229.
- [8] M. Saito and R.B. Anderson, "The activity of several molybdenum compounds for methanation of  $\text{CO}$ ," *Journal of Catalyst*, vol. 63 (2), 1980, pp. 438 – 446.
- [9] L. Volpe and M. Boudart, "Compounds of molybdenum and tungsten with high specific surface area: Carbides," *Journal of Solid State Chemistry*, vol.59 (3), 1985, pp. 348 – 356.
- [10] T.C. Xiao, A.P.E. York, H. Al-Megren, A. Hanif, X.Y. Zhou and M.L.H. Green, "Preparation and characterisation of bimetallic cobalt and molybdenum carbides," *Journal of Catalyst*, vol. 202, 2001, pp. 100 – 109.
- [11] Q. Zhu, Q. Chen, X. Yang and D. Ke, "A new method for synthesis of molybdenum carbide," *Material Letter*, vol. 61, 2007, pp. 5173 – 5174.
- [12] K.S. Suslick, M. Fang and T. Hyeon, "Nanostructured molybdenum carbide: sonochemical synthesis and catalytic properties," *Journal American Chemical Society*, vol. 118, 1996, pp. 5492 – 5493.
- [13] S. Li, J.S. Lee, T. Hyeon and K.S. Suslick, "Catalytic hydrogenation of indole over molybdenum nitride and carbides with different structures," *Applied Catalyst A: General*, vol. 184, 1999, pp. 1 – 9.
- [14] C. Liang, M. Piang, C. Li, L. Ding, J. Zhang, D. Su and W. Li, "Microwave-assisted preparation of  $\text{Mo}_2\text{C}/\text{CNTs}$  nanocomposites as efficient electrocatalyst supports for oxygen reduction reaction," *Industrial and Engineering Chemistry Research*, vol. 49, 2010, pp. 169 – 174.
- [15] A.R. Yacob and M.K.A.A Mustajab, "Preparation of molybdenum carbide via Microwave Induced Alloying," *Jurnal Teknologi (Sains & Kej)*, vol. 57(1), 2012, pp. 155 – 162.
- [16] C. Liang, P. Ying, and C. Li, "Nanostructured  $\beta\text{-Mo}_2\text{C}$  prepared by carbothermal hydrogen reduction on ultrahigh surface area carbon material," *Chemistry of Materials*, vol. 14, 2002, pp. 3148 – 3151.
- [17] Y. Li, G. Luo, Y. Fan and Y. Chen, "A novel route to the synthesis of nanosized metallic molybdenum at moderate temperature and its catalytic properties," *Material Research Bulletin* vol.39, 2004, pp. 195 – 203.
- [18] H.H. Nersisyan, J.H. Lee and C.W. Won, "The synthesis of nanostructured molybdenum under self-propagating high temperature synthesis mode," *Material Chemistry and Physics*, vol. 394, 2005, pp. 283 – 288.
- [19] K. Manukyan, D.H. Davtyan, J. Bossert and S.L. Kharatyan, "Direct reduction of ammonium molybdate to elemental molybdenum by combustion reaction," *Chemical Engineering Journal*, vol.168, 2011, pp. 925 – 930
- [20] K. Manukyan, S. Aydinyan, A. Aghajanyan, Y. Grigoryan, O. Niazyan and S. Kharatyan, "Reaction pathway in the  $\text{MoO}_3 + \text{Mg} + \text{C}$  reactive mixtures," *International Journal Refractory Metal and Hard Material*, vol. 31, 2012, pp. 28 – 32.
- [21] D. Davtyan, K. Manukyan, R. Mnatsakanyan and S. Kharatyan, "Reduction of  $\text{MoO}_3$  by Zn: reducer migration phenomena," *International Journal Refractory Metal and Hard Material*, vol. 28(5), 2010, pp. 601 – 604.
- [22] S.V. Aydinyan, Z. Gumruyan, K. Manukyan and S.L. Kharatyan, "Self-sustaining reduction of  $\text{MoO}_3$  by the Mg-C mixture," *Material Science and Engineering B*, vol. 172, 2010, pp. 267 – 271..
- [23] S. Chaudhury, S.K Mukerjee, V.N Vaidya and V. Venugopal, "Kinetics and mechanism of carbothermic reduction of  $\text{MoO}_3$  to  $\text{Mo}_2\text{C}$ ," *Journal of Alloys and Compounds*, vol. 261, 1997, pp. 105 – 113.