

Rapid Determination of Biochemical Oxygen Demand

Mayur Milan Kale and Indu Mehrotra

Abstract—Biochemical Oxygen Demand (BOD) is a measure of the oxygen used in bacteria mediated oxidation of organic substances in water and wastewater. Theoretically an infinite time is required for complete biochemical oxidation of organic matter, but the measurement is made over 5-days at 20 °C or 3-days at 27 °C test period with or without dilution. Researchers have worked to further reduce the time of measurement.

The objective of this paper is to review advancement made in BOD measurement primarily to minimize the time and negate the measurement difficulties. Survey of literature review in four such techniques namely BOD-BART™, Biosensors, Ferricyanide-mediated approach, luminous bacterial immobilized chip method. Basic principle, method of determination, data validation and their advantage and disadvantages have been incorporated of each of the methods.

In the BOD-BART™ method the time lag is calculated for the system to change from oxidative to reductive state. BIOSENSORS are the biological sensing element with a transducer which produces a signal proportional to the analyte concentration. Microbial species has its metabolic deficiencies. Co-immobilization of bacteria using sol-gel biosensor increases the range of substrate. In ferricyanide-mediated approach, ferricyanide has been used as e-acceptor instead of oxygen. In Luminous bacterial cells-immobilized chip method, bacterial bioluminescence which is caused by *lux* genes was observed. Physiological responses is measured and correlated to BOD due to reduction or emission.

There is a scope to further probe into the rapid estimation of BOD.

Keywords—BOD, Four methods, Rapid estimation

I. INTRODUCTION

THE Royal Commission on Sewage Disposal (1898) led to the selection in 1908 of BOD₅ as the definitive test for organic pollution of rivers. Phelps studied kinetics of degradation of organics in water [1], Logan, suggested headspace biochemical oxygen demand [2], Booki investigated the use of fiber optic probe to obtain oxygen demands; respirometric tests [3]. Kinetics of BOD reactions have established that they are for most practical purpose “first order” in character, or the rate of reaction k' , is proportional to the amount of biodegradable matter; concentration C remaining at any time t , as modified by the population of active organisms as in (1).

$$-(dC/dt) = k'C \quad (1)$$

BOD exertion involves catabolism where complex substrates are enzymatically degraded into simpler molecules, providing the cell with organic carbon and energy in the form

of adenosine triphosphate (ATP)(2). The process of formation of new cell is known as anabolism (3).

Catabolism



Anabolism



Bacterial exertion takes place when bacteria are in active phase. Five stages of bacterial growth namely Lag Phase, Exponential Growth-Phase, Stationary Phase, Death Phase, Endogenous Phase prevail in a batch reactor.

To alter any method the factors affecting that process is very important. They are follows:

- Concentration and nature of substrate available,
- Micro-Organisms existing,
- Electron Acceptor,
- Nutrients,
- Temperature,
- pH,
- Total Dissolved Solid,
- Inhibition and Toxicity.

The L_0 and k' values: depends on two factors (a) the nature of the organic matter and (b) the ability of the organisms present to utilize the organic matter.

II. BOD MEASUREMENT

A. Standard Methods [3]

As of now BOD of water and waste water samples are measured by dilution or without dilution or by respirometric method.

B. Advances in BOD Determination

An infinite time is required for complete biological oxidation of organic matter. For practical purpose a 20 days time may be considered for determination of BOD. A need was felt to reduce the time of BOD measurement. It was achieved by measuring BOD (3day- 27°C) instead of BOD (5day- 25°C).

Researchers have worked to further reduce the time of measurement. This report summarizes some of the studies carries out for rapid determination of BOD.

C. Rapid Determination Methods

1) Bod-Bart™

Biological Activity Reaction Tests (BART) was developed and patented by Cullimore and Alford [4]. BOD-BART™

Mayur Milan Kale M.Tech, Final Yr. Student Indian Institute of Technology, Roorkee. (Ph.no.:09917720969; mkale.stu@gmail.com);

Dr. Indu Mehrotra Professor, Department of Civil Engg., Indian Institute of Technology, Roorkee. (indumfce@iitr.ernet.in)

system provides an easy and rapid (<20-hour or <72,000 seconds) measurement of the BOD based on enhanced respiration activity of the indigenous heterotrophic aerobic bacteria (HAB) inhabiting the sample. Johnston studied this system with municipal wastewater [5].

Basic Principle: To undertake a BOD test using the BART™ format, the rate of oxygen consumption in the water sample itself is measured within a BOD-BART™ test. The rate of dissolved oxygen consumption can be valuated by determining the time for the initiation of a change in the redox state of the sample (from oxidative to reductive state). The time lag over which this occurs lengthens with decreasing BOD concentration in the water/wastewater samples [4,5]. Accurate determination of the respiration rate of intrinsic population of HAB (i.e. the rate of the free oxygen uptake) in terms of time to positive reaction or time lag (TL) is the essence of the rapid determination of BOD-BART. This is used to determine the concentration of biodegradable organic matter present within the sample that could create the oxygen demand. HAB are able to biodegrade or consume organic matter in water bodies as their source of energy using the available oxygen as an electron acceptor.

Apparatus: BOD-BART tester™ is the trademark applied to the patented concepts employed in the BART test apparatus that allows a 15ml sample of effluent to be used and a time lag obtained that can be related directly to the BOD of that sample.

BOD-BART reader™ is an electronic device that allows the detection of the time lags for up to six BOD-BART testers. The positive results are displayed on-screen in seconds that may be converted from a standard table to BOD. The reader operates on 120 volts AC. To improve precision the reader incorporates an incubator that maintains the testers at 24°C.

BOD-BART read™ is the software package written in Visual Basic™ that allows the information to be managed.

BOD-BART isothermal incubator block is a block in which the reader is kept. It should be set at 28±1.0 C.

Procedure: The summary of set-up procedure used for testing waste water sample from an aerated lagoon in a municipal wastewater treatment plant is as follows:

1) Using a 10 or 20ml pipette fill the BOD-BART tester with 15ml of the sample to be tested. The fluid level should now have reached the fill line set at 15ml.

2) Turn the tester upside down on a clean dry flat surface for 30 seconds allowing methylene blue to dissolve into the wastewater sample.

3) The testing continues for up to 24 hours (86,400 seconds) with the testers being incubated by the isothermal block at 28±1.0°C. This testing consists of routinely determining the sorption of a red light being pulsed at two positions through the tester. Initially these pulses of red light are absorbed by the methylene blue but once reductive conditions are generated by microbial respiration then the methylene blue moves into a reductive state and light passes through the tester as shown in Fig. 1(a) The time lag to this event becomes the BOD-BART.

Data Validation: Four different types of samples were used. These included: primary influent (raw municipal wastewater), primary effluent (after primary settling), tertiary influent (after secondary biological treatment), and tertiary effluent (final treated wastewater to be discharged into the creek. Regression

analyses were conducted to develop the nature of the relationship (based on best-fit line/curve) between the time lag obtained from BOD-BART™ analysis and the comparable standard BOD₅ test result as shown in Table I, to consider the importance of other potentially impacting factors (dilution effect, color, temperature, oxygen saturation, mixing etc.) and also fluctuations in the characteristics of the municipal wastewater. Fig.1(b). shows the relationship between the time lag in hours and BOD₅ (up to 350 mg/L). An estimated scale based on the theoretical milligrams per liter of oxygen demand that has been assessed for each specific sample is obtained. BOD-BART will be given as the number of seconds generated by the time delay to the point when each sample tested was found to have gone reductive by DO reaction. Table I is generated for direct comparison and an equation which would be relevant to effluent samples from secondary and tertiary treatment processes can be estimated.

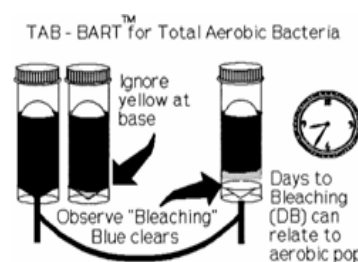

Fig. 1(a). Methylene blue reduction to a colorless [4]

Limitations

- The BOD-BART system is restricted in its claims to the examination of the secondary and tertiary effluents generated by either the aerated lagoon or the activated sludge process when it is applied to municipal waste waters only.
- The acceptable range within which the BOD-BART reader generated precision in suitable treated influents and effluents is from 60 down to 8 mg/L.
- TL for the BOD-BART to detect the range of BOD₅ can be function over a range of 20,000 to 60,000 seconds with an inverted correlation. The TL goes up as the BOD₅ declines.
- Undertaking a set-up sequence involving more than one sample and the subsequent replicates can cause errors to be generated in the BOD-BART data generated. This is due to the fact that the test begins as soon as the tester has been inverted and agitated to saturate the sample with

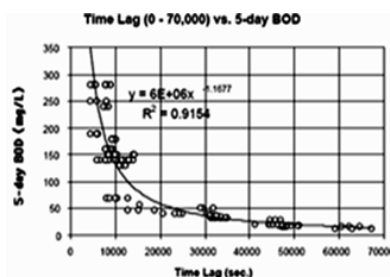

Fig. 1 (b). TL (hrs) Vs. BOD₅ (y axis up to 350 mg/L)[5]

headspace oxygen. Delay of even two minutes may cause the final BOD-BART to vary by 120 seconds.

TABLE I
SUMMARY OF BOD COMPARISON [5]

Sample	No. of Triplicate Samples	Range of BOD ₅ (mg/L)	Range of BOD _{max} (seconds)
Primary Influent (PI)	8	190 - 280	4,400 - 8,800
Primary Effluent (PE)	19	70 - 180	5,700 - 12,900
Lagoon 1s (1s)	2	50 - 57	15,300 - 32,800
Lagoon 2a (2a)	2	46 - 70	7,800 - 18,600
Lagoon 3 (3)	3	28 - 41	20,500 - 44,400
Secondary Effluent (SE)	7	32 - 36	31,100 - 34,900
Tertiary Effluent (TE)	8	17 - 21	44,200 - 50,900
Creek - WAO	1	17	60,400 - 64,600
Creek - Lumsden	1	13	58,900 - 67,100
Total Range	51	13 - 280	4,300 - 67,100

2) Biosensors

Biosensors are devices that transduces a selective biochemical response to a measurable signal. Karube published the first report of BOD biosensor [6]. Design and development of a BOD sensor, based on a pre-tested formulated, synergistic microorganism in combination with an oxygen electrode is done. Rastogi researched about the response of BOD sensor to various industrial samples [7].

Basic Principle: The signal produced can result from a change in protons concentration, release or uptake of gases, light emission, absorption and so forth, brought about by the metabolism of the target compound by the biological recognition element. Microorganisms have been integrated with a variety of transducers such as amperometric, potentiometric, calorimetric, conductimetric, colorimetric, luminescence and fluorescence to construct biosensor devices. A summary of different biosensors developed is given in Table II.

Material: A formulated, synergistic and pre-tested microbial consortium system as shown in Fig. 2(a), was used as a reference seeding material for BOD analysis & was incorporated as the bio-component in the developed BOD sensor [6].

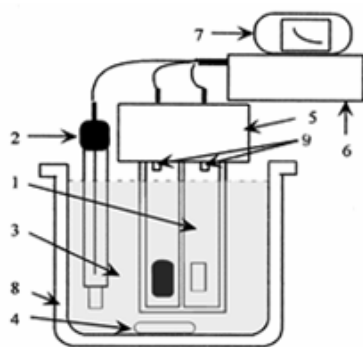

Fig. 2(a) Schematic diagram of the BOD measuring system [6]
(1) BOD sensor tip; (2) reference electrode; (3) sample solution containing buffer and mediator; (4) magnetic stirring bar; (5) connector; (6) mutimeter; (7) recorder; (8) thermostated water-jacket vessel; (9) electrical contacts.

TABLE II
SUMMARY OF HISTORY OF BIOSENSORS[6-12]

Sr. No	Title, Author &Year	Sample tested /Application	Remarks
1	Microbial Biosensors Karube <i>et. al.</i> (1977) <i>T. cutaneum</i>	Industrial effluents	Collagen membrane and an oxygen probe is used.
2	Amperometric Estimation Of BOD By Using Living Immobilized Yeasts Hikuma <i>et. al.</i> (1979) <i>Trichosporon cutaneum</i>	Untreated waste waters from a fermentation factory	1)The response time was within 18 min. 2)Porous membrane and an oxygen electrode 3)Current output of the microbial electrode sensor was almost constant for 17 d and 400 tests.
3	A BOD Sensor Using Klebsiella Oxytoca As1 Ohki <i>., et. al.</i> (1994) <i>Trichosporon cutaneum</i> & <i>K. oxytoca</i>	Industrial effluents	1)1 hr response of <i>K. oxytoca</i> sensor 2) <i>K. oxytoca</i> sensor showed a higher resistance to some toxic substances, such as phenol, compared to <i>T. cutaneum</i> sensor.
4	On-Line Biochemical Oxygen Demand Analyser Jung <i>et. al.</i> (1995) Calcium alginate entrapped activated sludge microorganisms	Activated sludge from a wastewater treatment plant	1)BOD of a wastewater stream can be computed in 5-10 h with a 98% accuracy 2) Microbes have to be pre-acclimated to the wastewater stream being monitored.
5	Immobilised Activated Sludge Based Biosensor For Biochemical Oxygen Demand Measurement Sangeetha, <i>et. al.</i> (1999) <i>Trichosporon cutaneum</i>	OECD synthetic wastewater	1)Dissolved oxygen electrode 2) Reproducibility of responses using one sensor was below $\pm 5.6\%$ standard deviation.
6	BOD Analysis of Industrial Effluents: 5 Days To 5 Min Rastogi <i>et. al.</i> (2002) <i>Citrobacter klebsiella</i> ,	Dairy, distillery and tannery industries.	1)Immobilized bacteria could show different respiration rates even although the samples have the same BOD ₅ values. Response time 5-10 min
7	Co-immobilized Microbial Biosensor For BOD Estimation Based On Sol-Gel Derived Composite Material Jianbo <i>et. al.</i> (2002) <i>T. cutaneum</i> and <i>B. subtilis</i>	Glucose	1)Strain of yeast and a strain of bacterium were coimmobilized to fabricate a BOD biosensor based on sol gel derived composite materials. Response time 40 min

Technique: The response of the electrode was measured in term of current (nA) obtained on a multimeter. In a few minutes after immersing the electrode assembly into a buffer solution, the current becomes constant because the diffusion rate of oxygen into the microbial film from the bulk of the solution reaches equilibrium with the consumption rate of oxygen by endogenous respiration of the immobilized microbes. This current level is named as initial basal current.

Then, in few minutes, the current of the dissolved oxygen (DO) probe reached another constant current level known as

the final basal current. The difference between the initial and final basal current values was defined as change in current (DI). The magnitude of the DI is proportional to a concentration of immediately biodegradable organic compounds in a sample. In a certain range, an unknown BOD concentration in a sample is predictable based on the magnitude of DI observed.

Data Validation: The findings are depicted in Table III. Response time 5–10 min. A linear relationship was observed between the current difference (between initial steady state and final steady state current) and the 5-day BOD of the standard solution GGA, Fig. 2(b).

Limitation

- The immobilized bacteria might assimilate various organic substances in distinct metabolic pathways or procedures, resulting in different levels of oxygen consumption.
- The immobilized bacteria could show different respiration rates even though the wastewater samples have the same BOD₅ values.

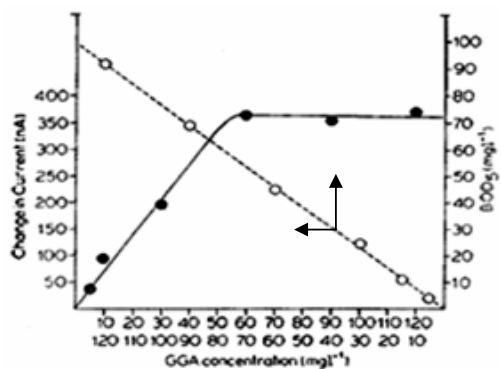

Fig.2(b) Calibration curve :BOD_{sensor} with conventional BOD₅. [7]

TABLE III
COMPARISONS OF BOD₅ VIS-A-VIS BOD(SENSOR). [7]

Sample	COD (mg/l)	BOD ₅ (mg/l)	BOD sensor	
			% Sample	BOD value (mg/l)
Mother dairy (inlet)	2750	1670	0.1	1600
			1.0	1070
			0.1	1600
			1.0	1070
Mother dairy (outlet)	650	320	2.0	400
			3.0	320
			2.0	400
			3.0	320
Distillery (inlet)	90,800	30,000	0.05	30000
			0.1	32000
			0.5	32000
			1.0	31000
Tannery (outlet)	575	50	2.5	60
			5.0	90
			10.0	50
			25.0	32
Tannery (inlet)	3440	1000	0.5	1400
			0.65	1350
			1	1800

3) Sol-Gel Biosensor

Dong developed Sol-Gel biosensor technique [13]. BOD

biosensors require microorganisms of low selectivity and high biooxidation activity for a wide range of organics. As each microbial species has its metabolic deficiencies, the universality of BOD sensor is often limited. Therefore, the mixed strain immobilized within a single membrane onto one sensor chip was developed.

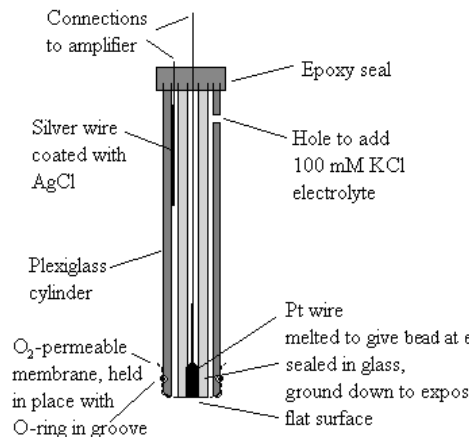

Fig. 3 Clark O₂-sensitive electrode

The use of a sol-gel derived composite material based on silica sol and PVA-g-P(4-VP) copolymer as a matrix for the enzyme immobilization is carried out. Sol-gel is used to immobilize a strain of yeast, *T. cutaneum* and a strain of bacterium, *B. subtilis*.

Technique: Silica sol was prepared as described by Dong. A selected amount of microorganisms was mixed adequately with 200 mL grafting copolymer PVA-g-P(4-VP) and 100 ml

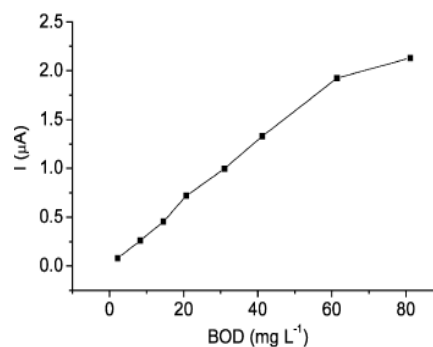

Fig. 4 Response time to calibrate the sensor for BOD measurement [12].

silica sol. Then 80 ml of the mixture was dropped on the teflon membrane. The membranes were dried at 4°C for 24 h and stored at 4°C before use. A Clark-type probe(oxygen sensor shown in Fig. 3 for dissolved oxygen was used as the physical transducer, which consisted of a platinum cathode as the working electrode, a silver anode as the reference electrode, and 0.1 mol/l potassium chloride (KCl) as supporting electrolyte [13]. The Teflon side of the membrane was attached to the cathode of the oxygen probe by means of a rubber O-ring. The electrolyte was filled in the space between the biomembrane and those two electrodes. The response time

of the sensor to different BOD solutions is different. The time taken for the current response to reach a constant value increases from about 3 min for BOD/5.0 mg/l to about 10 min for BOD 60.0 mg/l. A calibration curve is established for the BOD sensor using SRM (Standard Reference Materials for Environment BOD₅ (SRM BOD₅, 3200120) was purchased from Institute of Reference Materials, State Environmental Protection Administration, China.) BOD₅ as standard solutions. From Fig. 4, a linear relationship was observed from 1.0 to 60.0 mg/l BOD. The minimum detectable BOD is around 0.5 mg/l. Effects of various attributes on current is shown in Fig.5. Table IV. shows the comparison of SBOD and conventional BOD.

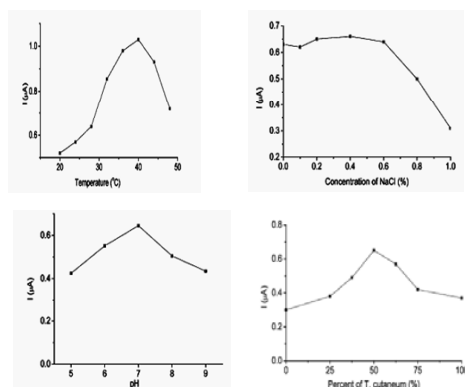

Fig. 5 Effects of temperature, inhibitor, pH, amount of microorganisms on current response.[12]

TABLE IV
COMPARISON OF SBOD AND BOD₅. [12]

Solution	SBOD (mg l ⁻¹)	BOD ₅ (mg l ⁻¹)	Ratio (SBOD/BOD ₅)
GGA ^a	225	220	1.023
OECD ^b	16100	17400	0.925
GGA+OECD	123	118.5	1.038
Domestic wastewater	6.4	6.6	0.970
Lake water	2.2	2.0	1.10

Limitations

- The choice of calibration solution and its composition have a dramatic influence on the quality of measurement.
- For broader substrate range, more microbes must be collectively immobilized.

The BOD sensor was used to determine the BOD values of OECD (Organization for Economic Cooperation and Development) synthetic wastewater domestic wastewaters, and lake waters. As shown in Table IV, the values obtained by the sensor agreed reasonably well with the results obtained by the conventional 5-day method.

4) Ferricyanide-An Electron Acceptor

Kylie used ferricyanide-mediated rapid BOD approach to overcome the oxygen limitation problems [14]. In this case, O₂ was replaced by the ferricyanide ion as shown in (4), which served as an alternative electron acceptor in the biochemical reaction. The advantage of using an alternative electron acceptor such as ferricyanide is its high solubility compared to oxygen. This allows the use of much higher microbial

populations without rapid depletion of the electron acceptor. As a result, the long incubation times required to microbially oxidize significant amounts of organic substrate are greatly decreased.

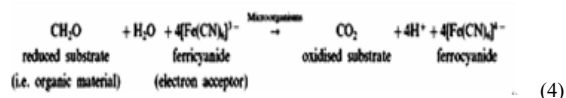

The microorganisms used were *Pseudomonas putida*, *Bacillus licheniformis* and *Trichosporon cutaneum*. All are known to have broad-range substrate. *E. coli* was also included for comparison purposes. The glucose-glutamic acid (GGA) standard BOD solution was used as a calibration standard for this work. In all cases, the ferricyanide-mediated microbial reactions were monitored using amperometry at a platinum microelectrode to determine ferrocyanide concentration. Chronoamperometric response obtained after a 1-h incubation of *T. Cutaneum* in a glucose solution containing ferricyanide was observed [14]. The magnitude of the current is a measure of the extent of microbial oxidation of the glucose solution in 1 hour. The analytical signal shown in Fig 6 for the BOD of the glucose solution was represented by the difference between the limiting current obtained for the glucose sample and the limiting current obtained for the endogenous control (i.e.No-glucose). The magnitude of the diffusion limiting currents for the responses can be quantitatively related to the concentration of microbially produced ferrocyanide via the relationship (5) where i_{lim} is the experimentally measured diffusion limiting current, n is the number of electrons transferred per mol of electroactive species ($n=1$ in this case), F is the Faraday constant, D is the diffusion coefficient ($7.96 \times 10^{-6} \text{ cm}^2 \text{ s}^{-1}$), r is the radius of the disk electrode and C is the concentration of the electroactive species.

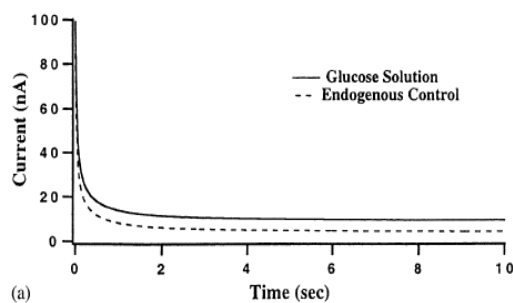

Fig. 6 Chronoamperograms of 10- μm Pt microelectrode , 1-h incubation of [14]

$$i_{\text{lim}} = 4nFDrC \quad (5)$$

The extent of glucose degradation in 1 h was calculated to be 55.1% for *T. Cutaneum* compare favorably with the conventional, aerobic, BOD₅ assay in which approximately 60% is utilized in 5 days. 30.4 & 62.8 % for *B. Licheniformis* and for *P. Putida* also show promising results.

Data Validation: To predict BOD₅ values of a variety of organic substances microorganisms were incubated (in the presence of ferricyanide) in standard solutions of glucose, sucrose, glutamic acid and glycine as shown in Table 5. Each organic solution was prepared at concentrations equivalent to

BOD₅ values of 200 mg /l. The limiting current values for extended incubation were also measured (Fig. 7).

TABLE V
FERRICYANIDE-MEDIATED EQUIVALENT BOD₅ VALUES FOR STANDARD SUBSTRATE SOLUTIONS [14]

Solution	BOD ₅ value (mg BOD ₅ l ⁻¹)	Ferricyanide-mediated BOD ₅ values (mg BOD ₅ l ⁻¹)			
		<i>E. coli</i>	<i>B. licheniformis</i>	<i>T. citanorum</i>	<i>P. putida</i>
Glucose/glutamic acid	198 ± 30 ^a	198 ± 19 ^a	198 ± 9 ^a	198 ± 4 ^a	198 ± 12 ^a
Glucose (330 mg l ⁻¹)	200 ± 24 ^a	362 ± 45	210 ± 2	189 ± 17	228 ± 14
Glutamic acid (344 mg l ⁻¹)	200 ± 24 ^a	120 ± 6	72 ± 4	67 ± 6	139 ± 25
Sucrose (320 mg l ⁻¹)	200 ± 43 ^a	446 ± 49	117 ± 3	129 ± 9	179 ± 6
Glycine (370 mg l ⁻¹)	200 ± 8 ^a	22 ± 6	60 ± 4	49 ± 17	69 ± 4

Solution	BOD ₅ value (mg BOD ₅ l ⁻¹)	Ferricyanide-mediated BOD ₅ values (mg BOD ₅ l ⁻¹)			
		<i>E. coli</i>	<i>B. licheniformis</i>	<i>T. citanorum</i>	<i>P. putida</i>
Glucose/glutamic acid	198 ± 30 ^a	198 ± 19 ^a	198 ± 9 ^a	198 ± 4 ^a	198 ± 12 ^a
Glucose (330 mg l ⁻¹)	200 ± 24 ^a	362 ± 45	210 ± 2	189 ± 17	228 ± 14
Glutamic acid (344 mg l ⁻¹)	200 ± 24 ^a	120 ± 6	72 ± 4	67 ± 6	139 ± 25
Sucrose (320 mg l ⁻¹)	200 ± 43 ^a	446 ± 49	117 ± 3	129 ± 9	179 ± 6
Glycine (370 mg l ⁻¹)	200 ± 8 ^a	22 ± 6	60 ± 4	49 ± 17	69 ± 4

Limitations

- The results for glutamic acid and especially glycine were poor in all cases, being considerably underestimated.
- The broad substrate range microorganisms generally underestimated the amino acid values relative to the simple sugars.

5) Luminous Bacterial Cells-Immobilized Chip

Toshifumi studied the development of a new rapid and onsite BOD monitoring system that arrayed and immobilized luminous cells on the holes (diameter: 1000 μm) of an acrylic chip [15]. Luminescence reduction or emission is due to physiological responses of luminescent microorganisms to toxic or nutrient substances has been used as a reporter signal for detection and measurement of analyte. *Photobacterium phosphoreum* was used for the measurement of biodegradable substances by various researchers.

Principle: The enzymatic reactions for light emission are closely related to oxygen (O₂) consumption. Bacterial bioluminescence which is caused by *lux* genes requires NAD(P)H and ATP for the regeneration of reduced riboflavin phosphate (FMNH₂) and a long chain fatty aldehyde [20]. The light emission is considered to be correlated with energy supplementation owing to carbon source utilization in the aerobic microbial respiration.

Material & Method: *P. phosphoreum* IFO 13896 was grown with the ATCC (American Type Culture Collection-culture medium no. 1163) at 15°C or 25°C for 15 h corresponding to the optimum conditions in order to obtain the maximum bioluminescence.

Bioluminescence was measured by a chemi-luminescence detector (Alpha Innotech 4400 or Aisin LumiVision Pro HSII) or our newly developed onsite monitoring system using a digital camera (Fuji film Fine Pix S602) (Fig 8)[15]. Cell paste (approximately 7.5 mg dry weight) that was obtained from 1.5 ml culture was prepared for immobilization to the chip holes. Ten micro liters of sodium alginate solution was added and mixed to the cell paste. After stamping cell paste with a small stick into the holes, cells were immobilized with dropping 10 μl of 1% calcium chloride solution to cell-stamped hole wells (Fig.9).150 ppm glutamate; GGA solution equivalent to

a BOD₅ value of 220 ppm was prepared for calibration of BOD values.

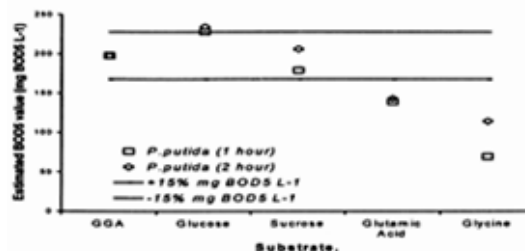

Fig.7. Response with incubation time 2hrs with *P. putida*.

Data Validation: Wastewater samples were collected from the industrial wastewater treatment plant of a confectionery. These wastewater samples were applied to the microbial chip systems (onsite and chemi-imager). The samples were diluted to 50 or 100 times by using the growth medium without the carbon source, which was treated with pure oxygen gas, if necessary. It is possible to determine the degree of pollution due to the presence of biodegradable organic substances in multiple samples by using a bacterial chip system within 20 min using one drop of just 5 μl sample. The values measured

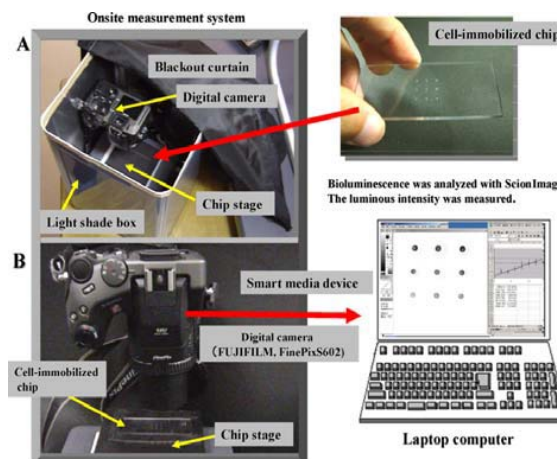

Fig. 8 Overview and measuring procedure of onsite BOD measurement system [15]

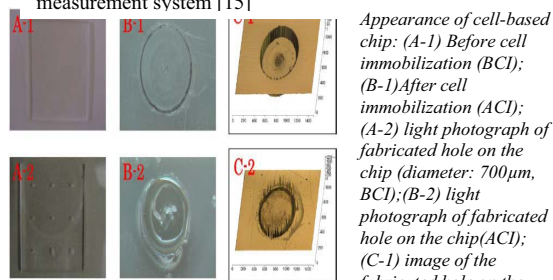

Fig. 9. Photographs and super-depth microscopic images

Appearance of cell-based chip: (A-1) Before cell immobilization (BCI); (B-1) After cell immobilization (ACI); (A-2) light photograph of fabricated hole on the chip (diameter: 700 μm, BCI); (B-2) light photograph of fabricated hole on the chip (ACI); (C-1) image of the fabricated hole on the chip (diameter: 700 μm) with a color laser microscope (BCI); (C-2) image of the fabricated hole on the chip

by using the onsite systems almost agreed within about 10% differences from values obtained using BOD₅ of standard solution. BOD values lower than 16 ppm could be directly detected without dilution of the sample. These results showed that developed system was suitable for the measurement of BOD values in natural environments such as river, pond and water drains as well as wastewaters.

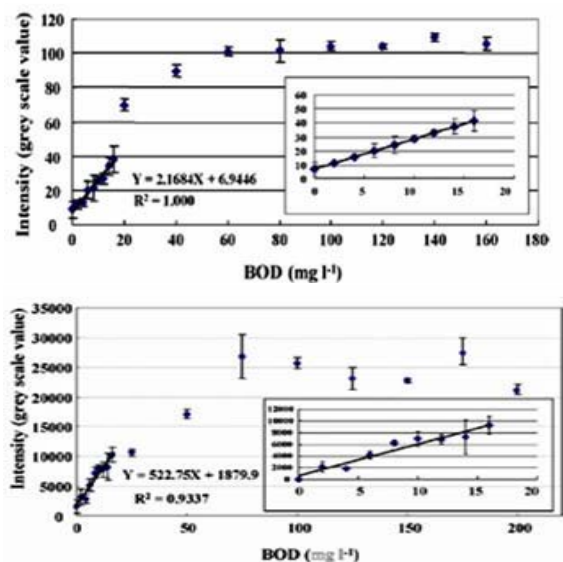

Fig. 10. Calibration curve by the chemi-imager system(a) & the onsite system(b) respectively[15].

The luminescent intensity was correlated with concentration of GGA solution. The bioluminescence increased linearly with concentration up to approximately 16 ppm. Moreover, the bioluminescence increased logarithmically with the concentrations up to approximately 60 ppm (Fig. 10(a),(b)). The light intensity has reached the saturation at the concentration of over 80 ppm.

III. CONCLUSION

Standard Methods primary weaknesses relate to the long length of the test (5 days/ 3 days) that renders responsive management difficulties. Secondly, there is a need to dilute the sample in an experiential manner to achieve a partial removal of oxygen from the sample in the five day incubation period, and the marginalized incubation temperature that is applied are other difficulties. Few advancement made in BOD measurement primarily to reduce the time and negate the measurement difficulties have been discussed in this paper. Most of the techniques are based on microbial activities.

In the BOD-BART™ method the time lag, required for the system to change from oxidative to reductive state is calculated. The study was restricted for the aerated lagoon effluents. The variability for the BOD-BART rarely exceeded 5% while the BOD₅ was larger but rarely exceeded 9% from the standard value, saving 80% of testing time.

BIOSENSORS are the biological sensing element with a transducer which produces a signal proportional to the analyte concentration. The co-immobilized microorganisms have been

shown to have expanded assimilation spectrum. Proper choice of calibration solution is needed to improve the coincidence of the sensor BOD values with the BOD₅ values.

TABLE VI
SUMMARY OF RAPID DETERMINATION METHOD

Sr. No	Title & Year	Bacter-ial Strain	Sample tested & Application	Principle	Remarks
1	BOD-BART system™ Johnston et. al., (1990)	Available in sample	Activated sludge treated municipal wastewater	Time Lag, from oxidative to reductive state	Time taken is <20-hour or <72,000 seconds
2	Ferricyanide-Mediated Rapid Determination Approach Kylie, et.al. (2001)	<i>E. coli</i> <i>Pseudomonas putid</i> , <i>Bacillus</i> and <i>Trichoporon cutaneum</i> .	Secondary treated domestic Wastewater.	The ferricyanide is used instead of oxygen mediated microbial oxidation	1) Ferricyanide is used instead of oxygen 2) Assay was achieved in 1 hrs
3	Biosensor Rastogi et. al., (2002)	<i>Citrobacter</i>	Dairy, distillery and tannery industries.	A signal proportional to the analyte concentration is produced.	2) Response time 5–10 min
4	Co-Immobilized Microbial Biosensor Sol-Gel Derived Composite Material Jianbo, et. al., (2002)	<i>T. cutaneum</i> and <i>B. subtilis</i>	Industrial effluents	Transducer to produce a signal proportional to the analyte concentration.	Sol gel derived composite material used for immobilization of bacteria. 40 min
5	Luminous Bacterial Cells-Immobilized Chip Toshifumi et.al. (2006)	<i>P. phosphoreum</i>	Industrial wastewater	Bacterial bioluminescence caused by <i>lux</i> genes due	1) Photobacterial cells-immobilized on an acrylic chip. 20 min

In Ferricyanide-mediated approach, ferricyanide has been used as e-acceptor instead of oxygen. In this method various strain of microbes were used and different type of substrate were selected with the conclusion that *P. putida* showed most promising results among all. Also the variation of the incubation time was studied and inference was drawn that there is increase in consumption of organic material with longer incubation times.

The last method that is discussed in this paper is Luminous bacterial cells-immobilized chip method in which bacterial bioluminescence which is caused by *lux* genes due reduction or emission by physiological responses is measured and correlated to BOD. The results showed that system was suitable for the measurement of BOD values in natural environments such as river, pond and water drains as well as wastewaters. It requires high precision.

Reduction in the time for the BOD test would naturally help in saving of various resources such as time, money and man power etc. However, none of these has been developed as a standard method of BOD estimation. There is a scope to further probe into the rapid estimation of BOD.

REFERENCES

- [1] Sawyer C., McCarty P., Parkin G. (2006) "Chemistry for Environmental Engineering and Sciences", Tata McGraw-Hill Publishing Company, fifth edition.

- [2] Logan, B.E. and Wagenseller G.A.(1993). The HBOD test: a new method for determining biochemical oxygen demand. *Water Environ. Res.* (65-7), p: 862-868.
- [3] APHA, Standard Methods for the Examination of Waters and Wastewater. 20th Edn.(2005). American Public Health Association, Washington, DC.
- [4] Cullimore, R., (1999), Biological Activity Reaction Tests- A simple yet effective method for monitoring Biochemical Oxygen Demand.BARTTM testers. Practical Atlas for Bacterial Identification, Lewis/CRC Press, Droycon Bioconcepts Inc. 315 Dewdney Ave. Regina, Saskatchewan, Canada S4N 0E7.
- [5] Johnston L., Cullimore R and Singh K., (1990), Field Trials of the BOD-BART system™ for the Rapid Determination of Biochemical Oxygen Demand in Secondary and Tertiary Effluents. Droycon Bioconcepts Inc, Regina, Saskatchewan, and University of New Brunswick, Fredricton, New Brunswick.
- [6] Karube, I., Matsunaga, T., Mitsuda, S., Suzuki, S., (1977.), Microbial Biosensors *Biotechnol. Bioeng.* (19), p.1535–1547.
- [7] Rastogi S, Rathee P, Saxena T.K., Mehra N.K., Kumar R.(2002) BOD analysis of industrial effluents: 5 days to 5 min, *Current Applied Physics* (3),p-191–194.
- [8] Hikuma M., Suzuki, H., Yasuda, T., Karube, I., Suzuki, S., (1979). Amperometric estimation of BOD by using living immobilized yeast, *Eur. J. Appl. Microbiol. Biotechnol.* (8), 289–297.
- [9] Ohki A, Shinohara K., Lto O., Naka K., Maeda S., Sato T., Akano H., Kato N., Kawamura Y., (1994) ,A BOD sensor using *Klebsiella Oxytoca* ASI, *Int. J. Environ. Anal. Chem.* (56),p261–269.
- [10] Jung J., Sofer S., Lakhwala F., (1995) Towards an on-line biochemical oxygen demand analyser, *Biotechnol. Tech.*(9) 289–294.
- [11] Sangeetha S, Sugandhi G., Murugesan M., Madhav V.M., Berchmans S., Rajasekar R., Rajasekar S., D., Jeyakumar G., Rao P., (1996), Immobilised Activated Sludge Based Biosensor For Biochemical Oxygen Demand Measurement, *Electroanalysis* (8),p: 698–701.
- [12] Jianbo Jia, Tang Mingyu, Xu Chen, Li Qi, Shaojun Dong. (2002), Co-immobilized microbial biosensor for BOD estimation based on sol-gel derived composite material, *Biosensors and Bioelectronics* (18), p-1023-/1029.
- [13] Dong, S., Cheng, G., Li, B., Kou, W., Zhang, J., (1996). Construction of enzyme electrodes based on PVA-g-PVP hydrogel. *Chin. Pat. CN96123528.4.*
- [14] Kylie Catterall , Kristy Morris, Huijun Zhao, Neil Pasco, Richard John. (2001), The use of microorganisms with broad range substrate utilization for the ferricyanide-mediated rapid determination of biochemical oxygen demand, *Talanta* (55),p-1187-1194.
- [15] Toshifumi Sakaguchi , Yasunori Morioka , Masahiro Yamasaki , Junpei Iwanaga , Kazuhiko Beppu, Hideaki Maeda, Yasutaka Morita , Eiichi Tamiya. (2006), Rapid and onsite BOD sensing system using luminous bacterial cells-immobilized chip, *Biosensors and Bioelectronics* (19),p-115-121.