

# Increase Energy Savings with Lighting Automation Using Light Pipes and Power LEDs

İ. Kıyak and G. Gökmen

**Abstract**—Using of natural lighting has come into prominence in constructed buildings, especially in last ten years, under scope of energy efficiency. Natural lighting methods are one of the methods that aim to take advantage of day light in maximum level and decrease using of artificial lighting. Increasing of day light amount in buildings by using suitable methods will give optimum result in terms of comfort and energy saving when the daylight-artificial light integration is ensured with a suitable control system. Using of natural light in places that require lighting will ensure energy saving in great extent. With this study, it is aimed to save energy used for purpose of lighting. Under this scope, lighting of a scanning laboratory of a hospital was realized by using a lighting automation containing natural and artificial lighting. In natural lighting, light pipes were used and in artificial lighting, dimmable power LED modules were used. Necessity of lighting was followed with motion sensors. The lighting automation containing natural and artificial light was ensured with fuzzy logic control. At the scanning laboratory where this application was realized, energy saving in lighting was obtained.

**Keywords**—Daylight transfer, fuzzy logic controller, light pipe, Power LED.

## I. INTRODUCTION

It is stated that approximately 35% of energy consumed today is used at buildings. This situation indicates that energy using and efficiency at buildings is very important. To ensure energy efficiency at buildings, it must comply with the regulations and standards on energy effective building design in force. It is forecasted that existing buildings in European countries will consume 2/3 of the energy to be used at buildings in 2050 [1]. It is known that every human activity is better carried out in presence of natural light rather than in the absence of it, due to a favorable psychological condition felt by the occupants of the building. This is probably due to the perception of the flowing of time that is unattainable when artificial light is the only light source in the room. In fact electric light sources emanate a time- independent luminous flux and produce steady illuminance on the work plane that does not allow people to perceive the passing of time [2]. However, the effective straight vertical tubes cannot be build in the sloped roofs, therefore bended guides with oppositely oriented tilted apertures are applied. These have to redirect the light flux into a vertical part of the guide and after inter

reflections deliver it downward to the ceiling interface and finally onto the work plane [3].

Daylight gives illumination for indoor activities and visual connection between interior and exterior environments, and brightens the internal spaces. Building occupants prefer natural light and an outside view. For a good interior environment, as much natural glare free light as possible is essential. Electric light fittings not only consume electricity but also dissipate sensible heat into the building space to increase the cooling load in subtropical climates. Proper use of natural light for lighting purposes in buildings can be an effective means of saving energy and reducing the environmental impact [4]. Daylight is the primary, free and the most important light source for building's internal spaces during the daytime. Adequate and efficient daylight usage can actualize the needed saving. The daylight used in the buildings is important for the visual-physical comfort and human health-efficiency as well. People spend most of their time indoors. Reducing the artificial lighting utilization, especially during the daytime, becomes more of an issue for energy saving. By using systems that would carry the daylight into the inner parts of the buildings, for both illumination and air conditioning, energy conservation could be enabled [5]. A light pipe is a construction consisting of a high reflectance closed wall with entrance and exit apertures that have high transmittances. Light pipes have been found to be useful in the illumination of the interiors of buildings where there is little light available from windows [6]. Using of natural and artificial light sources in combination to ensure energy saving in lighting has increased the importance of controlling artificial lighting. 20% of electric energy is consumed by industrial businesses, 30% by offices and 40% for purpose of lighting. The share of lighting in energy consumption constitutes the biggest item after heating and cooling systems. If it is considered that electric energy consumed for lighting at modern buildings is about 60%, the importance of energy saving in lighting may be understood better. With this regard, using of suitable artificial lighting control systems will both establish the required good sight conditions for the user and ensure energy saving [7].

The main targets for lighting of places with daylight, in addition to decrease energy consumption and ensure physiological and psychological comfort of users, are as follows:

- Effective use of daylight,
- Ensuring of proper lighting as much as possible,
- Ensuring of glaring control with protection from direct sun light,

İ. Kıyak is with the Electric-Electronic Engineering Department, Faculty of Technology, University of Marmara, İstanbul, Kadikoy 34722 Turkey (corresponding author to provide phone: +90-532-220-79-14; fax: 090-216-336-57-70; e-mail: imkiyak@marmara.edu.tr).

G. Gökmen is with the Electrical Education Department, Faculty of Technical Education, University of Marmara, İstanbul, Kadikoy 34722 Turkey (e-mail: gokhang@marmara.edu.tr).

- Establishment of visual relation with external environment,
- Sensing of qualitative and quantitative differences of external light level in a day,
- Realization of a design compatible with other physical environmental matters like climate control and noise control,
- Decreasing of artificial lighting, heating and cooling loads [8].

The recent development of new high efficient optical materials has made possible the 'day light guidance technology' which, through a large number of optical processes, redirects and transports day light over distance, i.e. into areas of buildings that cannot be lit using conventional glazing. This technology is based on the use of light pipes, that is to say mirror light guides with highly reflective surfaces, equipped with optical devices to collect both sky light and sun light flux falling on the horizontal upper opening and to forward it down ward by multiple inter-reflections onto the diffusing emitting glazing at the bottom of the tube. This diffuser scatters and redistributes transported daylight over the interior space [9]. The pipes with highly reflective internal surfaces, like aluminum sheet with reflectance of about 95–99%, became increasingly efficient. However, the amount of light and its distribution into interiors strongly depends on the properties of base glazing. Typically, the uniform distribution of indoor illumination is achieved by installing opal flashed diffusers with lambertian radiating characteristics [10]. Hospitals require 24 hour uninterrupted energy to ensure comfort and security conditions of users for purpose of giving necessary health care service. For such buildings, economical dimension of electric energy constitutes an important price. For this reason, efficient use of electric energy is important to control expenses. Hospitals have not focused on the subject of using of electric energy efficiently yet. However, to ensure energy efficiency, especially in lighting area, will be an investment returnable in a very short time [7].

Light pipes have the unique ability to transport light energy and change its direction of propagation with a high degree of efficiency. Light pipe design can increase the illumination efficiency of an entire system, which is very critical for practical applications, and has become a useful design tool. Light pipes are widely used in indoor lighting, electro optical applications, including projector engine illumination, liquid crystal panel back light systems, automobile dashboards, headlights, etc [11].

In the study, light pipes were positioned according to sections that require highest level of lighting in the room. Necessity of lighting was determined with motion sensors and in times when the natural lighting is not sufficient, dimmable power LED was used. The light level was measured with light sensors in every 5 minutes and for required light level, power LED was used. The power LED dim information to be included in the lighting realized with a light pipe was produced by using the fuzzy logic control algorithm according to the motion sensor and light sensor information.

## II. DAYLIGHT HARVESTING WITH LIGHT PIPE

In the communication passages, halls or deep interiors usually several light guides are designed in regular rows with spacing after visual requirements to be achieved successfully at least under sunny and clear sky conditions. Due to snowy and rainy winter conditions in temperate and subtropical climates sloped roofs with bended light guides can be efficient. In these countries with in geographical latitudes 35–55° traditionally the sloping roofs are often the most conspicuous features of buildings and present a familiar landscape form of houses in the countryside, especially in mountainous regions [3]. This takes into account sun light flux as well as sky light flux from different sky luminance patterns assuming various Standard skies after the ISO/CIE Standard [12]. It is known that daylight lighting value changes depending on seasons and meteorological conditions. According to the Commission of Illumination (CIE), various situations of sky and related lighting values are defined under four categories; clear weather, average, overcast weather and uniform sky models.

According to clear weather sky model; it is between 30 000 lux (winter) - 100 000 lux (summer) according to measures made on the earth. (L) Glare distribution of the sky changes depending on place of sun in the sphere. According to average sky model; the sky is not light as much as it is in clear weather and changes in lighting are not sharp as much as it is in clear weather. According to overcast sky model; sky is covered with clouds. It is between 7000 lux (winter) - 20 000 lux (summer) according to measures made on the earth. According to uniform sky model; the sky glare is constant. In arid and sunny climate regions, it is accepted as the blue sky piece that remains out of immediate vicinity of sun [13]. In Fig. 1, daylight lighting values determined by the CIE (International Commission of Illumination) are given.

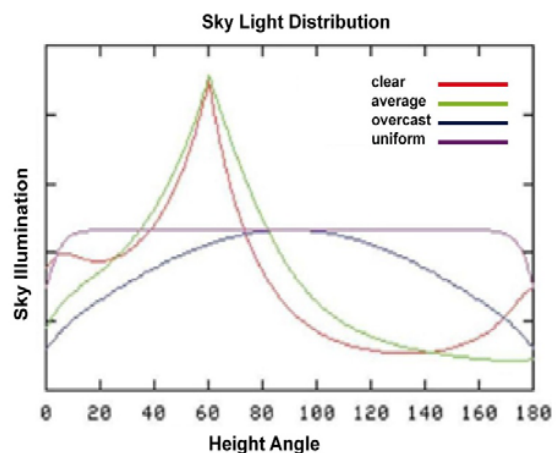

Fig. 1 The sky lighting values [13]

Mirror light pipes (MLP) are used commercially to transfer daylight from the facade of a building to the deep interior. Vertical MLP, usually of circular cross section, connect an aperture at the roof to an aperture at the ceiling. Horizontal

MLP, usually of rectangular or triangular cross section transfer daylight from the wall of a building to the interior [14]. A light-pipe system is made up of three parts. The first part is the dome collecting the diffuse and direct light and transferring into the light-pipe. The dome is produced from transparent polycarbonate material, designed to remove the undesired UV light, and this dome shape prevents snow, dust and rain from penetrating into the tube. The second part is made up of one or more hollow tubes connected to each other to transfer the collected daylight. The daylight collected by the dome reflects and reaches to the diffuser placed on the ceiling of the room. Diffuser, making up the last part of the light-pipe system, is generally produced from white polycarbonate material. It allows the daylight coming from the light-pipes to be diffused into the room [5]. In Fig. 2 light pipe components are shown.

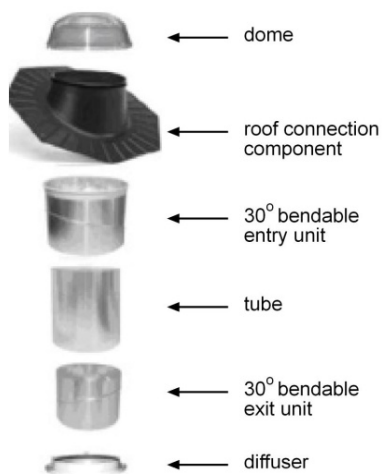

Fig. 2 Light pipe components [15]

As a consequence, manufactures of guidance systems should provide a detailed characterization of light transmission efficiency for a wide range of sun positions and sky conditions, as efficiency performances depend on the presence of the sun in the sky as well as on its position during the day and throughout the year. If photometric data of guidance systems are scarcely available, methods are required to accurately predict the light transmission efficiency of complex guidance systems. In principle, three approaches could be adopted for this purpose: analytical methods, numerical simulations and measurements using real systems, each with different advantages and drawbacks [9]. Light entering the Mirror light pipe (MLP), whose entrance aperture is typically on the roof of a building, is reflected along the length of the pipe and leaves the pipe most commonly through a diffuser at the exit aperture that spreads the light, if not isotropically, then to a sufficient degree to provide illumination over a usable area and to overcome any severe glare problems. MLPs have found a niche in the lighting market for the illumination of small rooms, although some work has been aimed at the lighting of larger spaces through the use a number of pipes [6].

In Fig. 3, storeroom lighting shown that illuminated by light pipes.



Fig. 3 Storeroom illuminated by light pipes

### III. THE COMBINATION OF NATURAL AND ARTIFICIAL LIGHTING

Areas away from the windows can be illuminated with natural light during the daytime by using light-pipes. However, depending on the weather condition, sometimes daylight coming from the light-pipe is not sufficient for illumination. During these times, when natural lighting is not adequate or more lighting is needed, artificial lighting is used. However, generally, all the artificial lighting components are operated together without taking the intensity of the illumination into consideration. This in turn, causes in efficient energy use. Control systems can be used for illumination systems. Savings in energy consumption for lighting can be achieved by controlling the system with methods such as switching on-off by user, manual or automatic dimmers with timers or demand control, etc. Artificial lighting may be operated gradually according to the illumination level achieved by natural lighting in the environment [5].

Lighting control can be ensured in artificial lighting or natural lighting by making changes or additions in some specifications of light sources depending on physical features of the place. Lighting of a place must be made with an ideal combination of natural and artificial light. To ignore natural lighting in interior places where it is tried to approach artificial light sources to natural light sources will be inappropriate both in terms of energy efficiency and user needs [7]. In Fig. 4, a lighting system on which both the light pipe and fluorescent lamp systems are used in combination is given.

Locations of artificial light sources that ensure lighting in a place must be established within the framework of a definite plan. For this reason, in a place where many sources are used in combination depending on the function of place and needs of users, it will be needed a lighting order. Controlling of lighting order by a system constitutes the lighting control systems. Elements that establish an artificial lighting control

system, besides to lighting sources, are; motion, daylight, heat sensors, dimming units, timers and computer control units [7].



Fig. 4 A place where both natural and artificial light sources are used

In indoor areas that require artificial light, by considering the hours the user presents in the indoor area and the hours when the place take advantage of natural light, the artificial lighting can be controlled automatically with programming of control system. In this way, problems experienced in lighting that is controlled manually will be eliminated. As the lighting level will be kept in desired level at every hour of day with lighting scenarios created by considering the natural lighting, it will be saved from electric energy [7].

In the daylight designs and researches, the daylight lighting value is a basic element. The basis of studies about assessment of natural lighting performances of buildings carried out for designing of daylight control systems is depended on natural lighting values of places and working area lighting values. The daylight designs depend on distribution of said lighting values inside of the building. Knowing of daylight lighting values and their distribution inside of the building is important in terms of energy efficiency of the building and assessment of its visual comfort. For this purpose, various design instruments are suggested. These include various standards, mathematical calculation methods, computer programs and model making [16].

Light pipes can be defined as an empty tube that enables lighting of places without sun light. Diameters of commercial light tubes changes between 200mm and 1500mm depending on size of place to be illuminated and their lengths can be up to 9m. When compared to roof window and other windows, it has lesser heat transmission. In addition to lighting, there are light pipes that have natural or mechanical ventilation systems [15]. In Table I, lumen equivalences of lighting value of the light pipe are given.

TABLE I  
LIGHT PIPE LUMEN EQUIVALENCES [15]

Light pipe diameter	Light output (lumen)	Equal as electric lamp
10in/250mm	3000~4600lm	3350lm T8 lamp 1~2 unit
14in/350mm	6000~9100lm	3350lm T8 lamp 2~3 unit
21in/530mm	13900~20800lm	3350lm T8 lamp 4~6 unit

in=inch, mm= millimeter, lm= lumen

#### IV. APPLICATION PROJECT

In this project, the lighting automation consisted of natural and artificial lights of a place that located on the last floor of a hospital and had no window architecturally in inner section was realized. The project place consisted of two sections. There was a scanning device in the section called as scanning room and a working table and cabinets in the section called as working room.

At hospitals, the lighting levels required in places where health care service is given were determined according to the functions determined in the book of CIBSE named 'Code for Interior Lighting'. Accordingly to the lux levels determined depending on the lumen/m<sup>2</sup> calculation; general lighting of doctor rooms must be 100-200 lux, local lighting be 400-800 lux, diagnosis rooms be 250-1000 lux, operation rooms' general lighting be 500-1000 lux, operation table local lighting be 20000-40000 lux, sterilization room be 400-800 lux, dental chair and delivery chair be 5000-1000 lux and baby room be 100-200 lux [7].

##### A. Architectural and Lighting Information about the Place

Application place measures- 3.5 X 4.5 X 3.2m- consist of two sections as scanning and working (doctor) rooms. Annual insulation and lighting data were obtained from the General Directorate of Meteorology. From these data, a 24-hour average lighting data bank was established for overcast, cloudy and clear (sunny) days. For natural lighting, two numbers of light pipes in diameter of 350mm were placed in each two rooms. The light pipes had thickness of 13mm and aluminum alloy coated interior surface with reflection coefficient of 0.98.

Total length of light pipes was 9.5m from roof to interior area. The light pipes were positioned vertically to the place from the roof, except one 150° arch at the 4<sup>th</sup> meter from the roof. In designing of artificial lighting, by considering the times no light could be obtained from the light pipe, power LED module was used as a lighting element. Power LED module was in power of 20 W, had aluminum alloy passive cooler, 60° directed reflector and 6500K color temperature. The average lighting level of working space (85cm) according to standards was determined as 300 lux for the scanning room and 120 lux for the working (doctor) room. As a result of the calculations made, to ensure the determined lighting level, it was decided to use 9 numbers of power LED modules for the scanning room and 3 numbers of power LED modules or the working (doctor) room. In Fig. 5 (a) and (b) natural and artificial lighting elements positioning plan for the scanning and doctor rooms is given.

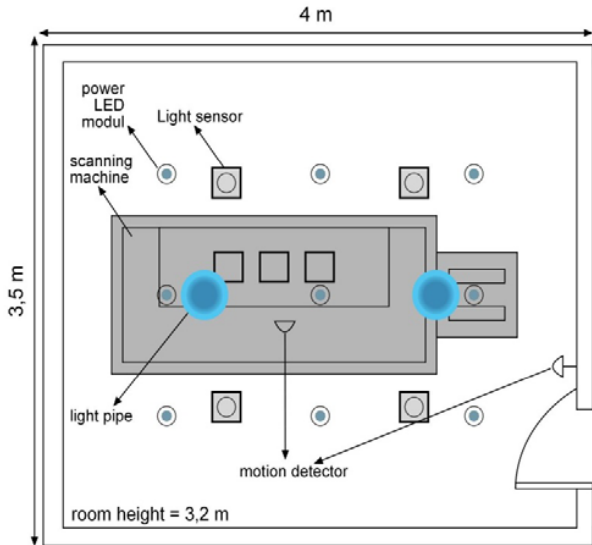

Fig. 5 (a) Positioning of natural and artificial lighting elements for the scanning and doctor rooms

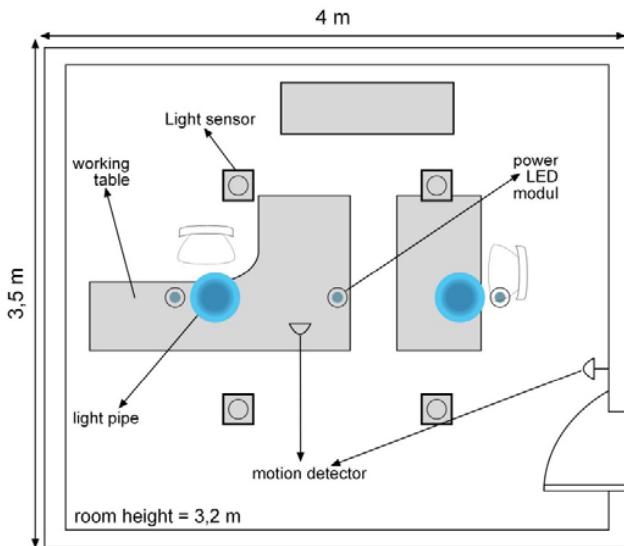

Fig. 5 (b) Positioning of natural and artificial lighting elements for the scanning and doctor rooms

**B. Controlling of LED Lamps with Fuzzy Controller**

Two fuzzy controllers were designed for the working (doctor) room and scanning room. The lighting levels of rooms (LL) and lighting level of the pipes (LP) were measured with sensors and then their mean values were transferred to real-time simulation circuit in the Matlab Simulink by means of DAQ card (Fig. 6). Fuzzy controllers have two inputs and one output. Inputs are LL and LP respectively. The output is the control voltage (CV) that ensures dimming of LED lamps. (Figs. 6 and 7) [17]-[21].

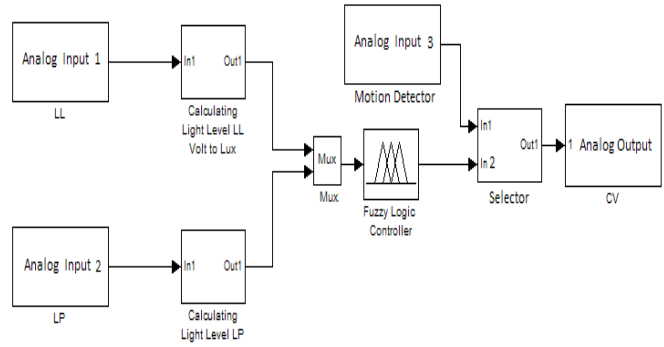

Fig. 6 Simulink circuit used in simulation

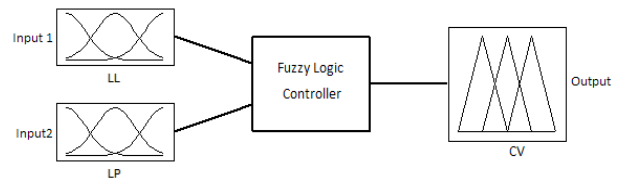

Fig. 7 Fuzzy controller

Input and output variables consist of four triangle membership functions. Linguistic expressions of these membership functions are; Too Low Bright (TLB), Low Bright (LB), Bright (B) and Very Bright (VB).

Ranges of the first input variables for both rooms (LL) were arranged by also considering the tolerances according to the data obtained from sensors. Ranges are 0-310 lux for the scanning room are 0-125 lux for the working (doctor) room (Figs. 8 and 9).

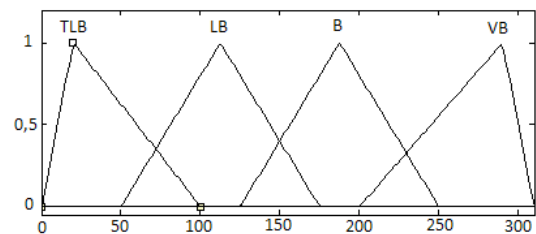

Fig. 8 The first input (LL) membership functions of the scanning room fuzzy controller

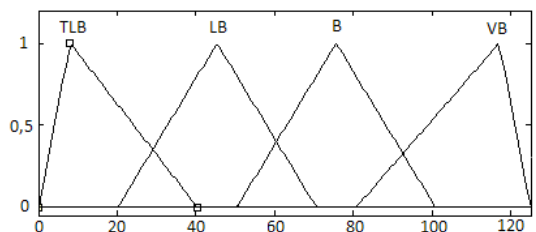

Fig. 9 The first input (LL) membership functions of the working (doctor) room fuzzy controller

Ranges of the second input variables for both rooms (LP) were arranged according to the mean of data obtained from sensors. The ranges are same for both rooms (0-95 lux). Because, similar luminous flux is transferred to rooms with the light pipe (Fig. 10).

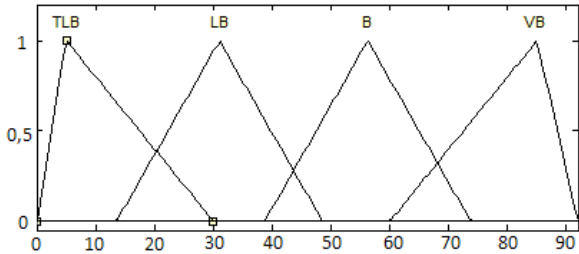

Fig. 10 The second input (LL) membership functions of the scanning room fuzzy controller

Ranges of output variables (CV) of two controllers are different from each other because desired lighting levels are not the same (For scanning and working room). They are 6-11 V for the scanning room and 2-11 V for the working (doctor) room (Figs. 11 and 12).

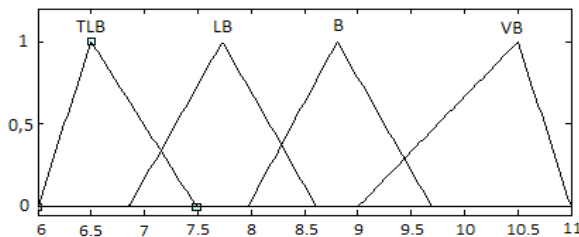

Fig. 11 Output (CV) membership functions of the scanning room fuzzy controller

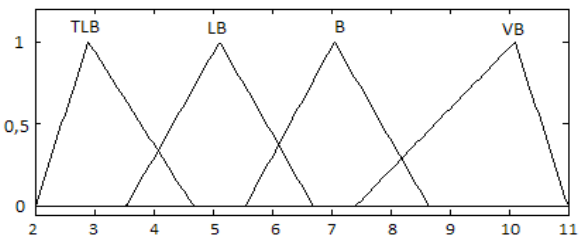

Fig. 12 Output (CV) membership functions of the working (doctor) room fuzzy controller

The rule matrix was arranged according to desired lighting level of rooms (Table II). As a fuzzy inference method, Mamdani was preferred [17]-[21].

TABLE II  
THE RULE MATRIX

		LP				
Input 1		VB	B	LB	TLB	
Input 2	VB	VB	B	LB	TLB	
	B	TLB	LB	B	VB	
	LB	TLB	B	VB	VB	
	TLB	B	VB	VB	VB	

After fuzzy inference, Centroid (Finding of Area Center), as one of the mostly preferred defuzzification methods, was preferred [17]-[21].

For scanning room, the control voltage obtained with fuzzy controller and changes of lighting levels of the place, were given in Figs. 13-15 respectively, according to three weather conditions; overcast weather, cloudy weather and clear (sunny) weather.

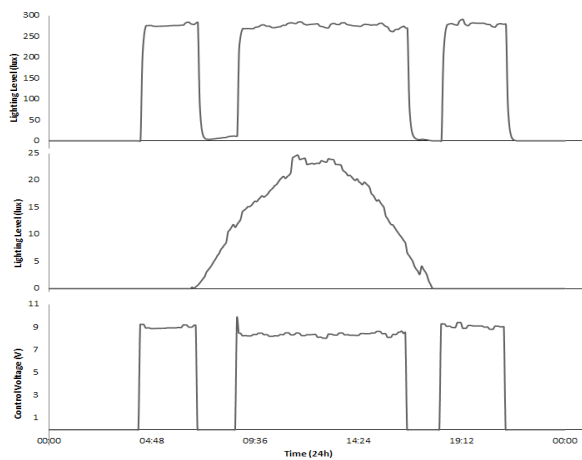

Fig. 13 LL, LP and CV values of scanning room fuzzy controller in overcast weather

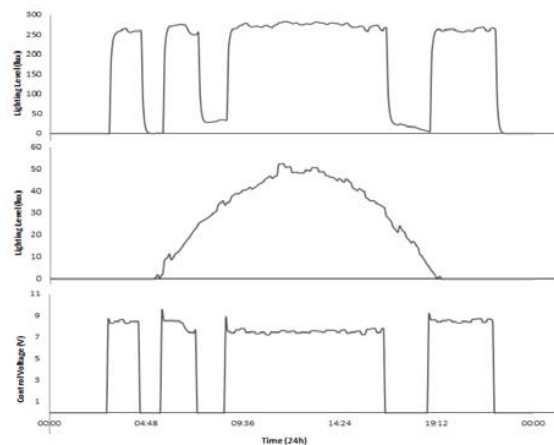

Fig. 14 LL, LP and CV values of scanning room fuzzy controller in cloudy weather

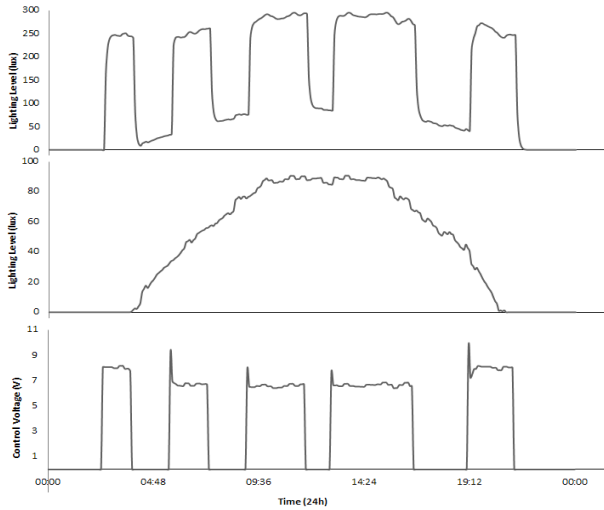

Fig. 15 LL, LP and CV values of scanning room fuzzy controller in sunny weather

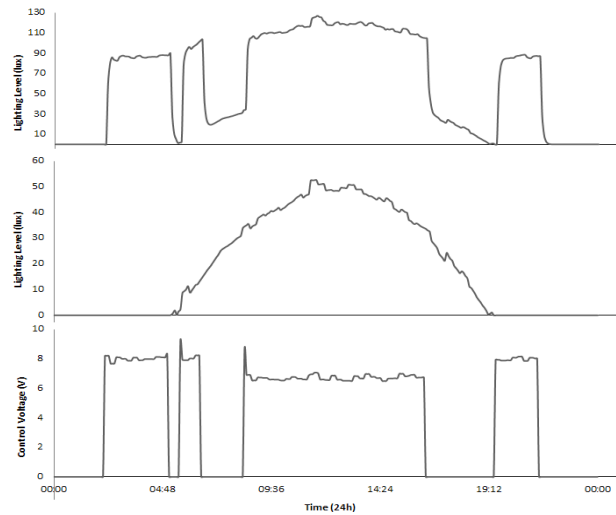

Fig. 17 LL, LP and CV values of working (doctor) room fuzzy controller in cloudy weather

Similarly, for the working (doctor) room, fuzzy controller was used to determine the lighting level in overcast weather, cloudy weather and clear (sunny) weather conditions and it was tried to keep the lighting level in the room constant as much as possible (Figs. 16-18).

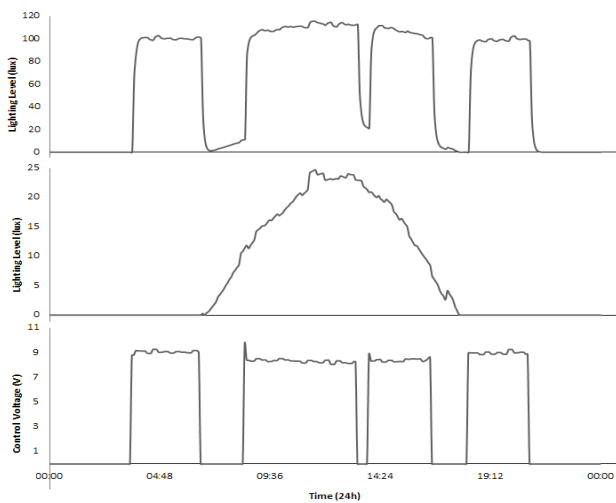

Fig. 16 LL, LP and CV values of working (doctor) room fuzzy controller in overcast weather

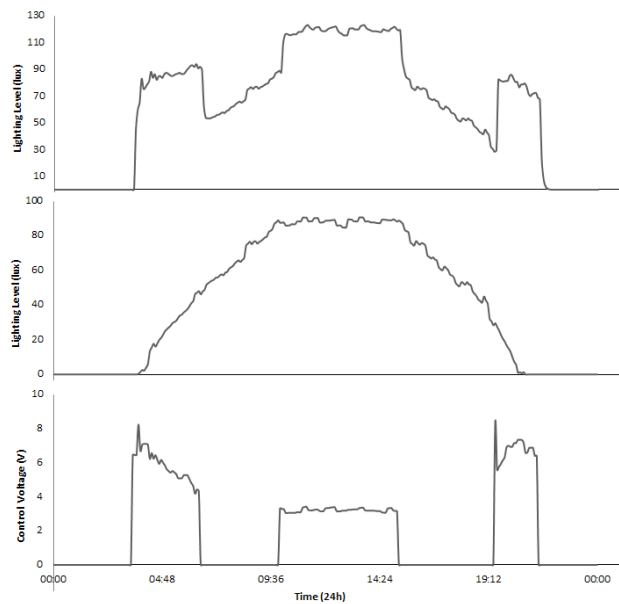

Fig. 18 LL, LP and CV values of working (doctor) room fuzzy controller in sunny weather

When the above figures are examined, it is seen that control voltage sometimes dropped to 0 V because the motion sensor opens the circuit. When no motion was recognized, lighting levels in the rooms only depended on the luminous flux transferred from the light pipe.

#### V. CONCLUSION

In this study, with combination of three factors, effective lighting and energy saving was tried to be realized. The first factor was adjustment of lighting level of rooms flexibly by using a fuzzy controller. The second factor was using of light pipes. In this manner, by transferring daylight to rooms where daylight could not reach in a day time, energy saving in great

extent was ensured. The third factor was using of motion sensors; in this manner, LED lamps would turn on only when a motion existed and turn off, when no motion existed.

For the scanning room, the average lighting level was tried to be kept at level of 300 lux. The control voltage produced by the controller was between 8.2-9.8V while the weather was overcasted, between 8.3-9.6V while the weather was cloudy and between 6.4-9.2V while the weather was sunny.

For the working (doctor) room, the average lighting level was tried to be kept at level of 100 lux. The control voltage produced by the controller was between 8.1-9.3V while the weather was overcasted, between 8.1 -9.3V while the weather was cloudy and between 3-9.3V while the weather was sunny.

The previously used lighting elements in the application places were 40W T8 fluorescent lamps without reflector; 6 numbers in the scanning room and 2 numbers in the working room. 1-month energy consumption of places used 10 hours a day was calculated as 96.6kWh. When the lighting power was compared, by using only power LED module instead of fluorescent lamp in the application places, about 25% energy saving was ensured. When the energy consumption was examined in 2013 March, one month after the project completion date, it was determined as 41.73 kWh with daily 10-hour usage. According to this datum, with natural lighting supported power LED lighting automation, energy saving in rate of 43.2% for 2013 March was ensured.

Consequently, it was observed that the suggested method enabled both flexible and effective lighting and ensured energy saving by using the daylight.

#### ACKNOWLEDGMENT

This project is supported by Marmara University Scientific Research Projects Commission; under project no FEN-D-220513-0215.

#### REFERENCES

- [1] F. D. Aykal, B. Gümüő and Y.B. Özbudak Akça, "Sürdürülebilirlik kapsamında yenilenebilir ve etkin enerji kullanımının yapılarda uygulanması", V. Yenilenebilir Enerji Kaynakları Sempozyumu YEKSEM'09, Diyarbakır- Türkiye, 19-22 Haziran 2009, s. 78-83.
- [2] C. Baroncini, O. Boccia, F. Chella and P. Zazzini, "Experimental analysis on a 1:2 scale model of the double light pipe, an innovative technological device for daylight transmission", Solar Energy, v. 84, pp. 296-307, 2010.
- [3] M. Kocifaj, F. Kundracik, S. Darula and R. Kitler, "Availability of luminous flux below a bended light-pipe: Design modelling under optimal daylight conditions", Solar Energy, v. 86, pp. 2753-2761, 2012.
- [4] D. H.W. Li , E. K.W. Tsang, K.L. Cheung and C.O. Tam, "An analysis of light-pipe system via full-scale measurements", Applied Energy, v. 80, pp. 799-805, 2010.
- [5] S. Görgülü and N. Erken, "Energy saving in lighting system with fuzzy logic controller which uses light-pipe and dimmable balast", Energy and Buildings, v. 61, pp. 172-176, 2013.
- [6] P.D. Swift, "Splayed mirror light pipes", Solar Energy, v. 84, pp. 160-165, 2010.
- [7] D. Altuncu and B. Tansel, "Aydınlatma kontrol sistemlerinin hastanelerde kullanımı", V. Ulusal Aydınlatma Sempozyumu, İzmir, Türkiye, 7-10 Mayıs 2009, s. 51-62.
- [8] A.K. Yener, "Binalarda günışığından yararlanma yöntemleri: Çağdaş teknikler", VIII. Ulusal Tesisat Mühendisliği Kongresi, İzmir, Türkiye, 25-28 Ekim 2007, s. 231-241.
- [9] R.M. Valerio, L. Verso, A. Pellegrino and V. Serra, "Light transmission efficiency of daylight guidance systems: An assessment approach based on simulations and measurements in a sun/sky Simulator", Solar Energy, v. 85, pp. 2789-2801, 2011.
- [10] M. Kocifaj, "Analytical solution for daylight transmission via hollow light pipes with a transparent glazing", Solar Energy, v. 83, pp. 186-192, 2009.
- [11] S.C. Chu, Y.K. Cheng and J.L. Chern, "Equiangular-spiral bent lightpipes with arbitrary bent angle", Optics Communications, v. 282, pp. 1976-1983, 2009.
- [12] ISO-International Standardisation Organisation, 2004. Spatial Distribution of Daylight CIE Standard General Sky. ISO Standard 15409:2004.
- [13] H.Okutan, "Gün Işığı İle Aydınlatmanın Temel İlkeleri Ve Gelişmiş Gün Işığı Aydınlatma Sistemleri", 18th International Energy and Environment Fair and Conference, İstanbul, Türkiye, 25 - 26 - 27 April, 2012, s. 41-54.
- [14] I. Edmonds, "Light transmission efficiency of daylight guidance systems: An assessment approach based on simulations and measurements in a sun/sky Simulator", Solar Energy, v. 84, pp. 928-938, 2010.
- [15] S. Görgülü, S. Kocabey, İ. Yüksek and B. Dursun, "Enerji Verimliliğı Kapsamında Yapılarda Doğal Aydınlatma Yöntemleri: Kırklareli Örneğı", Uluslararası II.Trakya Bölgesi Kalkınma ve Girişimcilik Sempozyumu, Kırklareli, Türkiye, 1-2 Ekim 2010, s. 24-36.
- [16] Z.T. Kazanasmaz, M. Günaydın and S. Binol, "Bürolarda günışığı aydınlık değerlerinin öngörülmesi", IX. Ulusal Tesisat Mühendisliği Kongresi, İzmir, Türkiye, 6-9 Mayıs 2009, s.811-822.
- [17] G. Gökmen, T. Ç. Akıncı, M. Tektaş, N. Onat, G. Koçyigit and N. Tektaş, "Evaluation of Student Performance in Laboratory Applications using Fuzzy Logic" World Conferences on Educational Sciences (WCES 2010), Bahcesehir University, İstanbul, Turkey, 04-08 February 2010, pp. 902-909.
- [18] H. J. Zimmermann, "Fuzzy Set Theory and Its Applications", London: Kluwer Academic Publisher. 2001, pp. 80-182.
- [19] G. J. Klir and T. A. Folger, "Fuzzy Set Uncertainty and Information", New Jersey, Prentice Hall, 1988, pp. 1-34.
- [20] The Mathworks. (2013). Fuzzy Logic Toolbox User's Guide, The Mathworks Inc. Retrieved April 10 2013 from, [http://www.mathworks.com/help/pdf\\_doc/fuzzy/fuzzy.pdf](http://www.mathworks.com/help/pdf_doc/fuzzy/fuzzy.pdf) pp. 78-98.
- [21] T. J. Ross, "Fuzzy Logic with engineering applications", McGraw-Hill, Inc., 1995, pp. 71-91.

**İ. Kıyak** was born in Bolu, Turkey, in 1977. He received the B.S degree from Marmara University in 2000 and the M.S and PhD degree from Institute of Pure and Applied Sciences of Marmara University in 2005 and 2010 respectively. In 2013 he was appointed Assistant Professor in Electric and Electronic Engineering Department, Faculty of Technology, University of Marmara . His current interests are measurement methods, renewable energy, power LED lighting.

**G. Gökmen** was born in Mersin, Turkey, in 1974. He received the B.S degree from Marmara University in 1996 and the M.S and PhD degree from Institute of Pure and Applied Sciences of Marmara University in 2000 and 2006 respectively. In 2008 he was appointed Assistant Professor and in 2012 he was appointed Associate Proföör in Electrical Education Department, Faculty of Technical Education, University of Marmara . His current interests are measurement methods, signal processing techniques, vocational education.