

Analysis on Modeling and Simulink of DC Motor and its Driving System Used for Wheeled Mobile Robot

Wai Phyo Aung

Abstract—Wheeled Mobile Robots (WMRs) are built with their Wheels' drive machine, Motors. Depend on their desire design of WMR, Technicians made used of DC Motors for motion control. In this paper, the author would like to analyze how to choose DC motor to be balance with their applications of especially for WMR. Specification of DC Motor that can be used with desire WMR is to be determined by using MATLAB Simulink model. Therefore, this paper is mainly focus on software application of MATLAB and Control Technology. As the driving system of DC motor, a Peripheral Interface Controller (PIC) based control system is designed including the assembly software technology and H-bridge control circuit. This Driving system is used to drive two DC gear motors which are used to control the motion of WMR. In this analyzing process, the author mainly focus the drive system on driving two DC gear motors that will control with Differential Drive technique to the Wheeled Mobile Robot . For the design analysis of Motor Driving System, PIC16F84A is used and five inputs of sensors detected data are tested with five ON/OFF switches. The outputs of PIC are the commands to drive two DC gear motors, inputs of H-bridge circuit .In this paper, Control techniques of PIC microcontroller and H-bridge circuit, Mechanism assignments of WMR are combined and analyzed by mainly focusing with the "Modeling and Simulink of DC Motor using MATLAB".

Keywords—Control System Design, DC Motors, Differential Drive, H-bridge control circuit, MATLAB Simulink model, Peripheral Interface Controller (PIC),Wheeled Mobile Robots.

I. INTRODUCTION

CONTROL System Design and Analysis Technologies are widely suppress and very useful to be applied in real-time development. Some can be solved by hardware technology and by the advance used of software, control system are analyzed easily and detail. DC Motors can be used in various applications and can be used as various sizes and rates. As an application of Wheeled Mobile Robot, DC Motor can be used as wheel drive machines and by using a simple controller of PIC16F84A, the rotation of Motors or the Motion of Robot can be controlled easily. An Obstacle Avoidance Mobile Robot can be designed using a PIC and obstacles detected Sensors. As a Wheeled Mobile Robot, depend on its drive

techniques, their wheels are drive by DC Motors. For the Differential Drive of WMR, the two left/right wheels are driven with each DC gear motor. This is the concept of the Robotic Technology and DC Motors and its driving system.

For the DC Motor Modeling, it can be analyzed with control techniques of Step response, Impulse response and Bode plot by using MATLAB Simulink. All data based on the internal circuit of a simple DC Motor and its features can be analyzed both by Control System design calculation and by MATLAB software. By the effect of MATLAB modeling results of DC Motors, all others types of DC Motors can be chosen with their desire applications. Combination of Control technology and Robot technology are now become real-time challenges. By the advance control analysis of easiest way, high-tech can be solved with the help of Modeling and Simulink using MATLAB. This is the concept of DC Motor Control and MATLAB software.

The paper is mentioned on the basic research of developing a Wheeled Mobile robot. This is a type of Sensor-based Mobile Robot and it mainly function as an Obstacle Avoidance Vehicle. All these processes are design in this research and it is mainly focus to analyze the DC gear motor by using MATLAB. This is the concept of the whole paper with using techniques, hardware and software:

Hardware: PIC, DC Motors, H-bridge circuit

Software: Assembly used in PIC STARTPLUS, M-file programming, Modeling and Simulink used in MATLAB.

II. MODELING A DC MOTOR

To be modeling a DC Motor, simple circuit of its electrical diagram as shown in Fig. 1 is considered. To be Modeling and Simulate the DC motor, the following steps are to be made step by step;

Step1: Represent the DC motor circuit diagram.

Step2: Represent system equations

Step3: Calculate the Transfer function

Step4: Convert to model block

Step5: Create the m file to simulate the model.

Step6: Analysis

A. Closed-Loop System Consideration

To perform the simulation of the system, an appropriate model needs to be established. Therefore, a model based on the motor specifications needs to be obtained. Fig. 1 shows

Manuscript received November 15, 2007. This work was supported in part by the Ministry of Science and Technology, Union of Myanmar.

Wai Phyo Aung is with the Mandalay Technological University, Mandalay, Myanmar (phone: 095-2-88704 (Electronic Engineering Department), fax: 095-2-88702 (Office,MTU), e-mail: aungwp@gmail.com).

the DC motor circuit with Torque and Rotor Angle consideration.

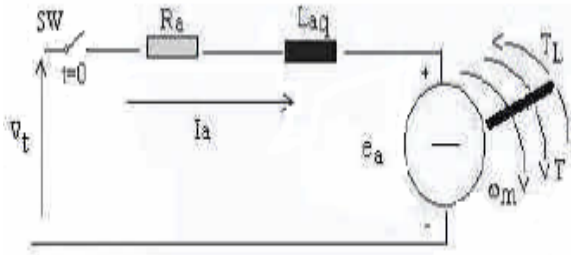

Fig. 1 Schematic Diagram of a DC Motor [6]

B. System Equation

The motor torque T is related to the armature current, i , by a torque constant K ;

$$T = Ki \quad (1)$$

The generated voltage, e_a , is relative to angular velocity by;

$$e_a = K\omega_m = K \frac{d\theta}{dt} \quad (2)$$

From Fig. 1 we can write the following equations based on the Newton's law combined with the Kirchoff's law:

$$J \frac{d^2\theta}{dt^2} + b \frac{d\theta}{dt} = Ki \quad (3)$$

$$L \frac{di}{dt} + Ri = V - K \frac{d\theta}{dt} \quad (4)$$

C. Transfer Function

Using the Laplace transform, equations (3) and (4) can be written as:

$$Js^2\theta(s) + bs\theta(s) = KI(s) \quad (5)$$

$$LsI(s) + RI(s) = V(s) - Ks\theta(s) \quad (6)$$

where s denotes the Laplace operator. From (6) we can express $I(s)$:

$$\frac{[I(s) = V(s) - Ks\theta(s)]}{R + Ls} \quad (7)$$

and substitute it in (5) to obtain:

$$Js^2\theta = bs\theta(s) = \frac{K(V(s) - Ks\theta(s))}{R + Ls} \quad (8)$$

This equation for the DC motor is shown in the block diagram in Fig. 2. From equation (8), the transfer function from the input voltage, $V(s)$, to the output angle, θ , directly follows:

$$Ga(s) = \frac{\theta(s)}{V(s)} = \frac{K}{\{s[(R + Ls)(Js + b) + K^2]\}} \quad (9)$$

From the block diagram in Fig. 2, it is easy to see that the transfer function from the input voltage, $V(s)$, to the angular velocity, ω , is:

$$Gv(s) = \frac{\omega(s)}{V(s)} = \frac{K}{\{(R + Ls)(Js + b) + K^2\}} \quad (10)$$

D. MATLAB Representation

To represent the model with m-file, we can perform the Fig. 2 data as follows;

```
A = tf(1, [L R]);
I = feedback(A, K);
T = I*K;
Gs=T*tf(1,[J b]);
Ga=tf(1,[1 0])*Gs;
```

'tf' means transfer function of data in its block and 'feedback' function is also used. And then the DC motor's rating in each part can be outputted as follows;

```
Gs.InputName = 'Voltage';
Gs.OutputName = 'Speed';
Ga.InputName = 'Voltage';
Ga.OutputName = 'Angle';
I.InputName = 'Voltage';
I.OutputName = 'Current';
T.InputName = 'Voltage';
T.OutputName = 'Torque';
```

Before any consideration of the above equations, we must know the constant values of data, K , J , b , V , L and R . This is very important to the application of DC motor which we will be used. The motor specification of DC Motor which will be used as motion control machine of Wheeled mobile Robot are firstly assigned and require as follows;

Power $P = 8$ watts, Speed $N = 5000$ rpm_(max), rotor inertia J is assumed to be 0.01 and Supply voltage $V_t = 12$ volts.

Therefore for the max speed rpm of 5000 , it can be calculate the torque constant K ;

$$\omega_m = \frac{V_t}{K} = \frac{(2\pi N)}{60} \quad (11)$$

$$K = 0.023 \text{ and } \omega_m = 524 \text{ radsec}^{-1}$$

By using equation 3, for $\omega = \frac{d\theta}{dt}$

$$K \times i = \frac{d\omega}{dt} + b\omega$$

At the steady state (used as analyzed data), both I and ω are stabilized;

$$\frac{d\omega}{dt} = 0$$

And $T = \frac{P}{W}$; where W mentioned as the minimum

possible speed to rotate the DC motor, 1200 rpm;

$$T = 15.27 \text{ mNm}$$

Therefore, the total equivalent damping b can be chosen the value of;

$$(0.023 \cdot 0.663) - b (524) = 0$$

$$b = 0.00003$$

By calculating and assuming the require data as above, the

following value are assigned to be used for our desire DC Motor Model.

$$V=12; J=0.01; b=0.00003; K=0.023; R=1; \text{ and } L=0.5;$$

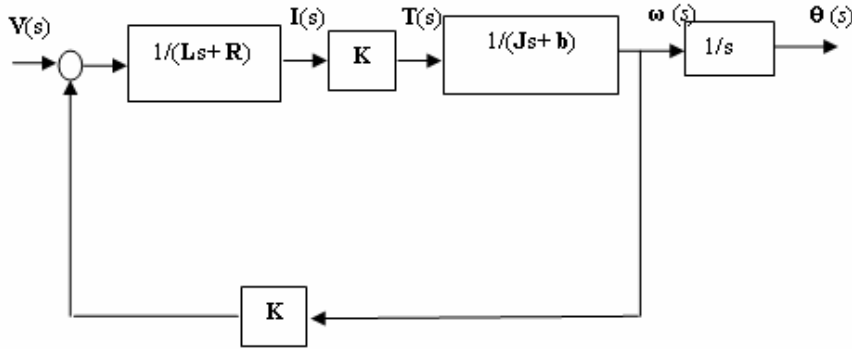

Fig. 2 A Closed-loop System that Representing the DC motor

E. Analysis

As we may want plot the responses for the velocity and angle in one figure, it convenient to group the two transfer functions into a single system with one input, the voltage, and two outputs, the velocity and the angle:

$$G = [Gv; Ga];$$

Another way is to first convert Ga into its state-space representation and then add one extra output being equal to the second state (the velocity):

$$G = ss(Ga);$$

```
set(G,'c',[010;001],'d',[0;0],'OutputName',{'Velocity','Angle'});
```

This extension of the state-space model with an extra output has to be done in one set command in order to keep the dimensions consistent. Now, we can plot the step, impulse and frequency responses of the motor model:

```
figure(1); step(G,0:0.5:10);
figure(2); impulse(G,0:0.5:10);
figure(3); bode(G,0:0.5:10);
```

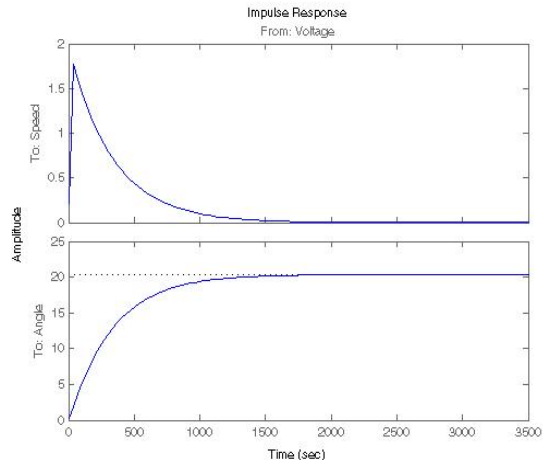

(a)

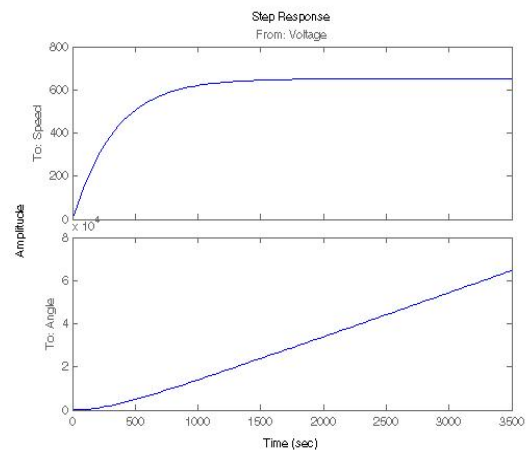

(b)

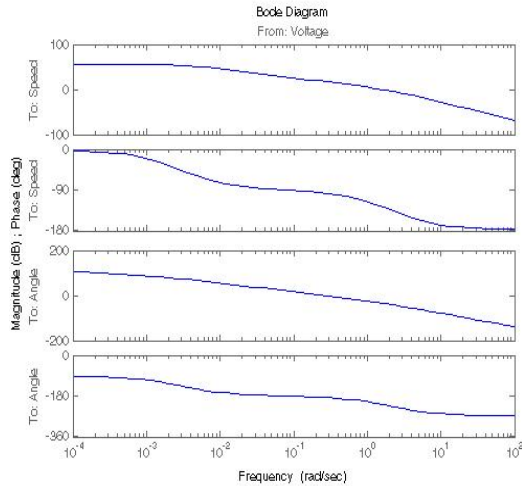

(c)

Fig. 3 Step, Impulse Responses and Bode plot

We can get the plots given in Fig. 3. Also we can analyze on each part of DC Motor rating as follows;

```
figure(4); step(I,0:0.5:10);
figure(5); impulse(I,0:0.5:10);
figure(6); bode(I,0:0.5:10);
figure(7); step(T,0:0.5:10);
figure(8); impulse(T,0:0.5:10);
figure(9); bode(T,0:0.5:10);
```

III. SIMULINK MODEL

The block diagram of Fig. 2 can be represented and created as a model as shown in Fig. 4. The approaching to construct this model can easily be done by using Simulink Library.

The M- file and Simulink model can be combined by the following commands and these are commands used in M-file which can be solve it.

```
sim('dctest.mdl',1.5)
figure (10);
```

```
subplot (4,1,1) % plot the torque vs. time
plot (y(:,4),y(:,2),'m');
title ('Torque T')
ylabel ('T in N.m')
```

```
subplot (4,1,2) % plot the speed vs. time
plot (y(:,4),y(:,1),'y');
title ('Rotor speed')
```

```
ylabel ('Wm in rad/sec')
subplot (4,1,3) % plot the angle vs. time
plot (y(:,4),y(:,5),'b')
title ('Angle');
ylabel ('theta in rad')
```

```
subplot (4,1,4) % plot the angle vs. time
plot (y(:,4),y(:,3),'g')
title ('Current');
xlabel ('time in sec')
ylabel ('I in Amp')
```

IV. DC MOTOR DRIVE SYSTEM USED FOR DIFFERENTIAL WMR

A. General Operation

Fig. 5 shows the Schematic Circuit Diagram of the PIC-based DC motor drive system that support one part of the author's research.

TABLE I
WMR DRIVING RESULTS DEPEND ON TWO MOTORS

Left motor	Right motor	WMR Drive
Clockwise	Clockwise	Go forward
Clockwise	Counter-CW	Stop
Counter-CW	Clockwise	Stop
Counter-CW	Counter-CW	Go backward
Stop	Clockwise	Go to Right
Clockwise	Stop	Go to Left

Differential Drive is defined as the two differential states of Motors can be controlled the control circuit. It used very simple statement of processes and for PIC itself; the program will take only a few memory. For all type of control system that used H-bridge circuit, the input state of DC Motor condition are all follows and it can be clearly mean that the controller must be made to control the desire drive position with its output. It can be known that current will flow in the right ways to drive the motor in only two states. When transistor 1 and transistor 3 are ON or when transistor 2 and transistor 4 are ON.

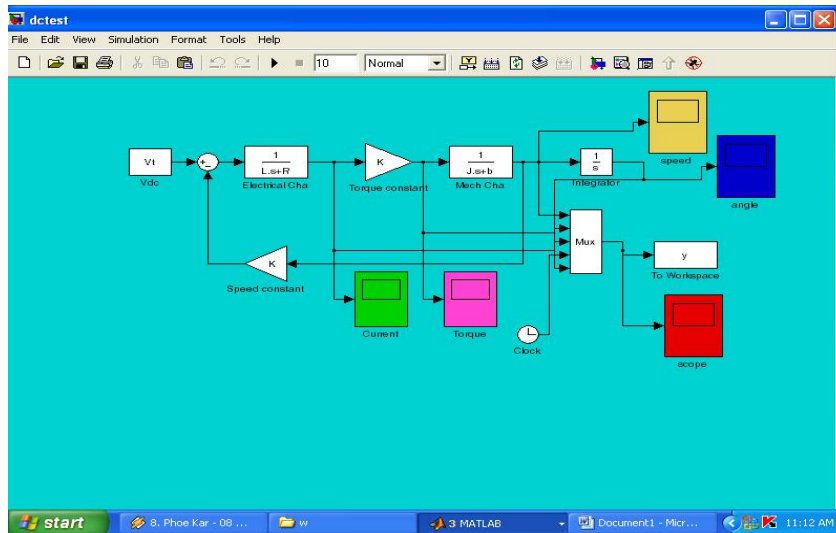

Fig. 4 Model that created in SIMULINK Toolbox of MATLAB

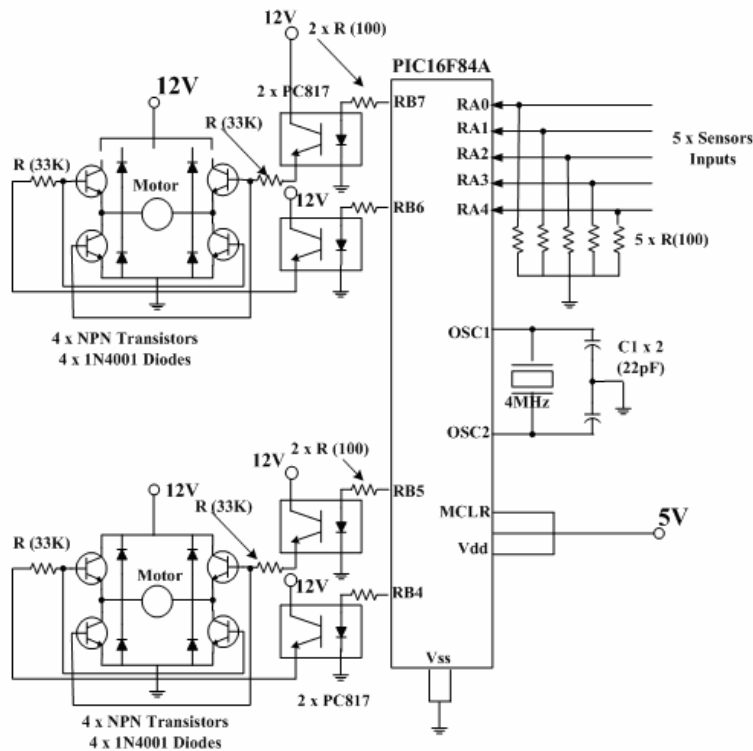

Fig. 5 PIC-based DC Motor Control System for WMR

B. Circuit Explanation of DC Motor Drive Circuit

The inputs of this circuit shown in Fig. 5 are the obstacle detected sensor outputs. It is assumed to be five sensors application, Front sensor, two Left sensors and two Right sensors. These sensors' outputs are inputted to the PIC16F84A at Port A: RA4-RA0. Depend on the inputs state, the outputs conditions that controlled the H-bridge circuit are

provided by assembly software, at Port B: RB7-RB4. As for PIC microcontroller, this part is supplied with 5V_{DC}. In this circuit, PIC is used with a simple clock condition with 4 MHz crystal.

The H-bridge circuit is supplied with 12V_{DC} and the four bits outputs of PIC made this part to drive the desire conditions of DC Motor. Opto-coupler circuit is used to feed

its output to the two transistors which will active one for each time. There are two H-bridge circuits to drive to motors and one part depends on two bits of PIC16F84A. Both circuits can be derived the Motors to be rotate only in '10' or '01' of these two bits. '00' and '11' means stopping Motor. Four NPN transistors are used as switch to change or choose the direction of current flows to the Motor.

V. EXPERIMENTAL RESULTS

The experimental results of both the Modeling and Simulink procedures and the control system testing circuit are shown in Fig. 6 to Fig. 12.

For the assembly software programming of the control circuit, the process is very simply and the procedure can be mentioned as the following steps.

Initialization

Ports Declaration: all Port A's pins are declared as inputs, four MSB Port B pins are declared as outputs.

Start program:

- check RA4(MSB) high or low
- check RA3 high or low
- check RA2 high or low
- check RA1 high or low
- check RA0 high or low

4. Determined outputs:

- If all inputs data are low outputs RB7-RB4, "1010" for freely going forward.
- If one or both of right sensors RA0 and RA1 are high, (A) check if any other sensor is high, outputs "1111" to stop. (B) if no other sensor is high, outputs "1000" to go left. If one or both of left sensors RA3 and RA4 are high, (A) check if any other sensor is high, outputs "1111" to stop. (B) if no other sensor is high, outputs "0010" to go right.

5. Special data: if RA2 is high, it mentioned that the obstacle is at the front of WMR and therefore, with any conditions of other inputs, it must be outputted "1111" to stop.

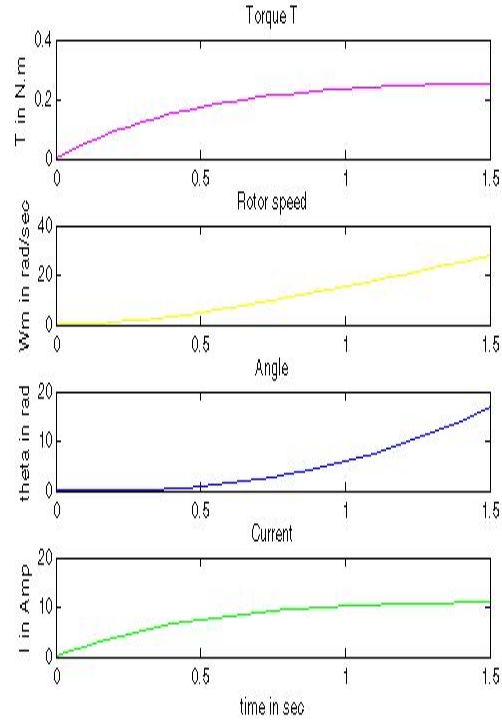

Fig. 6 Final result of M-file using 'dctest.mdl'

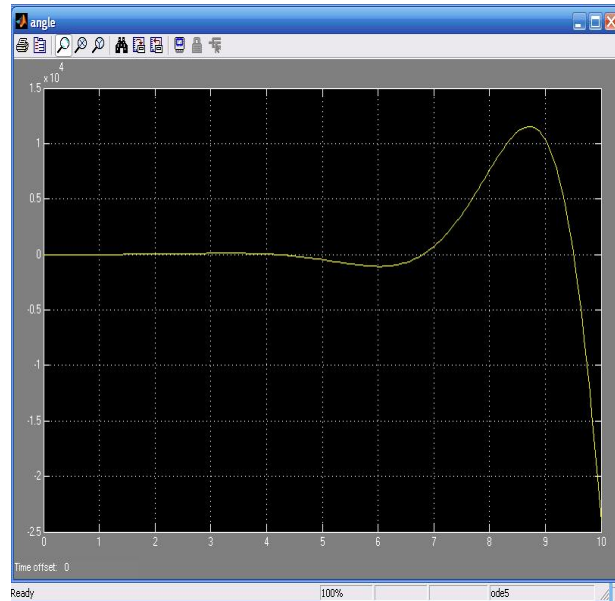

Fig. 7 Angle output from Simulink Model

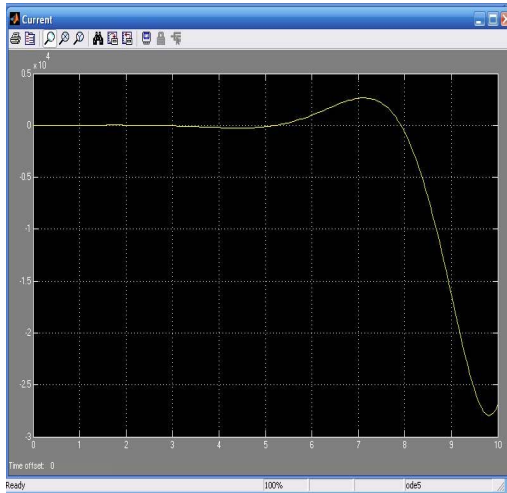

Fig. 8 Current output

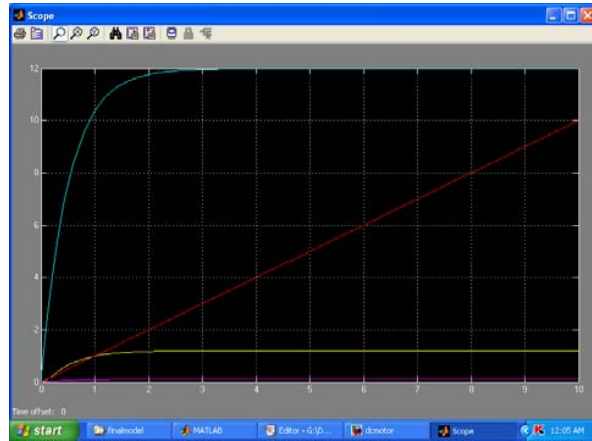

Fig. 11 Scope Output of all Ratings

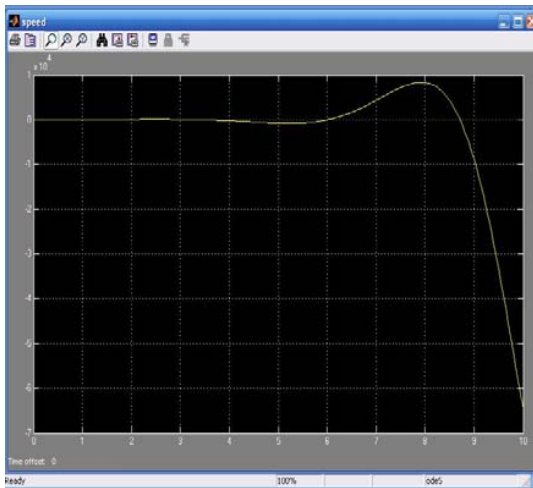
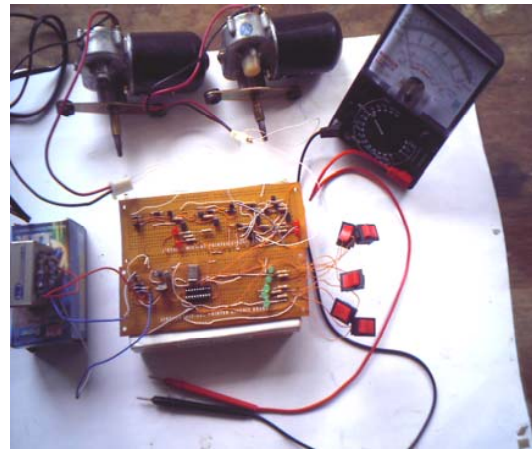

Fig. 9 Speed Output



(a)

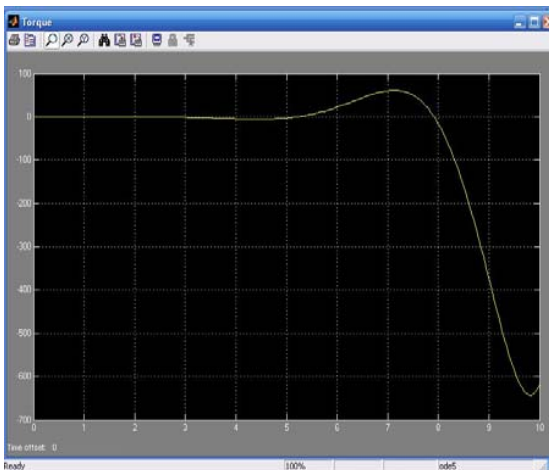
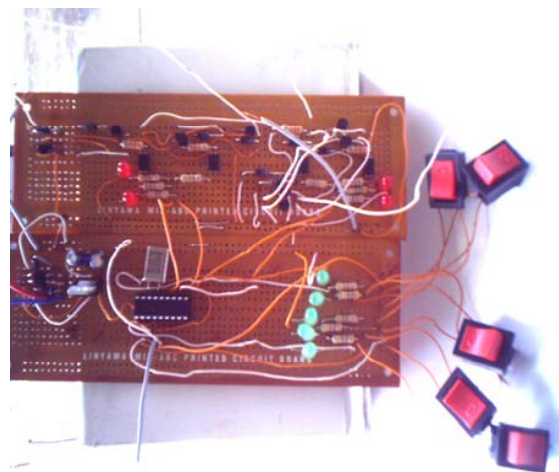
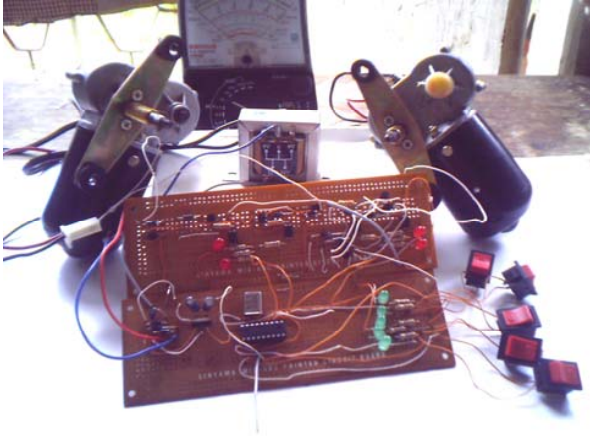

Fig. 10 Torque output



(b)



(c)

Fig. 12 Circuit Construction and Testing Photos

VI. CONCLUSION AND FURTHER EXTENSIONS

Electric machines are used to generate electrical power in power plants and provide mechanical work in industries. The DC machine is considered to be basic electric machines. The aim of this paper is to introduce Technicians to the modeling of power components and to use computer simulation as a tool for conducting transient and control studies. Next to having an actual system to experiment on, simulation is often chosen by engineers to study transient and control performance or to test conceptual designs.

MATLAB/SIMULINK is used because of the short learning curve that most students require to start using it, its wide distribution, and its general-purpose nature. This will demonstrate the advantages of using MATLAB for analyzing power system steady state behavior and its capabilities for simulating transients in power systems and power electronics, including control system dynamic behavior.

This paper mentioned only a part of the author's research and approaching of his studies in MATLAB software. The real application of this research paper is Robotic Control as mentioned in above. Therefore future extensions of this paper are based on Sensor Technology, Microcontroller Technology, Motion Control and Optimization of Simulink model using MATLAB. Optimizing of Model in MATLAB can be performed by using PID controller technique which can be analyzed in this MATLAB Simulink.

ACKNOWLEDGMENT

Firstly the author would like to thank his parents: U Hla WIN and Daw Saw Shwe for their best wishes to join the PhD research. Special thanks are due to his Supervisor/ Head of Electronic Engineering Department, MTU, Myanmar: Dr. Yin Mon Myint. The author would like to express his thank to his partners: Ms. Aye Aye New and Ms. Aye Aye Zan. The author greatly expresses his thanks to all persons whom will concern to support in preparing this paper.

REFERENCES

- [1] Steven T.Karris, 'Introduction to Simulink with Engineering Applications', Orchard Publications, www.orchardpublications.com
- [2] Tan Kiong Howe, May 2003, Thesis, B.E (Hons), 'Evaluation of the transient response of a DC motor using MATLAB/SIMULINK', University of Queensland.
- [3] MathWorks, 2001, Introduction to MATLAB, the MathWorks, Inc.
- [4] MathWorks, 2001, SIMULINK, the MathWorks, Inc.
- [5] MathWorks, 2001, What is SIMULINK, the MathWorks, Inc.
- [6] EE505 Electrical Engineering Lab, Spring 2007, project paper, 'Lab2. DC Motor Control using a Microcontroller'.
- [7] Carnegie,D.etal, 2004, 'A human-like Semi Autonomous Mobile Security robot, University of Waikato, Hamilton, New Zealand.
- [8] Microchip Technology, Inc.2001, PIC16F84A Data Sheet, www.microchip.com

Wai Phyo Aung was born in 1981, August 15. Got A.GTI Certificate in 2000, November. Graduated in 3rd November, 2003 with B.E (Electronic) and finished Master degree on March, 2006 with M.E (Electronic). Now, he is a PhD Candidate of Electronic Engineering Department, MTU, Myanmar.

He served as a Demonstrator at Mandalay GTC from May, 2002 to January, 2004 when he was attending the Special Engineering Course in MTU. From February, 2004 to now, he promoted as an Assistant Lecturer of Dawei Technological University, Department of Technical and Vocational Education, Myanmar. For his Master Thesis, he wrote the results of his research "Design and Construction of PIC-based Frequency Counter". Now, he is making his PhD research at Mandalay Technological University (MTU), Myanmar with the title of "Design and Construction of Motor Drive System used for mobile Industrial Robot".

Mr. Wai Phyo Aung made his first publication of International Paper at this paper "Analysis on Modeling and Simulink of DC Motor and Its Driving System used for Wheeled Mobile Robot".