

A New Load Frequency Controller based on Parallel Fuzzy PI with Conventional PD (FPI-PD)

Aqeel S. Jaber, Abu Zaharin Ahmad, and Ahmed N. Abdalla

Abstract—The artificial intelligent controller in power system plays as most important rule for many applications such as system operation and its control specially Load Frequency Controller (LFC). The main objective of LFC is to keep the frequency and tie-line power close to their decidable bounds in case of disturbance. In this paper, parallel fuzzy PI adaptive with conventional PD technique for Load Frequency Control system was proposed. PSO optimization method used to optimize both of scale fuzzy PI and tuning of PD. Two equal interconnected power system areas were used as a test system. Simulation results show the effectiveness of the proposed controller compared with different PID and classical fuzzy PI controllers in terms of speed response and damping frequency.

Keywords—Load frequency control, PSO, fuzzy control.

I. INTRODUCTION

ONE of the major subjects in electrical interconnected power system is the load frequency control (LFC) which the net power flow on tie-lines is decided on a priori contract basis [1]. Therefore it is important to have a good of control over the net power flow on the tie-lines. The main objective of LFC is keeping the frequency and tie-line power close to their decidable bounds in case of disturbance such as in the case of the generating unit is suddenly disconnected by the protection equipment and also for the large load that is suddenly connected or disconnected. Many LFC strategies have been developed and proposed, but most of them depending on the linear or non-linear control methods [2]. In order to control the frequency in power systems, various controllers have been are used in different areas, but due to the non-linearity in system components and alternators, these developed feedback controllers could not efficiently control the frequency and rather slow for output response. The conventional controller such as PID control schemes will not reach a good performance [3] because the dynamics of a power system is inherently nonlinear, time invariant and governed by strong cross-couplings of the input variables. Therefore, the controllers have to be designed with taking into account the nonlinearities and disturbances.

Aqeel S. Jaber is with Faculty of Electrical and Electronic Engineering, University Malaysia Pahang, Pekan 26600, Malaysia (e-mail: aqe77el@yahoo.com).

Abu Zaharin Ahmad is with Sustainable Energy & Power Electronics Research (SuPER) group in Faculty of Electrical and Electronic Engineering, University Malaysia Pahang, Pekan 26600, Malaysia (e-mail: zaharin@ump.edu.my).

Ahmed N. Abdalla is with Sustainable Energy & Power Electronics Research (SuPER) group in Faculty of Electrical and Electronic Engineering, University Malaysia Pahang, Pekan 26600, Malaysia.

Static Output Feedback gains and Linear Matrix Inequality are the most effective and efficient tool in control design, which stabilizes the system which used to calculate the gains of PID controller gains [4]. The Robust adaptive control schemes also have been developed to deal the changes in system parametric [5]. An intelligent controller such as PID-ANN, PI-fuzzy and optimal control applied to LFC have been reported in [6]. Using genetic algorithm to scale of PI fuzzy controller in LFC has been reported in [7].

In this paper, a combination of adaptive fuzzy-PI with conventional PD technique for Load Frequency Control system was proposed. In most of literature research the Fuzzy-PI is more oscillation than the conventional PID controller and fuzzy membership shapes and control rules are select depending on system experts' experience [11]. This means there no rule will be fire for input membership in unexpected conditions, which means LF will not be considered. The adaptive between the classical fuzzy-PI controller and conventional PD controller solve these problems. The simulation results are carried out in term frequency response on its damping under different load conditions and compared it to the effectiveness of proposed controllers with conventional PID controller and classical fuzzy controller. Simulation results show that the oscillation, peak under shot and settling time with the proposed controller are better and guarantees robust performance under a wide range of operating conditions.

II. THEORETICAL BACKGROUND

Power systems have complex and multi-variable structures. Also, they consist of many different control blocks. Most of them are nonlinear and/or non-minimum phase systems [6]. Power systems are divided into control areas connected by tie lines. All generators are supposed to constitute a coherent group in each control area.

A. Load Frequency Control (LFC)

Small changes in real power are mainly dependent on changes in rotor angle δ_r and, thus, the frequency f . The aim of LFC is to maintain real power balance in the system by controlling the frequency. When the real power demand changes, a frequency also will change and in same way the change in load angle δ_r is caused by momentary change in generator speed. Therefore, LFC is non-interactive for small changes and can be modelled and analyzed. This frequency error is amplified, mixed and changed to a command signal which is sent to turbine governor. The governor operates to restore for balancing the power between the input and output by

changing the turbine output. This method is also referred as Megawatt frequency or Power-frequency (P-f) control [7].

B. PID Controller

PID control law has been well adopting in digital PID control algorithm [8]. Digital PID control law comes from the discretization of analogue PID control law as in the following:

$$u(k) = K_p + K_I \sum_{j=0}^k e(j) + K_D[e(k) - e(k-1)] \quad (1)$$

where, K_p is proportional coefficient, K_I is integral coefficient, K_D is differential coefficient, $u(k)$ is the output control volume in the k -sampling time, $e(k)$ is the input deviation in the k -sampling time, $e(k-1)$ is the input deviation in the $(k-1)$ -sampling time.

Because of each output $u(k)$ value directly is corresponding with the location of actuator, so (1) is called location-based PID algorithm. Using this algorithm, each output is related with the past states and $e(k)$ need be accumulated. So, the calculation is not only trivial, but also it can be seen, due to the general computer control system adopting constant.

C. Fuzzy Logic

Nowadays fuzzy logic is used in mostly sectors of industry and load-frequency control [9]. The main goal of load-frequency control in interconnected power systems is to protect the balance between production and consumption. Because of the complexity and multi-variable conditions of the power system, conventional control methods may not give satisfactory solutions.

According to many researchers, there are some reasons for the present popularity of fuzzy logic control. First of all, fuzzy logic can be easily applied for most applications in industry. Besides, it can deal with intrinsic uncertainties by changing the controller parameters. On the other hand, their robustness and reliability make fuzzy controllers useful in solving a wide range of control problems [9]. The fuzzy controller for the single input, single output type of systems is shown in Fig. 1 [10]. Fuzzy logic shows experience and preference through its membership functions. These functions have different shapes depending on system experts' experience [11].

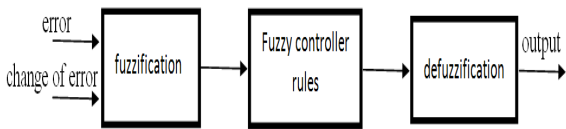

Fig. 1 Fuzzy controller block diagram

D. PSO Algorithm

PSO was introduced by Eberhart and Kennedy as a new heuristic method [12]. PSO was inspired by the food-searching behaviours of fish and their activities or a flock of birds. In D-dimensional search space. The best individual position of particle i and the best position of the entire swarm are represented by

$$v_i(t + 1) = \omega v_i(t) + c_1 r_1 (p_i(t) - X_i(t)) + c_2 r_2 (G(t) - X_i(t)) \quad (2)$$

$$X_i(t + 1) = X_i(t) + v_i(t + 1) \quad (3)$$

where:-

$P_i = (p_i1, p_i2, \dots, p_iD)$ and $G = (g1, g2, \dots, gD)$, respectively, ω is inertia weight parameter and $c1, c2$ is acceleration coefficients.

In each iteration of the PSO algorithm, the particles use the following equations to update their position (x_i) velocity (v_i) [12].

E. Two Area LFC Model

The net power (ΔP) due to disturbance (ΔP_D) is when the change in power generation. Where the ΔP_G is described as

$$\Delta P = \Delta P_G - \Delta P_D \quad (4)$$

This change will absorbed by changing in kinetic energy (W_{kin}) of mass and load consumption and export of power (ΔP_{tie}) so ΔP for i_{th} area is as follows;

$$\Delta P = 2 \frac{W_{kin}}{f} \frac{\partial}{\partial t} (\Delta f) + D_i \Delta f_i + \Delta P_{tiei} \quad (5)$$

where, D is power regulation and equal to $\Delta P / \Delta f$.

By taking Laplace transformation

$$[\Delta P_{Gi}(s) - \Delta P_{Di}(s) - \Delta P_{tiei}(s)] \frac{K_{Pi}}{1 + sT_{Pi}} = \Delta F_i(s) \quad (6)$$

where, $T_{Pi} = \frac{2H_i}{fD_i}$ sec, (H) is inertia constant and (f) is the frequency. If the line losses are neglected, the individual ΔP_{tieij} can be written as

$$P_{tieij} = \frac{|v_i||v_j|}{x_{ij}P_{ri}} \sin(\delta_i - \delta_j) \quad (7)$$

The phase angle changes are related to the area frequency changes by

$$\Delta \delta_i = 2\pi \int \Delta f_i dt \quad (8)$$

So, the power obtained as follows

$$P_{tieij} = T_{ij} \int \Delta f_i dt - \int \Delta f_j dt \quad (9)$$

where, $P_{tie} = 2\pi \frac{|V_i||V_j|}{X_{ij}P_{ri}} \cos(\delta_i - \delta_j)$ and δ is load angle

Upon Laplace transforming (8), one gets

$$\Delta P_{tieij}(s) = \frac{T_{ij}}{s} [\Delta F_i(s) - \Delta F_v(s)] \tag{10}$$

The transfer of generator turbine (G_{gf}) is written by

$$G_{tf} = \frac{1}{(1+sT_{Gi})(1+sT_{Ti})} \tag{11}$$

where, T_T are turbine time constant and T_G speed governor time constant.

The parameters in Fig. 2 are defined as follows:

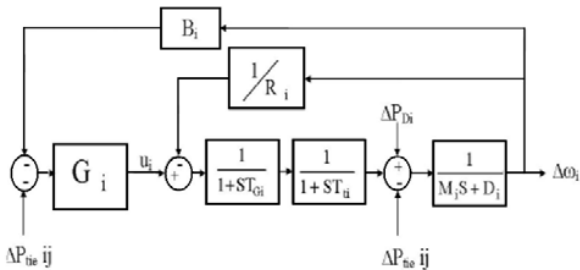

Fig. 2 Block diagram for system of one area

The constant R_i measured in Hz/pu MW is a measure of the static speed droop of the uncontrolled turbine generator and $B_i = D + 1/R_i$. So the block diagram of single area for multi interconnected power system areas is shown in Fig. 3.

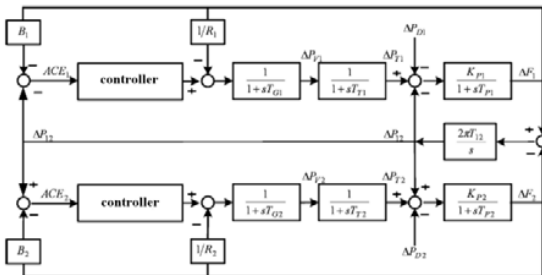

Fig. 3 Block diagram for system area of multi areas power system

III. PROPOSED METHOD

The boundaries of the membership functions that are adjusted based on expert in the Fuzzy methods, person's experiences may do not guarantee the systems' performance, and it might be have anorule inference will be fire for input membership of the fuzzy controller in some unexpectable cases. The addition of PD to fuzzy PI will guarantee that all of

the conditions are under control. The value of PD that shown in Fig. 4, is define do veran uncertain range and then will be obtained by PSO algorithms.

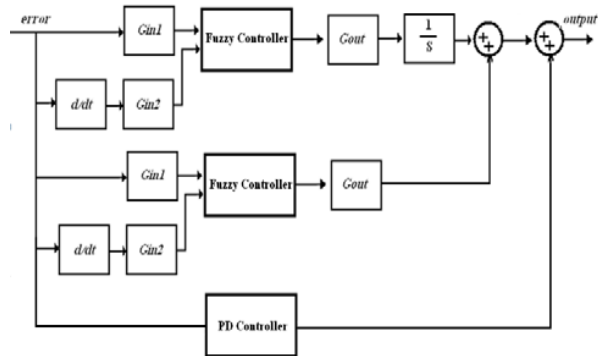

Fig. 4 Proposed controller

The flow chart of PSO algorithm to optimize the scaled fuzzy parameters is shown in Fig. 5.

The rules of fuzzy controller which used in this paper are listed in Table I, the membership function sets for the input and the output of fuzzy controller are shown in Fig. 6. In this controller, the method of defuzzification has been performed by the center of gravity.

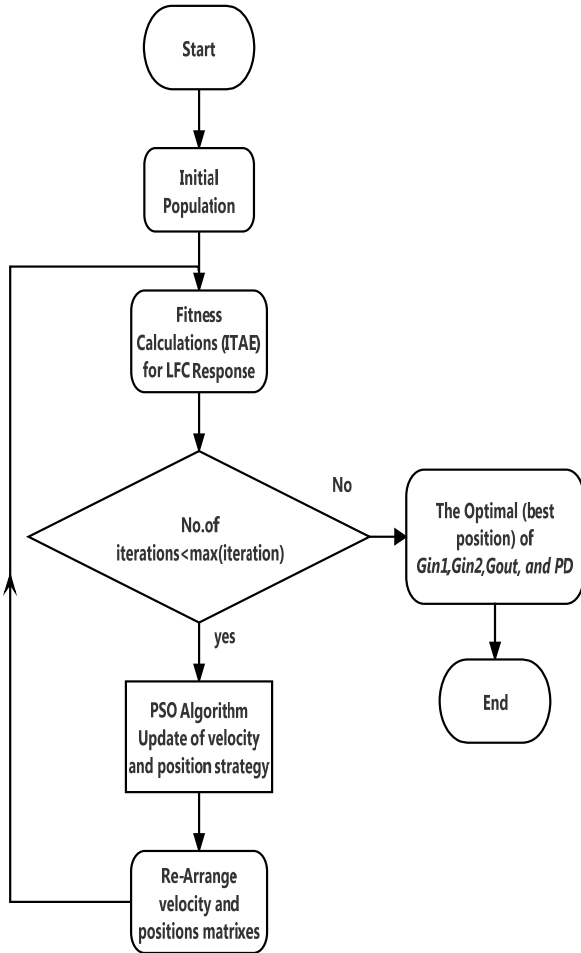

Fig. 5 Optimizing fuzzy parameter and PD using PSO

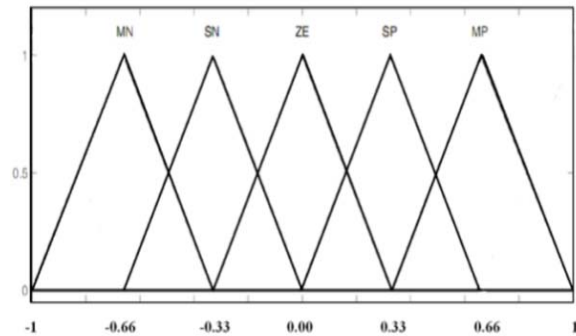

Fig. 6 Membership function for input& output offuzzy controller

TABLE I
FUZZY CONTROLLER RULES

$e/\Delta e$	MN	SN	Z	SP	MP
MN	MN	MN	NS	NS	Z
SN	MN	NS	NS	Z	Z
Z	NS	NS	Z	Z	SP
Sp	NS	Z	Z	SP	SP
MP	Z	Z	SP	SP	MP

where: MN is medium negative, SN is small negative, Z is zero, SP is small positive, and MP is medium positive.

IV. RESULTS AND DISCUSSION

The simulation was done using the MATLAB 7.1 in order to investigate the effectiveness of the proposed method on system performance. The system parameter is shown in the Table II.

TABLE II
DATA OF SYSTEM

R1=R2	$T_{G1}=T_{G2}$	$T_{T1}=T_{T1}$	$T_{P1}=T_{P2}$	$K_{P1}=K_{P2}$	T12	$B_1=B_2$
2.4	0.08	0.28	18	120	0.08	0.425

The gains are setting the range as in the following; $0.01 < G_{in1} < 10$, $0.01 < G_{in2} < 10$, $0.01 < G_{out} < 10$, and $0 < PD < 5$

Firstly to validate the effectiveness of addition of PD to the classical fuzzy controller multi values of PD was been added to the classical fuzzy controller as shown in Fig. 7.

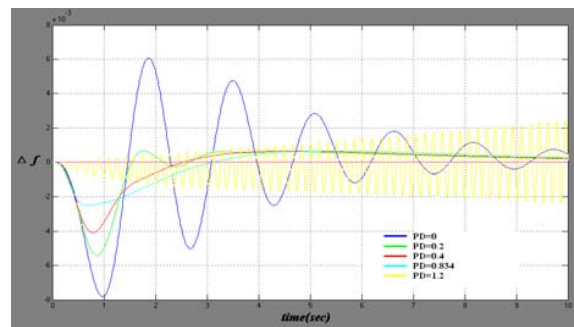

Fig. 7 The effectiveness of adding PD controller

The effectiveness of adding PD controller to the fuzzy control on the peak under shoot for 6% of load change can be shown in Table III.

TABLE III
EFFECTIVENESS OF ADDING PD CONTROLLER

PD value	0	0.2	0.4	0.834	1.2
P.U.S	0.0078	0.0054	0.0041	0.0025	Unstable

Where: P.U.S: Peak undershoot

In order to demonstrate the robustness performance of the proposed method based on ITAE, under step change in the different demands.

Secondly, the proposed controller was designed and compared with classical fuzzy and conventional PID controllers for LFC under system uncertainties (controller robustness), multi operation conditions as shown in Fig. 8, Fig. 9 and Fig. 10, respectively.

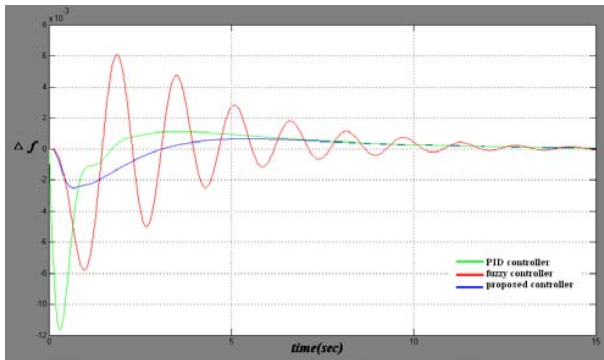

Fig. 8 Frequency deviations of 1% load change

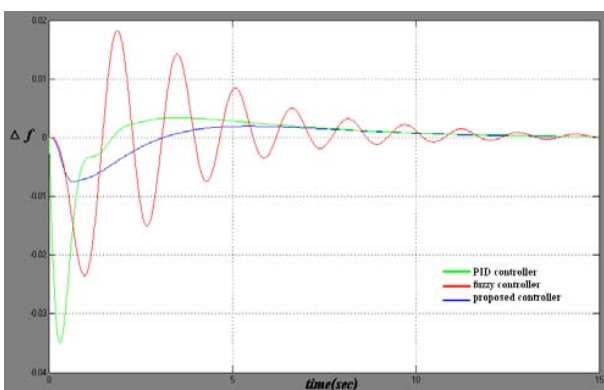

Fig. 9 Frequency deviations of 3% load change

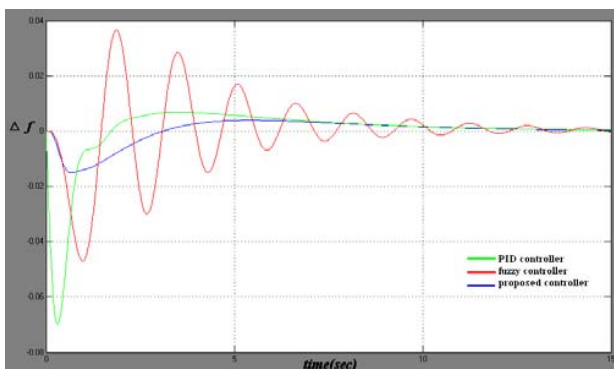

Fig. 10 Frequency deviations of 5% load change

Table IV shows for the frequency deviation of peak under shoot & and settling time for fuzzy-PI controller and conventional PID controller.

TABLE IV
COMPARISON OF FUZZY-PI CONTROLLER AND CONVENTIONAL PID CONTROLLER

L.Ch	PID controller		Classical fuzzy controller		Proposed controller	
	P.U.S	S.t (s)	P.U.S	S.t (s)	P.U.S	S.t (s)
	1	1.18	13.43	0.793	9.14	0.254
2	2.32	12.91	1.54	9.1	0.491	9.01
3	3.5	12.31	2.4	9.21	0.7	9.21
4	4.7	11.82	3.2	9.33	1.01	9.33
5	6.8	11.51	4.8	9.38	1.7	9.38

V. CONCLUSION

In this paper, a two-area power system studied and the errors of the linearization are considered as parametric uncertainties and un-modelled dynamics. Each area consists of three first-order transfer functions, modelling the turbine, governor and power system. In addition, all generators in each area are assumed to form a coherent group. These rules are obtained based on simulation of the process step response, error signal and its time derivative and based on these rules; a PI controller generates the control signal. The simulation results prove that the proposed controller has obtained fast response and less undershoots compared to PID controller and classical fuzzy controller.

REFERENCES

- [1] Y. Wang, R. Zhou, and C. Wen, "Robust load-frequency controller design for power systems," *Generation, Transmission and Distribution, IEE Proc. C.*, vol. 140, no. 1, 1993.
- [2] E. Çam and İ. Kocaarslan, "Load frequency control in two area power systems using fuzzy logic controller," *Energy Conversion and Management*, vol. 46, no. 2, pp. 233-243, Jan. 2005.
- [3] A. A. Ghany, "Design of Static Output Feedback PID controller via LMI method for a power system stabilizer," *Power System Conference, 2008. MEPCON*, pp: 593 -599, 2008.
- [4] A. Stankovic, "On robust control analysis and design for load frequency regulation," *IEEE Trans. On Power Systems*, vol. 13, no. 2, pp. 449 - 455, 1998.
- [5] K. Parmar, S. Majhi, and D. Kothari, "Multi-area load frequency control in a power system using optimal output feedback method," *PEDES& 2010 Int. Conf. Power India*, pp: 1 -5, 2010.
- [6] C. Chang and W. Fu, "Area load frequency control using fuzzy gain scheduling of PI controllers," *Electric Power Systems Research*, Vol. 2, Issues 2, pp: 145 -152, 1997.
- [7] S. Broujeni, S. Hemmati, and H. Fayazi, "Load frequency control in multi area electric power system using genetic scaled fuzzy logic," *Int. J. Phys. Sci.*, pp: 796 - 800, 2011.
- [8] J. Hertz, A. Krogh, and R. Palmer, *Introduction to the theory of neural computation*, MA Addison Wesley, 1991.
- [9] H. Saadat, *Power system analysis*. Mcgraw-Hill, 2005.
- [10] T. Yang W., Zhang R., Zhang C, "Research Of Realizing PID Controller Based On FPGA," *Microcomputer Information*, pp. 2-11, 2005.
- [11] K. A. El-Metwally, "An Adaptive Fuzzy Logic Controller for a Two Area Load Frequency Controller Problem" *IEEE, MEPCON 2008*, pp: 300 -306, 2008

- [12] J. Kennedy and R. Eberhart, "Particle swarm optimization," *Neural Networks, 1995. Proceedings*, pp. 2.2-1–2.2-6.