

Capacitive Air Bubble Detector Operated at Different Frequencies for Application in Hemodialysis

Mawahib Gafare Abdalrahman Ahmed, Abdallah Belal Adam, and John Ojur Dennis

Abstract—Air bubbles have been detected in human circulation of end-stage renal disease patients who are treated by hemodialysis. The consequence of air embolism, air bubbles, is under recognized and usually overlooked in daily practice. This paper shows results of a capacitor based detection method that capable of detecting the presence of air bubbles in the blood stream in different frequencies. The method is based on a parallel plates capacitor made of platinum with an area of 1.5 cm² and a distance between the two plates is 1cm. The dielectric material used in this capacitor is Dextran70 solution which mimics blood rheology. Simulations were carried out using RC circuit at two frequencies 30Hz and 3 kHz and results compared with experiments and theory. It is observed that by injecting air bubbles of different diameters into the device, there were significant changes in the capacitance of the capacitor. Furthermore, it is observed that the output voltage from the circuit increased with increasing air bubble diameter. These results demonstrate the feasibility of this approach in improving air bubble detection in Hemodialysis.

Keywords—Air bubbles, Hemodialysis, Capacitor, Dextran70, Air bubbles diameters.

I. INTRODUCTION

AIR bubbles usually originate within the extracorporeal tubing and are carried with the solution flowing into the blood stream [1]. The bubbles may be present in hemodialysis (HD) while priming and preparing the lines for use, or newly formed as a result of turbulent flow of the fluids in the tubing and the vascular access. The bubbles' fate in the drip chamber designed to be a mechanical safety component of an extracorporeal infusion set is affected by many factors, most importantly their size and the fluid flow rate.

As far as 1975, there was evidence for pulmonary microembolization during HD [2]. At that time researchers found increased screen filtration resistance in the HD system and attributed it to fibrin deposits and blood clots filling the filter. The subject of dialysis induced air emboli was revisited recently, mainly as a consequence of improved detection technology facilitating investigation of the nature of air emboli.

Different physical principles have been employed in air bubbles detection. The earliest air bubbles detectors consisted of a light source which triggered a photocell situated on the opposite side of the bubble trap; the cell did not react if blood obstructed the light path [3]. These devices were insensitive to foam and could not react if fibrin deposits on the inner wall of

the bubble trap obstructed the light path. In addition, ambient light could reach the photocell and cause false alarms. Infrared light photocell devices have increased the sensitivity to air bubbles detection but are still not foolproof against obstruction to the passage of the infrared waves, or sensitive enough to be reliable against foam without causing multiple false alarms. Furthermore, it is only capable of detecting the presence of macroscopic air emboli of 1 mm diameter or larger.

Another method used is electrical impedance measurement devices. In this method, a tank with linear array of four electrodes spaced approximately 1 cm apart down one side was filled with 0.2 S/m of saline. Bubbles were generated by carbon dioxide gas. Electrical transfer impedance was measured every 8.2 ms at 1.25 MHz. The movement of bubbles was recorded by a video camera, and their sizes and depths from the middle of the array were measured using captured video images. Using the Lead Filed Theory and experimental results, the fundamental limit on the detectable size of bubbles was estimated at the carotid artery. The theoretical results showed that a 0.5 mm diameter bubble was detectable at a depth of 5.3 mm, and a 2.3 mm diameter bubble was detectable at a depth of 21 mm [4].

Finally, an ultrasonic device is also utilized to detect air bubbles in artificial kidney. This device is based on the principle of the transmission of ultrasonic waves across the bubble trap [5]. The problem with this approach is that ultrasound is expensive and is neither able to accurately evaluate the size of individual bubbles, nor detect them as individual bubbles when they are close together. Also, ultrasound measures discontinuities in the bloodstream and therefore cannot distinguish between micro air and tiny blood clots and the accuracy of ultrasound measurements becomes poor for small diameter bubbles. Furthermore, in pulsing ultrasound applications, the propagation velocity of sound requires ultrasound pulses to be at least 10-20 μ sec apart for a fast-moving 1.25 cm diameter bloodstream, so that tracking is not continuous.

Consequently, a more accurate and discriminating method of detecting micro air was needed [5]. The present work is a study on the proposed use of a capacitor based device to detect air bubbles in the blood stream in the range from 620 μ m to 4.1mm.

II. METHODOLOGY AND MATERIALS

The methodology for this project consists of three main parts; the first part is simulation then theoretical and the last part is experimental work.

A. Simulation

Multisim2001 software is used to examine the change in output voltage when there is a change in the capacitance of a capacitor at two different frequencies 30 Hz and 30 kHz. The capacitor is placed in a circuit and the output voltage is measured across it using a low pass filter circuit as part of a detection unit. Fig. 1 show the detection unit connected to the amplification unit. The signal conditioning unit and the output unit are not shown here. The value of the capacitance of the capacitor is theoretically calculated using equation 1.

$$C = \frac{\epsilon_0 \epsilon_r A}{d} \quad (1)$$

Where ϵ_0 is the permittivity of free space, ϵ_r is the dielectric constant of the Dextran fluid, A is the area of the two plates and d the distance between the two plates [6].

B. Mathematical Derivation

The mathematical expression which is used to get the theoretical result is:

$$V_{C_{Peak}} = \frac{V_{in}}{\sqrt{1 + (2\pi fRC)^2}} \quad (2)$$

Where $V_{C_{Peak}}$: is the maximum output voltage from the capacitor, V_{in} : is the input voltage from the signal generator, f : is the frequency applied in the circuit, R : is the resistance of the resistor and C : is capacitance of the capacitor [7].

Then $V_{r.m.s}$ is theoretical calculated to compare it with simulation and experimental results.

C. Experimental set-up

In fabricating the detector cell, two plates of platinum of area 1.5 cm^2 are encased within an acrylic material to form a capacitor into which the Dextran70 fluid would be introduced. The setup for the capacitor detector cell is shown in Fig. 2. The distance between the two platinum plates is nominally fixed at 1.0 cm and electric lead wires is attached to the plates to measure the changes in the capacitor parameters when the Dextran70 solution is introduced between the plates.

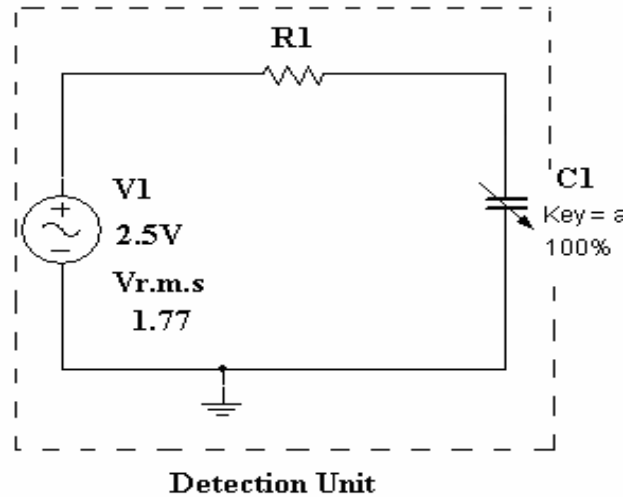

Fig. 1 Analog circuit of the proposed system

The Dextran70 solution used in the tubing system is a mixture of isotonic water with 9g NaCl and 40g/ L dextran70 with 50 mL of a 20% concentration of an albumin solution [8]. This composition selected for the fluid mixture has been shown to closely mimic blood rheology. The viscosity of the solution was 3.41 mPa.s at $T=37.1^\circ\text{C}$

In carrying out the experiment, the Dextran70 solution prepared is introduced in between the capacitor plates through inlet and outlet tubes with valves attached at their ends. Then 30 Hz is applied to the circuit and the data is recorded and after that 3 kHz is applied.

The tubes are first opened to allow the solution to move in between the capacitor plates and then closed to keep the liquid in place. The output voltage is then measured via the lead wires connected to the capacitor plates as an air bubble of a given diameter was introduced in the Dextran70 solution contained between the capacitor plates. Air bubbles with different diameters were used in order to investigate the change in capacitance as a function of the bubble diameter. The diameter of air bubbles used range from $620 \mu\text{m}$ to 4.1 mm.

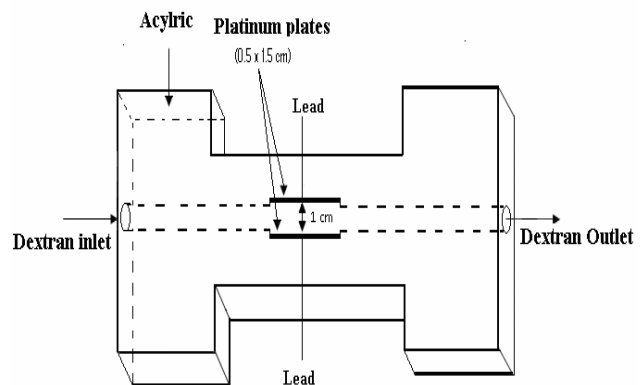

Fig. 2 Schematic diagram of the capacitive detector device

III. RESULTS AND DISCUSSION

From simulation when a frequency 30 Hz applied, the voltage at the output of the capacitor is decreased with increasing the capacitance of the capacitor as shown in Fig. 3. The linearity of a graph is defined as the measurement of how far the output varies from a straight line. From the simulation result and theory the linearity error was determined to be about 0.1%. From the graph it is clear that simulation and theoretical results shows close agreement.

In the experimental work, the Dextran70 solution without air bubbles was allowed between the plates of the capacitor and the output voltage determined. Air bubbles of various diameters were then singly introduced into the Dextran70 solution between the plates of the capacitor and the output voltage measured and recorded in each case. Fig. 3 shows the experimental variation in the output voltage as a function of the capacitance. From the experimental result the linearity error was determined to be about 2.8%

From Fig. 4 it is clear that the capacitance of the capacitor decreases as the air bubbles diameter increased; linearly from a value of 43.5 nF to about 39.1 nF with a linearity error of 3.5%.

Fig. 5 shows the graph of the experimental output voltage as a function of the diameter of the air bubbles. It is observed that as the diameter of the air bubble injected into the Dextran70 solution between the plates increases from zero (for no air bubble in the solution) to 4.1 mm, the output voltage increases approximately linearly from a voltage of 1.208 V to 1.259 V with a linearity error of about 2.2 %.

At 3 kHz the voltage at the output of the capacitor is decreased with increasing the capacitance of the capacitor as shown in Fig. 6. The linearity error from simulation and theory it remained the same as 30 Hz is applied but the linearity error from experimental work is 1.4%.

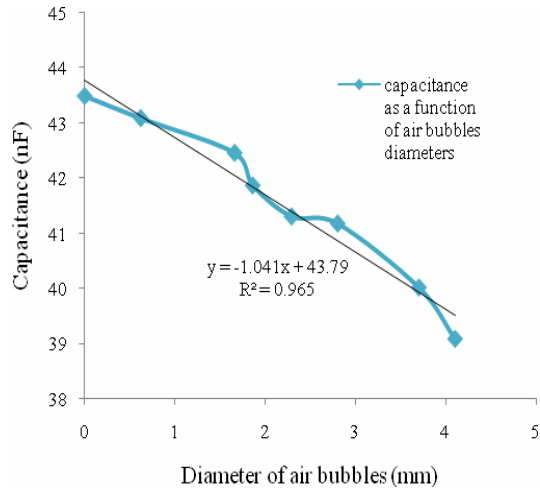

Fig. 4 Capacitance versus diameter of air bubbles at 30 Hz

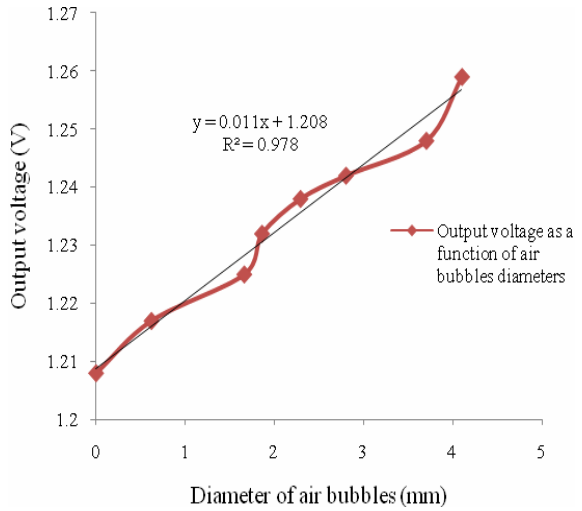

Fig. 5 Output voltage versus air bubbles diameter at 30 Hz

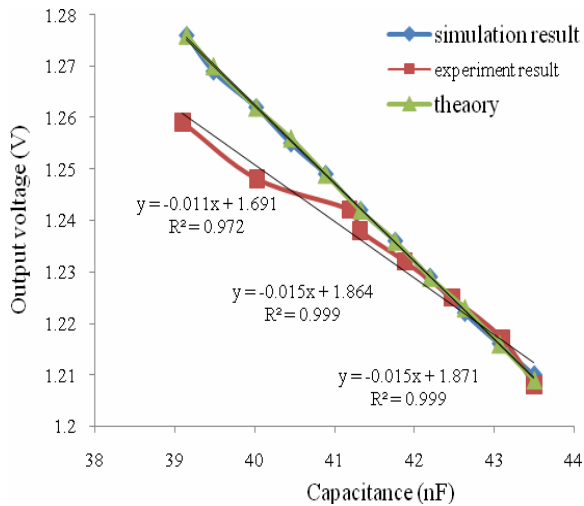

Fig. 3 Output voltage versus capacitance at 30 Hz

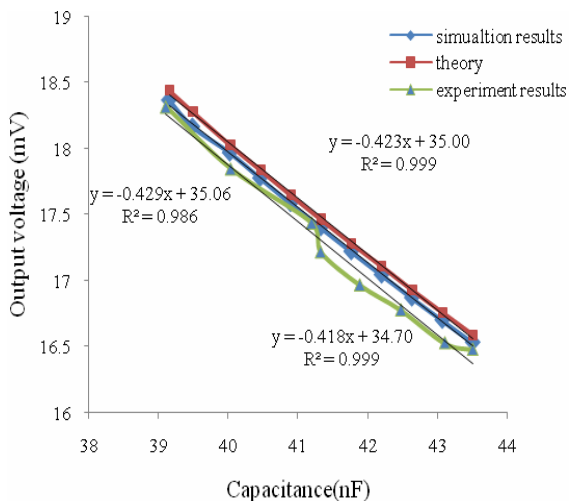

Fig. 6 Output voltage versus capacitance at 3 kHz

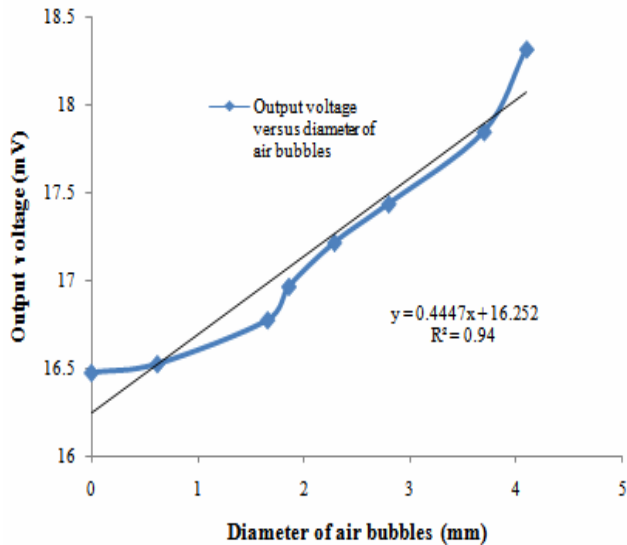

Fig. 7 Output voltage versus air bubbles diameter at 3 kHz

Fig. 7 shows the graph of the experimental output voltage as a function of the diameter of the air bubbles at 3 kHz. It is observed that as the diameter of the air bubble injected into the Dextran70 solution between the two plates increases from zero to 4.1 mm, the output voltage increases approximately linearly from a voltage of 16.48 mV to 18.32 mV with a linearity error of about 6 %.

Fig. 8 shows that the capacitance of the capacitor decreases as the air bubbles diameter increased; linearly from a value of 43.5 nF to about 39.1 nF with a linearity error of 3.5%.

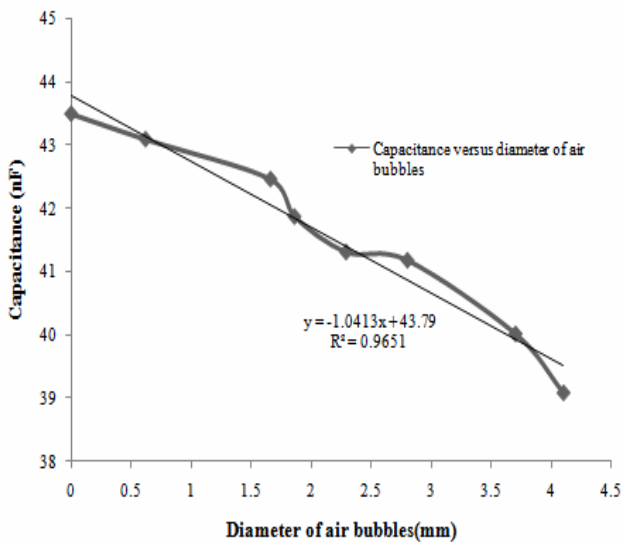

Fig. 8 Capacitance of the capacitor versus air bubbles diameter at 3 kHz

IV. CONCLUSION

This study indicated that by injecting a single air bubble of different diameters (from 620 μm to 4.1 mm) into the Dextran solution between the plates of a capacitor device, a significant change in the capacitance of the capacitor is observed. The experimental results had a good agreement with simulation results and theory at the frequency 30 Hz and 3 kHz. The sensitivity of the device at 30 HZ was found to be 11 mV/nF and at 3 kHz is 0.4 mV/nF. The main advantages of this device are its reliability, cost effectiveness and the capability of integration with simple electronics and signal conditioning circuit.

ACKNOWLEDGMENT

The authors would like to thank Ipoh Specialist Hospital and the Departments of Chemical Engineering and Mechanical Engineering in Universiti Teknologi PETRONAS (UTP) for offering their facilities and assistance for conducting the research. Our gratitude is also extended to all the technicians in the Department of Electrical and Electronics Engineering (UTP) for their support.

REFERENCES

- [1] Michal Barak, Farid Nakhoul, and Yeshayahu Katz. Pathophysiology and Clinical Implications of Micro Bubbles during Hemodialysis. *Seminars in Dialysis*. 2008; 21: 232-238.
- [2] Bischel MD, Scoles BG, Mohler JG. Evidence for Pulmonary Microembolization during hemodialysis. *Chest*. 1975; 67: 335-337.
- [3] Vivian WA, Malloy KP, Hackett JE, et al. Clinical evaluation of an air embolism detection device. *Cardiovasc Dis* 1980; 7:425-428.
- [4] Nebuya S, Noshiro M, Brown BH, et al. Estimation of the size of air emboli detectable by electrical impedance measurement. *Med Biol Eng Comput* 2004; 42:142-144.
- [5] Markus H. Transcranial Doppler detection of circulating cerebral emboli: a review. *Stroke* 1993; 24:1246-1250.
- [6] Giorgio Rizzoni (2000), Principles and Applications of Electrical Engineering McGraw-Hill Higher Education.
- [7] Robert L. Boylestad and Louis Nashelsky(2006), Electronic Devices and Circuit Theory. Ninth Edition.
- [8] Christorfer J. Stegmayr, Per Jonsson, Ulf Forsberg and Bernd G. Stegmayr (2007), Development of Air Micro Bubbles in the Venous Outlet Line: an in Vitro Analysis of Various Air Traps Used for Hemodialysis. *Journal of Artif Organs*, 31, 483-488.