

Spread Spectrum Image Watermarking for Secured Multimedia Data Communication

Tirtha S. Das, Ayan K. Sau, and Subir K. Sarkar

Abstract—Digital watermarking is a way to provide the facility of secure multimedia data communication besides its copyright protection approach. The Spread Spectrum modulation principle is widely used in digital watermarking to satisfy the robustness of multimedia signals against various signal-processing operations. Several SS watermarking algorithms have been proposed for multimedia signals but very few works have discussed on the issues responsible for secure data communication and its robustness improvement. The current paper has critically analyzed few such factors namely properties of spreading codes, proper signal decomposition suitable for data embedding, security provided by the key, successive bit cancellation method applied at decoder which have greater impact on the detection reliability, secure communication of significant signal under camouflage of insignificant signals etc. Based on the analysis, robust SS watermarking scheme for secure data communication is proposed in wavelet domain and improvement in secure communication and robustness performance is reported through experimental results. The reported result also shows improvement in visual and statistical invisibility of the hidden data.

Keywords—Spread spectrum modulation, spreading code, signal decomposition, security, successive bit cancellation

I. INTRODUCTION

DIGITAL watermarking algorithms can be thought as digital communication scheme where an auxiliary message is embedded in digital multimedia signals and are available where ever the latter signals move. The decoded message latter on serves the purpose of security in communication, copyright protection, data authentication, broadcast monitoring etc. Robustness is an essential criterion in digital multimedia watermarking schemes along with visual transparency, high data embedding rate, low computation cost and complexity of the algorithms needed for data embedding and recovery purpose.

All these requirements are related in conflicting manner and the particular algorithmic development emphasizes to a greater extent on one or more such requirements depending on the type of application.

In digital communication spread spectrum modulation finds wide usages in hostile environment as well as in multiple access communication system due to its inherent anti-jamming

and interference rejection property [11-13]. These attributes motivate researchers to develop several SS watermarking schemes for multimedia signals. The SS watermarking that uses distinct pseudo noise (PN) spreading codes for embedding each binary digit is popular and is proven to be efficient, robust and cryptographically secure.

The motivation of the present work stems from finding out factors that have greater impact on improvement in secure data communication and its detection reliability of SS watermarking scheme.

II. SPREAD SPECTRUM WATERMARKING AND DETECTION

Spread Spectrum watermarking and detection is accomplished by embedding every watermark bit over many samples of cover image using a modulated pseudo random spreading sequence [14-16]. SS watermark embedding and detection are analyzed mathematically as follows:

A. Watermark insertion

Let B denotes the binary valued watermark bits string as a sequence of N bits.

$$B = \{b_1, b_2, b_3, \dots, b_N\}, b_i \in \{1, 0\} \quad (1)$$

If I denotes the image block of length L i.e. image transformation coefficients of length L , a binary valued code pattern of length M is used to spread each watermark bit. Therefore, a set P of N code patterns, each of length M are generated to form watermark sequence W by performing the following operation.

$$[W_M] = \sum_{i=1}^N b_i [P_M]_i \quad (2)$$

The watermarked image I_w can be obtained by embedding watermark information W into the image block I . The data embedding operation can be mathematically expressed as follows:

$$[(I_w)_M] = [I_M] + \alpha \cdot [W_M] \quad (3)$$

Where α is the modulation index and its proper choice will optimize the maximum amount of allowed distortion and minimum watermark energy needed for a reliable detection. α may or may not be a function of image coefficients. Accordingly SS watermarking schemes can be called as signal adaptive or non-adaptive SS watermarking.

B. Watermark detection

In SS watermarking, the detection reliability for binary valued watermark depends on decision variable t_i obtained by computing the zero lag spatial cross-covariance function

Manuscript received on January 2, 2006.

T. S. Das is with the Gurunanak Institute of Technology, Panihati, 700114, India (e-mail: tirthasankardas@yahoo.com).

A. K. Sau is with the Jadavpur University, Jadavpur-700032, India (e-mail: ayankumarsau@yahoo.com).

S. K. Sarkar is with the Jadavpur University, Jadavpur-700032, India (e-mail: sksarkar@etce.jdvu.ac.in).

between the watermarked image I_w and every code pattern P_i . The decision variable t_i can be mathematically expressed as follows:

$$t_i = \langle P_i - m_1(P_i), I_w - m_1(I_w) \rangle(0) \quad (4)$$

where $m_1(S)$ represents the average of the sequence S . If S_k represents the elements of S with $k=1,2,3,\dots,M$ then $m_1(S)$ can be mathematically expressed as follows:

$$m_1(S) = \frac{1}{M} \sum_{k=1}^M s_k \quad (5)$$

The symbol (0) in (4) indicates the zero lag cross-correlation and for two sequences S and R , the zero lag cross correlation is given by:

$$\langle S, R \rangle(0) = \frac{1}{M} \sum_{k=1}^M s_k r_k \quad (6)$$

Where s_k and r_k are the elements of sequence S and R respectively with $k_i=1,2,3,\dots,M$.

The bit b_i is detected as zero if $t_i > 0$ and as one otherwise. If the code pattern P_i is chosen in such a way so that $m_1(P_i) = 0 \forall i$, the computation of t_i becomes

$$t_i = \left\langle P_i, \left[I + \alpha \cdot \sum_{i=1}^N b_i P_i - m_1(I) \right] \right\rangle \quad (7)$$

$$= \langle P_i, I \rangle + \alpha \cdot \sum_{i=1}^N b_i \langle P_i, P_i \rangle - \langle P_i, m_1(I) \rangle \quad (8)$$

$$= \langle P_i, I_w \rangle \quad (9)$$

III. DESIRABLE PROPERTIES FOR IMPROVED WATERMARK DETECTION

This analysis indicates that the code patterns used for spread spectrum watermarking should possess some specific properties. Watermark detection is improved if the following conditions are satisfied:

1. $P_i, i=1, 2, 3, \dots, M$ should be distinct sequences with zero average.
2. The spatial correlations $\langle P_i, P_j \rangle, i \neq j$ should be minimized. Ideally sequences P_i and P_j should be orthogonal whenever $i \neq j$.
3. Each P_i for $i=1,2,3,\dots,M$ should be uncorrelated with the image block I when image prediction (for estimating image distortion) is not used before evaluating the cross-correlation.

A. Transform for data hiding

Over the years wavelet transform (WT) attracts attention in various image processing applications including digital image watermarking, detection, denoising and the upcoming image compression standard JPEG-2000 due to its joint representation in the form of space-frequency resolution, which provides both local and global information of image signal [17-20]. The DWT system decomposes the image signal into LL, LH, HL and HH sub bands while M band wavelet

system decomposes the same into $(M \times M)$ channels, corresponding to different direction and resolution. Such decomposition allows data embedding in different channels that offers resiliency against various image impairments. In context of SS watermarking, data embedding is recommended in wavelet coefficients of LL, LH, HL and HH sub bands (in case of DWT) and in group of channels with few highest and few lowest variance (in case of M-band WT, variance is calculated for all the $M \times M$ channels and placed in descending order; one group is formed by taking the channels of extremely high variance values and other group is formed by taking the channels of extremely low variance values) values of coefficients [21-24]. Because these above-mentioned sub bands/channels are very much dissimilar in nature compared to other combination of sub bands/channels implying that they jointly provide wide range of frequency components of cover image. To justify the selection of data embedding regions on the basis of better spectrum spreading, variance of different channels are computed. The variance for coefficients of channels $H_{12}, H_{13}, H_{14}, H_{24}$ and the channels H_{41}, H_{42}, H_{43} and H_{31} for $M (= 4)$ band system are always the few lowest and few highest values.

B. Code Properties

High detection reliability can be achieved if code pattern sequences possess very low zero lag cross correlation among each other as well as with image block when image prediction is not used to evaluate the cross correlation [25, 26]. The code patterns P_i used frequently for SS modulations are

| | | |
|-----|-----|-----|
| LL2 | LH2 | LH1 |
| LL1 | | |
| HL2 | HH2 | HH1 |
| HL1 | | |

(a)

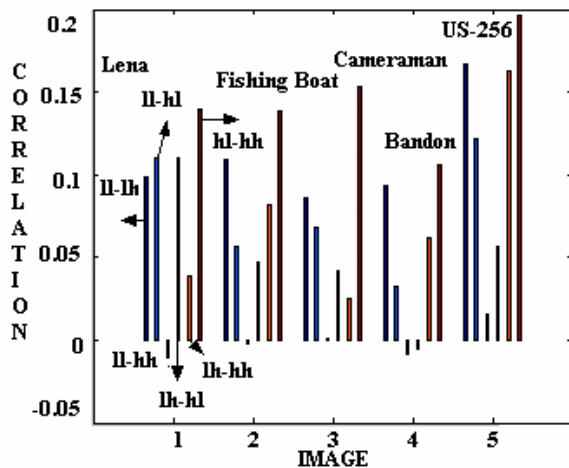

(b)

Fig. 1 (a) Sub bands corresponding to DWT decomposition (b) Cross covariance among different DWT sub bands

pseudorandom or pseudo noise (PN) sequences. The rand () and srand () functions of ANSI C library can be used to generate PN sequences by linear congruential generators. Here Matlab's PN generator can also be used. But in both

digital cellular system (IS-95) developed by Qual comm. Inc [28-30].

C. Choice of modulation functions

The main idea behind the improvement in detection reliability is to exploit the knowledge about the signal I (or more respectively, the projection of I on the watermark) and accordingly to modulate the energy of the inserted watermark in order to compensate for the signal interference. To accomplish this signal adaptive SS watermarking, we vary the amplitude of the inserted chip sequence by using linear and power-law transformation functions. We show under, a fixed attack distortion, better detection reliability in such cases is possible compared to conventional signal non-adaptive SS scheme. We now have three different forms of watermarked image as follows:

$$I = I \pm k.[P_i] \tag{10}$$

$$I = I \pm k_1.I.[P_i] \tag{11}$$

$$I = I \pm I^\mu.[P_i] \tag{12}$$

Equation (10) represents conventional signal non-adaptive SS watermarking scheme where as (11) and (12) are signal adaptive SS watermarking scheme using linear and power-law modulation functions respectively.

TABLE I
IMPROVEMENT IN ZERO AVERAGING FOR 'MATLAB' GENERATED PN SEQUENCE USING WALSH/HADAMARD BASIS

| 0Code Patterns (PN _i) size (128 x 128) | No. of 0s before modula- tion | No. of 1s before modula- tion | No. of 0s after modula- tion | No. of 1s after modula- tion |
|--|---|---|--|--|
| PN1 | 4130 | 12254 | 8170 | 8214 |
| PN2 | 4147 | 12237 | 8189 | 8195 |
| PN3 | 4167 | 12217 | 8216 | 8168 |
| PN4 | 4170 | 12214 | 8173 | 8211 |
| PN5 | 4125 | 12259 | 8190 | 8194 |

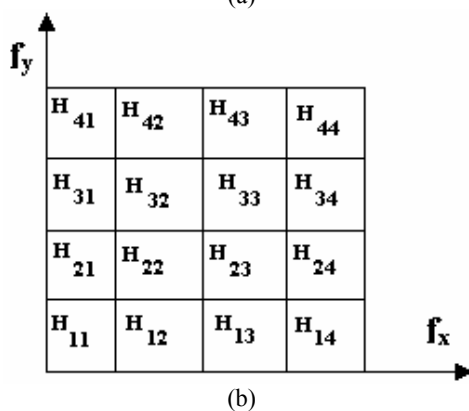
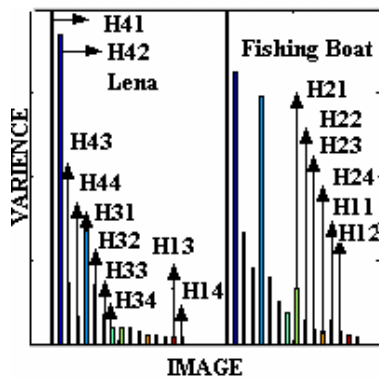

Fig. 2 (a) Variance of different channels; (b) Frequency bands corresponding to M=4 band decomposition

cases the desired properties of $m_1(P_i) = 0$ and $\langle P_i, P_j \rangle = 0$ for $j \neq i$ can be theoretically guaranteed if infinite length sequences, which of course is not feasible for practical image processing operation. The widely used PN codes in spread spectrum modulation is the maximum length sequence or m-sequences that exhibit some correlation among each other and does not provide good detection. Mayer et al proposed deterministic sequences from Walsh and Hadamard basis and generation by Gram-Schmidt orthogonalization of pseudorandom sequences, which would significantly increase the detection reliability compared to the traditional PN generation when the image block size is small [27]. On the other hand, for better spectrum spreading of the embedded data the image block with large size is desirable. Moreover if Walsh Hadamard basis is used as spreading codes the embedded data may be extracted by third party due to the deterministic nature of the basis function. To solve the problems Walsh/Hadamard basis function is used here to modulate the code patterns. Each PN code is XOR-ed with a row of Hadamard or Walsh matrix of proper dimension, which is analogous to the Walsh covering in DS-CDMA

In all the above equations I' represents watermarked image coefficients, I are image coefficients, P_i is the code pattern with length equal to the image block, k is the gain factor or modulation index, k₁ is the ratio of minimum image coefficient to maximum image coefficient, a negative quantity, μ is the modulation index in power law modulation function. The modulation index μ is negative numeric quantity with value 0 to -1.

Detection reliability in each case is determined by the stability of the decision variable t_i with respect to a given attack distortion. The expression of t_i for a particular P_i is rewritten here for convenience of our further analysis.

$$t_i = \langle I', P_i \rangle \tag{13}$$

$$= \frac{1}{M} \langle I', P_{il} \rangle$$

where l is the length of the sequence. If we substitute the value of Γ from (10), (11) and (12) into (13), the expressions of t_i becomes as follows respectively:

$$t_i = 1/M \sum_{l=1}^M (I_l \pm k.P_{il})(P_{il})$$

$$= 1/M \sum_{l=1}^M (I_l.P_{il} \pm k.P_{il}^2) \quad (14)$$

$$t_{i1} = 1/M \sum_{l=1}^M (I_l \pm k_1.I_l.P_{il})(P_{il})$$

$$= 1/M \sum_{l=1}^M (I_l.P_{il} \pm k_1.I_l.P_{il}^2) \quad (15)$$

$$t_{i2} = 1/M \sum_{l=1}^M (I_l \pm I_l^\mu.P_{il})(P_{il})$$

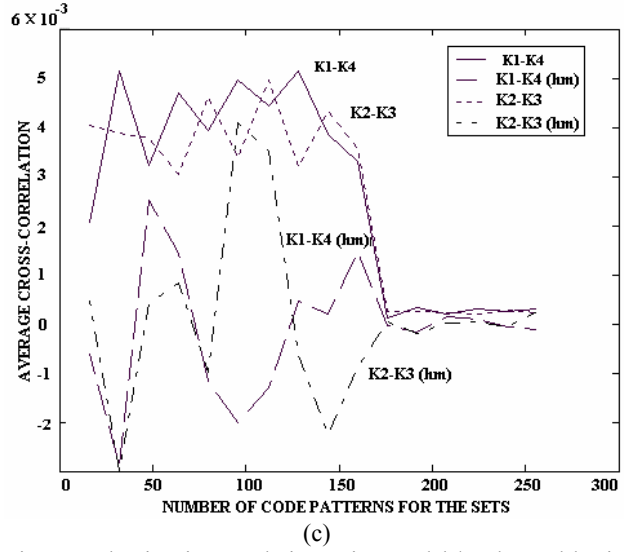
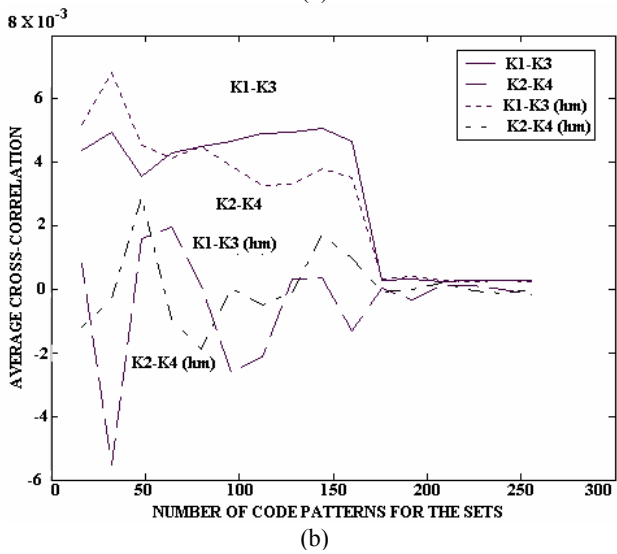
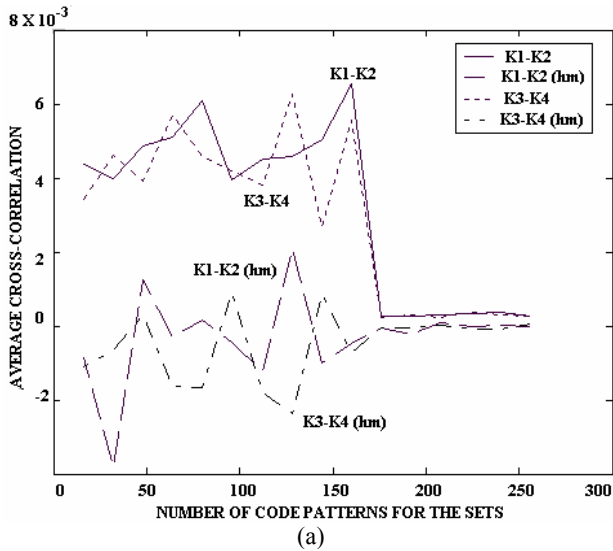

Fig. 3 Reduction in correlation using Walsh/Hadamard basis; hm indicates the correlation after modulation



$$= 1/M \sum_{l=1}^M (I_l.P_{il} \pm I_l^\mu.P_{il}^2) \quad (16)$$

It is already shown that improved detection requires zero averaging sequence i.e. in the code pattern number of zero should be equal to the number of one. Differentiating (14), (15) and (16) with respect to I_l and invoking the above property of the code pattern, we do have the expressions of dt_i / dI_l as follows:

$$dt_i / dI_l = 1/M \sum_{i=1}^M P_{il}$$

$$= 1/M (0.M/2 + 1.M/2) \quad (17)$$

$$= 1/2$$

$$dt_{i1} / dI_l = 1/M (\sum_{l=1}^M P_{il} + \sum_{l=1}^M k_1.P_{il}^2)$$

$$= 1/M (0.M/2 + 1.M/2) + k_1/2M (0.M/2 + 1.M/2) \quad (18)$$

$$= (1 + k_1)/2$$

$$dt_{i2} / dI_l = 1/M (\sum_{l=1}^M P_{il} + \mu \sum_{l=1}^M I_l^{(\mu-1)} P_{il}^2)$$

$$= 1/2 + \frac{\mu}{M} \sum_{l=1}^M I_l^{(\mu-1)} P_{il}^2 \quad (19)$$

We have defined $k_1 = I_l(\min) / I_l(\max)$ in (18), a negative quantity and let $k_1 = -k_2$, the expression of dt_i / dI_l for the equation becomes as follows:

$$dt_{i1} / dI_l = (1 - k_2) / 2 < dt_i / dI_l \quad (20)$$

In (17), (19) and (20) dt_i / dI_l denote the change of decision variable t_i with respect to the change of Γ i.e. a measure of noise immunity in the detection process. Lower value of dt_i / dI_l indicates better detection reliability.

IV. PROPOSED WATERMARKING SCHEME

A. Basic spread spectrum watermarking

Watermark information (logo/data, audio data and video data) is embedded according to (3) in channels H_{12} , H_{13} , H_{14} , H_{24} and H_{41} , H_{42} , H_{43} and H_{31} of M-band ($M = 4$) decomposition of the cover image. For each watermark bit, one PN sequence of length equal to the size of each channel is generated. If the code PN is used for data embedding in H_{41} , H_{42} , H_{43} or H_{31} channel, then the orthogonal code (PN)

different symbols and in M-ary ($M > 2$) signaling there are more than two numbers of different symbols [21, 22]. The M in M-ary refers to the number of symbols used in communication scheme. From communication theory we know that for a certain modulation scheme an increase in the number of the symbol decreases the symbol error probability. Now the use of M-ary modulation in digital watermarking is discussed in the following paragraph.

In M-ary signaling if more number of bits are used to

represent a symbol of fixed length binary message, the fewer number of symbols decrease the error probability by providing the more locations of embedding for each symbol [23, 24]. In transform domain SS watermarking scheme, the improvement in performance due to the usages of M-ary modulation can be explained as follows. When more number of bits are used to from a symbol i.e. the larger the value of M, less be the numbers of symbols need to be hidden for a given length of binary message and there is the scope of choosing of higher modulation index value. In other words for a given

embedding distortion, higher modulation index value can be chosen in M-ary signaling compared to binary signaling. The higher modulation index values improve robustness performance i.e. reliability of transmission through noisy channel.

Fig. 1 shows the block diagram of M-ary modulation based SS watermark embedding scheme. M-ary modulation scheme first maps a L bit long message (say) of two symbols signal to M different symbols message by grouping $\log_2 M$ bits of the original message to one symbol. Each symbol is represented by a bi-level spread spectrum modulation function (PN matrix) and the total number of functions in the basis set S_i (where $i = N$) should be equal to the total number of symbol message. So if $M (= 2^m)$, where each symbol is represented by m bits and N represent the number of different distinct symbols and total number of symbols in the symbol message respectively, we need M different sets of code patterns each having N number of bi-level modulation function. Fig. 7 shows the block diagram of watermark decoding in M-ary system. To decode a symbol at one particular position, correlation between the embedded image block and the modulation functions of that particular position for all the sets of keys are calculated. The index of the largest correlation coefficient i.e. the particular set of key whose modulation function of respective position yields the maximum correlation value determines the decoded symbol.

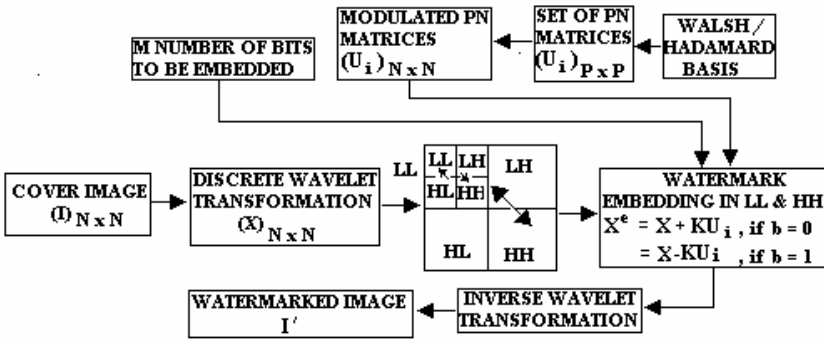

Fig. 4 Block diagram of SS watermarking scheme

obtained by complementing the bits of PN code are used for data embedding in H_{12} , H_{13} , H_{14} or H_{24} channel.

Here the data/logo is redundantly embedded in H_{41} and H_{12} channels, audio information in H_{42} and H_{13} channels and video data in H_{43} , H_{31} and H_{14} , H_{24} channels. Here our objective is to transmit multimedia data. Therefore the significant information is encoded with distinct set of keys in four channels and other two types of insignificant information is embedded using the same set of keys in only two channels

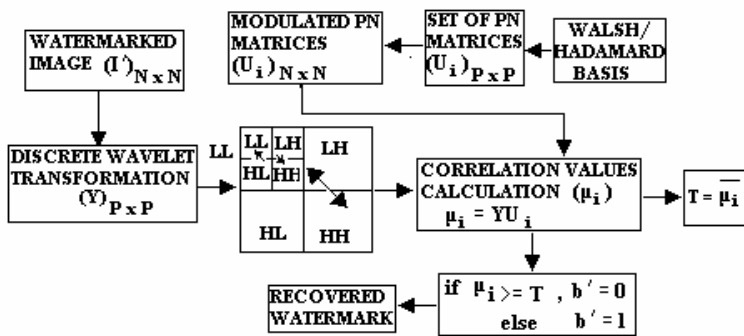

Fig. 5 Block diagram of watermark decoding

each. Since data embedding regions are different in each type of information, so there would a little interference despite the same set of keys for insignificant messages. In this way we can transmit our significant multimedia information under the camouflage of insignificant data.

B. M-ary modulation and demodulation in SS watermarking

In digital communication the smallest information entity is called as symbol where in binary signaling there are two

C. Design of experiment

We employ M-ary modulation in SS data embedding for digital images although the experiments, which can also be done for other kind of data, like audio, music, video etc. The

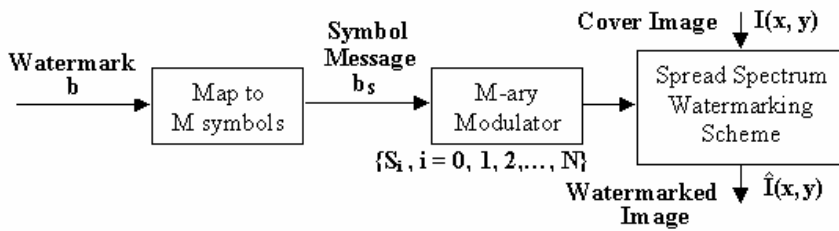

Fig. 6 Block diagram of M-ary based SS watermarking scheme

cover image I is a gray level image of size $(N \times N)$ where $N = 2^p$ and the reference watermark w is a binary image of size $(M \times M)$ where $M = 2^n$. The values of p and n , indicate the size of the cover and the watermark image where $p > n$, typically $(p/n) > 4$. The proposed work considers a binary image size (16×16) as watermark and (256) , 8 bits/pixel gray image as cover image. In order to show the better comparison of M-ary modulation scheme, data is embedded separately in spatial (directly in pixel values) domain as well as in transform domain. Although there are many transformations such as DCT, DFT, Fourier- Mellin, DHT etc. but we use here discrete wavelet transform (DWT) as it attracts attention in various image processing application including digital image watermarking, detection, de noising and the upcoming image compression standard JPEG-2000 due to its co-joint representation of the image signal [25]. The normal DWT (2

system) with low and high variance values. In the case of M-band wavelet decomposition (where $M=4$) results obtained from the large number of images show that the variance values

for the coefficients of sub bands $H_{12}, H_{13}, H_{14}, H_{24}$ are always in the lower range and for the sub bands $H_{41}, H_{42}, H_{43}, H_{31}$, are in the upper range. A set of binary valued Pseudo Number (PN) equal to the size of image block are generated and for each PN the orthogonal code PN is obtained by complementing the bits of PN code. Each PN and PN matrix are

modulated by one row of Hadamard matrix with proper dimension. Hadamard basis is used to decrease cross-correlation among PN codes. This is possible since rows and columns are orthogonal to each other. If the code PN is used for data embedding in LL sub band ($H_{12}, H_{13}, H_{14}, H_{24}$), the orthogonal code PN obtained by complementing the bits of PN are used for data embedding in HH sub band ($H_{41}, H_{42}, H_{43}, H_{31}$). The use of PN and PN indicates low corresponding image blocks i.e. sub bands or channels and property (3) of the code pattern is thus fulfilled.

V. RESULTS AND DISCUSSION

We test the effect of several above-mentioned factors in robustness improvement over large number of bench marked images like Fishing Boat, Lena, Pills, US air force etc. We use peak signal to noise ratio (PSNR) and structural similarity

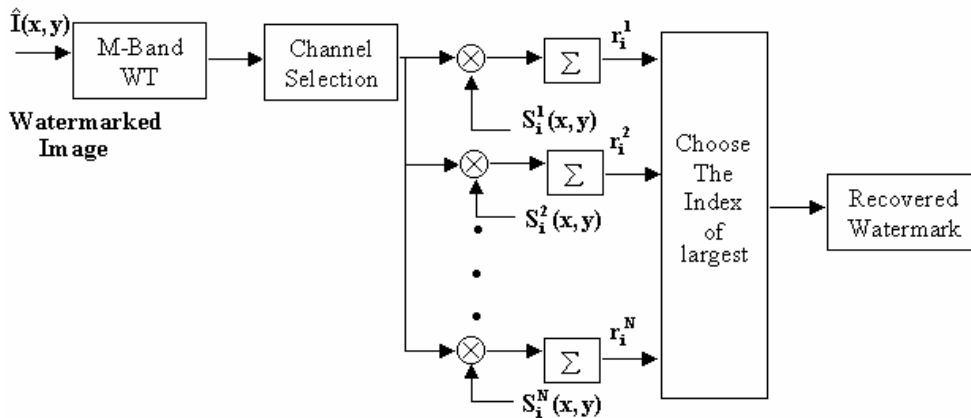

Fig. 7 Block diagram of watermark decoding in M-ary system

band system) decomposes an image signal into LL (low- low), LH (low- high), HL (high-low) and HH (high-high) sub bands while the M-band discrete wavelet transformation (MbDWT) system decomposes the same into $(M \times M)$ channels, corresponding to different direction and resolution. In case of DWT decomposition these sub bands correspond to the coarse approximation, horizontal, vertical and diagonal detail of the image signal respectively. In order to accomplish better spectrum spreading we embedded data in LL and HH sub bands (2 band system) and few selected channels (M-band

index measurement (SSIM) as representative objective measure of data imperceptibility where as relative entropy distance (Kullback Leibler distance) as measure of security (ϵ). Numerical results for these measures are shown in table II and III. Various non malicious as well as deliberate image degradation in the form of linear & nonlinear filtering, sharpening, histogram equalization, change in dynamic range, collusion, corruption by additive noise

and speckle and random noise, lossy image compression like JPEG & JPEG-2000 etc. have been simulated over the watermarked images as proof of the improvement in detection reliability. However we only show the improvement in detection against additive white gaussian noise and JPEG & JPEG-2000 compression. We treat digital watermarking as a problem of digital communication and mutual information is considered as objective measure to quantify the robustness efficiency.

Experimental results show that data embedding in M-band coefficients show better robustness compared to DWT domain

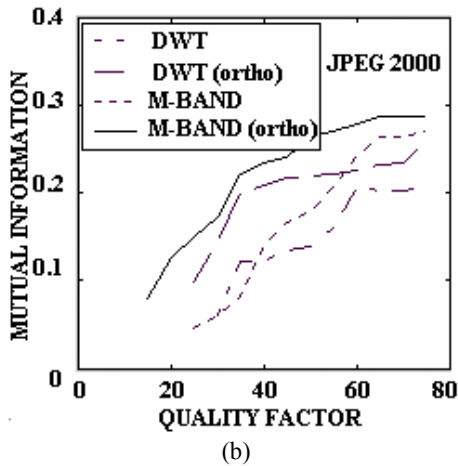
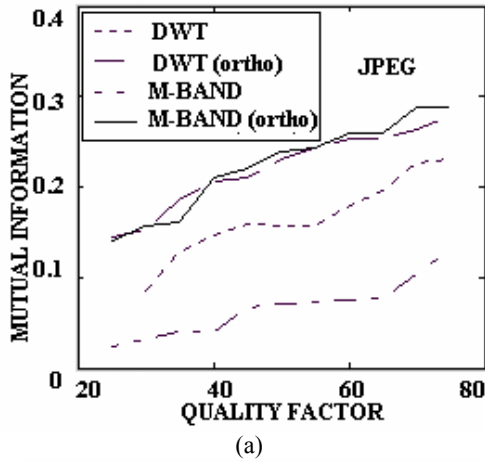

Fig. 8 Robustness results against (a) JPEG; (b) JPEG-2000 compression; 'hm' indicates modulation using Hadamard basis

embedding although the performance of the latter is much better with respect to other SS watermarking schemes implemented by using DCT, Walsh-Hadamard transformation. Fig. 8 and 9 show graphically the improvement in detection reliability against JPEG, JPEG 2000 compression for M-band over DWT decomposition. The figures also highlight the effect of Walsh-Hadamard basis in improving the robustness efficiency. The role of using different modulation functions in robustness improvement is shown in table against additive white gaussian noise. The figure shows that with the increase of depth of noise addition linear modulation function show better detection compared to traditional SS watermarking scheme. This is quite clear from (17) and (20) where for a given attack distortion change in decision variable t_i in case of linear modulation function is less compared to conventional modulation function. Under the same circumstance a better detection is achieved in power-law function is used instead of linear modulation function. This is due to the fact that with the decrease in numerical value of μ , the variance of the embedded coefficients of the sub bands is increased. The

increased variance value is the reason of low correlation between the image blocks and code patterns (19). Low correlation value reduces the value of dt_i / dl for a given attack distortion.

In case of M-ary modulation, SS watermarking scheme is

TABLE II
RESULTS OF PSNR, SSIM SECURITY VALUE FOR FISHING BOAT IMAGE USING DWT AND M-BAND DECOMPOSITION

| Decomposition Technique | PSNR value (dB) | SSIM value | Security (ϵ) value |
|-------------------------|-----------------|------------|-------------------------------|
| DWT | 38.74 | 0.9740 | 0.01786 |
| M-Band | 40.04 | 0.9789 | 0.01444 |

applied over large number of bench marked images. Data is embedded separately in spatial domain, LL and HH sub bands obtained after DWT decomposition and few selective sub channels of low and high variance blocks after M-band decomposition. The performance of M-ary modulation is shown in Fig. 10 where it is quite clear that with the increase of M value robustness efficiency is also improved but at the same time computation cost of decoding is also increased. The reason for the latter point is that for decoding a particular symbol the embedded channel is projected onto the all modulation functions of that particular position for each set of the key. It is also clear from the figures that robustness performance for any value of M in M-ary modulation is better for M-band wavelet decomposition compared to DWT decomposition while the performance of the latter is comparatively better than spatial domain SS embedding scheme. The result is reported for JPEG-2000 compression operation; however the result is also valid for other types of signal processing operation such as linear & nonlinear filtering, sharpening, histogram equalization, change in

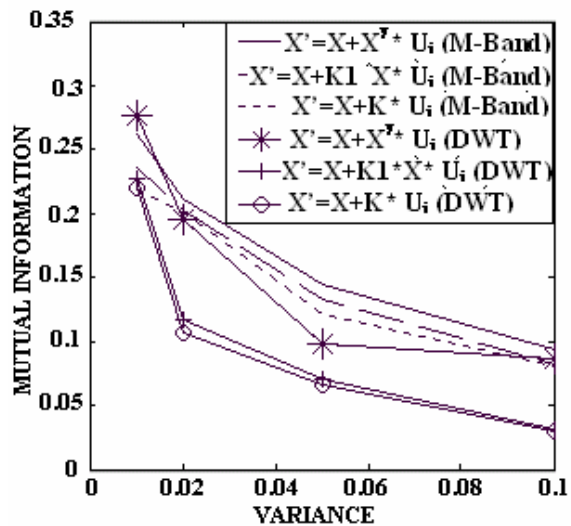
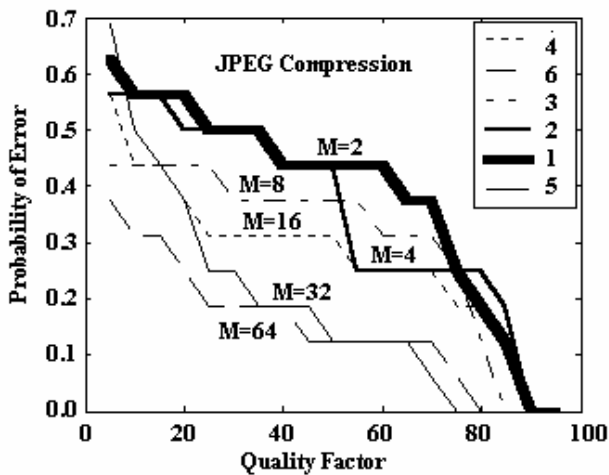
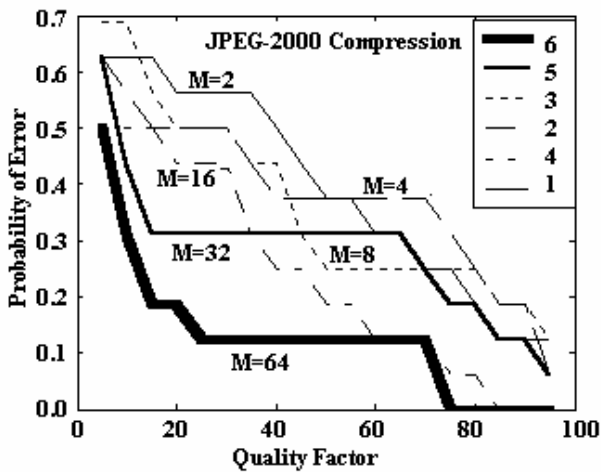

Fig. 9 Robustness result of different modulation functions for fixed gaussian noise distortion



(a)



(b)

Fig. 10 M-ary modulation for (a) JPEG compression; (b) JPEG-2000 compression

dynamic range, corruption by additive noise as well as other popular lossy image compression like JPEG.

A. Increased Capacity using multiple watermarking & bi-orthogonal wavelet.

The capacity of the watermarked image can be increased using Spread Spectrum Multiple watermarking scheme. Here, the multiple watermarks are embedded over the same cover image using the same basic watermarking technique but with distinct set of keys. Therefore more than one authenticate user can easily use the same cover image for data embedding and complete secrecy of their information (i.e. watermark) can be maintained among those users. Since Spread Spectrum technique is used for data embedding and it is popular for its anti-jamming and interference rejection property, so this scheme shows better imperceptibility as well as robustness compared to the other non Spread Spectrum techniques.

The disadvantage of this multiple watermarking is that, although Spread Spectrum is used for watermarking but

embedding distortion can't be ignored. Since all the watermarks are embedded in the same direction of the wavelet decomposition of the cover image so naturally adjacent channel interference would be the maximum. Therefore the security of the different hidden messages also would be affected. In order to increase the capacity of the watermarked image with minimum embedding distortion, the biorthogonal wavelet transform is used here. Its special feature is that it provides two scaling functions instead of one and therefore just like quadrature phase shift keying this transform gives four possible direction of decomposition. If the correlations among all these directions by taking two at a time are seem to be minimum then we can infer that all the co-channel and adjacent channel interference will be minimum. So we can expect a better imperceptibility, robustness as well as security of the hidden data. Another advantage is that since biorthogonal wavelet decomposition provides four data embedding direction, so the four different watermarks can be embedded using the same set of key instead of different sets of key. Therefore, the time complexity of the key rather code generation would be much simplified.

B. Successive bit/watermark cancellation method

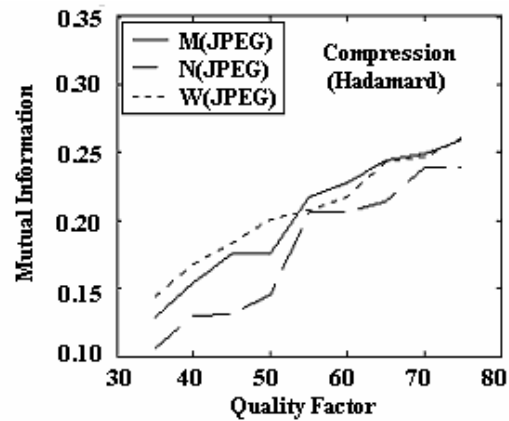

(a)

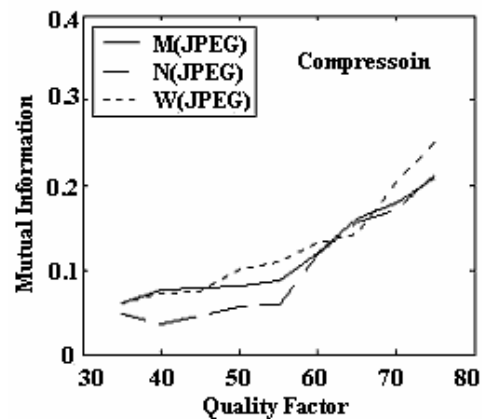

(b)

Fig. 11 (a) JPEG compression (with orthogonality); (b) JPEG compression (without orthogonality)

Each bit of the watermark is retrieved on the basis of cross-correlation threshold value. Since multiple watermarks (text, audio and video i.e. multimedia data) are simultaneously embedded on the same cover image, therefore the interference among them would greatly impact on the decoding process i.e.

Detection reliability is also improved by employing the successive watermark/bit cancellation method resulting in reduced interference among the embedded watermarks. The data embedding capacity is greatly increased by using biorthogonal wavelets. Proposed SS watermarking scheme also offers visual and statistical invisibility of the hidden data. Here, the embedded watermarks are not only image but also audio or video clips etc. So, the reported results are based on multimedia data as watermarks, which are simultaneously embedded over the same image.

ACKNOWLEDGEMENTS

Dr. Subir Kumar Sarkar acknowledges the final assistance obtained from the Center for Mobile Computing and Communication, Jadavpur University.

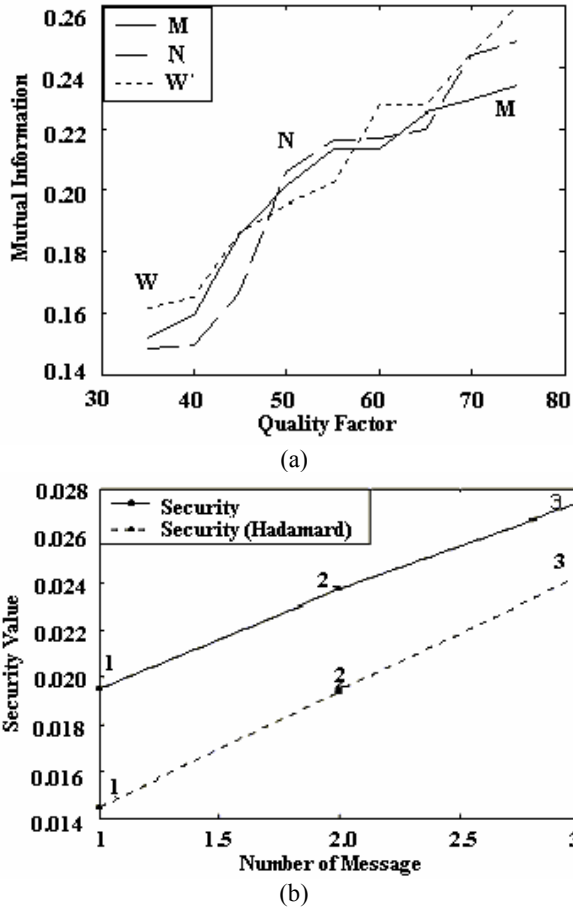

Fig. 12 (a) JPEG-2000 compression (with orthogonality); (b) Security (with & without orthogonality) for multiple messages

on the stability of the threshold values. In order to dehide each type of watermark properly, this interference has to be minimized. Therefore, here successive watermark cancellation as well as successive bit cancellation methods are employed during the watermark recovers process for this purpose. The results show that successive bit cancellation method is far better than successive watermark cancellation and normal decoding process as it greatly decreases this interference.

VI. CONCLUSION

In this paper, we have critically analyzed few issues that have significant impact on the detection reliability in SS watermarking for the purpose of secure data communication. It is found that data embedding in the channels ($H_{12}, H_{13}, H_{14}, H_{24}$ or $H_{41}, H_{42}, H_{43}, H_{31}$) of M-band decomposition offers higher resiliency against various types of image distortion. Detection reliability is improved by increasing orthogonality among code patterns using Walsh-Hadamard basis functions.

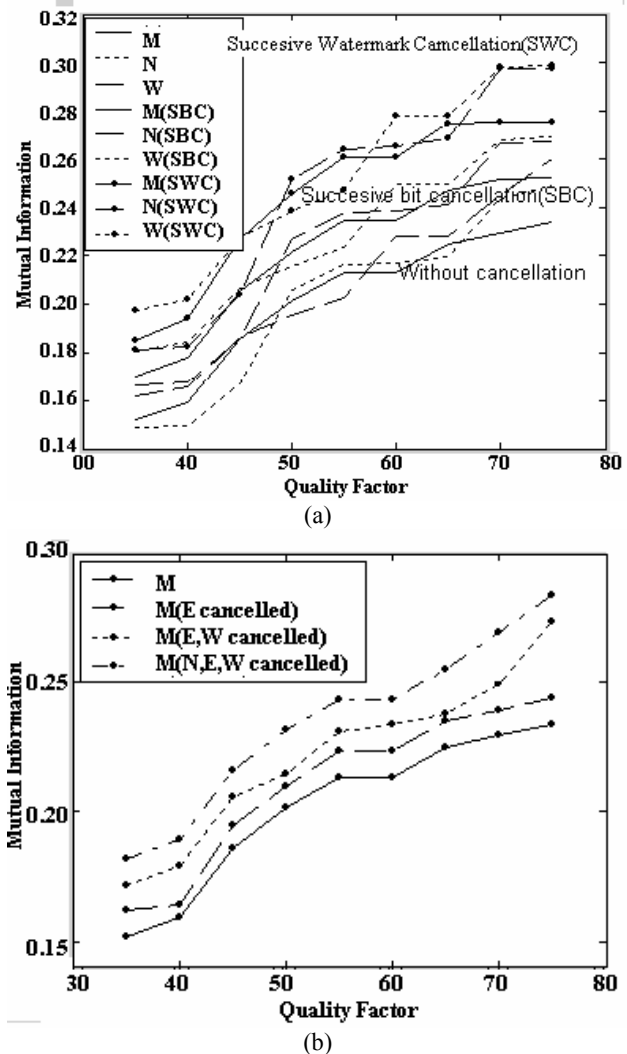

Fig. 13 (a) Successive bit and watermark cancellation on JPEG 2000 compressed image; (b) Successive watermark cancellation (Four different watermarks M, N, W & E are embedded using bior 6.8 filter and) form a JPEG2000 compressed image

TABLE III
RESULTS OF PSNR, SSIM AND SECURITY VALUE USING BI-ORTHOGONAL WAVELET DECOMPOSITION AFTER EMBEDDING FOUR WATERMARKS

| Name of the Image | Name of the biorthogonal Filter | PSNR (dB) | SSIM | Security Value |
|-------------------|---------------------------------|-----------|--------|----------------|
| Fishing Boat | bior 4.4 | 35.318327 | 0.9307 | 0.021536 |
| | bior 5.5 | 35.407409 | 0.9329 | 0.021243 |
| | bior 6.8 | 35.494210 | 0.9452 | 0.020452 |

REFERENCES

- [1] I. J. Cox and M. L. Miller, "A Review of Watermarking and the Importance of perceptual Modeling", *Proc of Electronic Images*, Feb. 1997.
- [2] N. Nikolaidis, I. Pitas, "Robust Image Watermarking in the Spatial Domain", *Elsevier Signal Processing*, Sept. 1997, pp. 385-403.
- [3] G.W. Braudaway, "Protecting publicly available images with an invisible image Watermark", *Int. Conf. On Image Processing*, vol. 1 Oct. 1997.
- [4] C.T. Hsu, J. L. Wu, "Hidden signatures in images", *Int. Conf. On Image Process*, vol. 3, Lausanne, Switzerland, Sept. 1996.
- [5] P. Maulin and A. Ivanovic, *IEEE Trans on signal processing*, Apr. 2003, vol. 51, pp 1098 -1117.
- [6] X. Niu, S. Sun, W. Xiang, "Multi-resolution Watermarking for Video Based on Gray-level Digital Watermark", *IEEE Trans. Consumer Electronics* vol. 46, May 2000.
- [7] W. Bender, D. Gruhl, N. Morimoto and A. Lu, "Techniques for Data Hiding", *IBM systems journal*, vol. 35, pp 3-4, 1996.
- [8] G. Mazzini, G. Setti and R. Rovatti, "Chaotic complex spreading sequences for asynchronous DS-CDMA", *IEEE Trans on Circuits & Systems' 97*.
- [9] A. B. Watson, G. Y. Yang, J. A. Solomon, J. Villasenor, "Visibility of Wavelet Quantization Noise", *IEEE Trans on Image Processing* vol. 6, August 1997.
- [10] B. L. W. Zeng, S. Lei, "Extraction of multiresolution watermark images for resolving rightful ownership", *Proc. of SPIE, Security and Watermarking of Multimedia Contents*, January 1999.
- [11] I. J. Cox, J. Killian, F. T. Leighton, T. Shamoan, "Secured Spread Spectrum Watermarking for Multimedia", *IEEE Trans on Image Processing*, vol. 6, pp 601-610, June 2000.
- [12] M. Bani, F. Bartolini and A. De, "Rosa, on the performance of multiplicative spread spectrum watermarking", *proc. on IEEE work on MMSP'02*
- [13] I. J. Cox and M. L. Miller, and A. L. McKellips, "Watermarking as communications with side information", *Proc. of IEEE'99*.
- [14] S. Craver, N. Memon, B. L. Yeo and M. M. Yeung, "Resolving Rightful Ownership with Invisible Watermarking Techniques: Limitations, Attacks and Implications", *IEEE Journal of Selected Areas in Communications'98*.
- [15] J.R.Hernandez and F.Perez- Gonzales, "Statistical analysis of watermarking schemes for copyright protection of images", *Proc. of IEEE, 99*.
- [16] N. Merhav, "Random coding error exponents of watermarking systems", *IEEE Trans on Information Theory'2000*.
- [17] M. Barni, F. Bartolini, A. Piva, "Improved wavelet-based watermarking through pixel-wise masking", *IEEE Trans. on Image Processing*, pp. 783-791, 2001.
- [18] W. Dietl, P. Meerwald, A. Uhl, "Protection of wavelet based watermarking systems using filter parameterizations", *Signal Processing*, October 2003.
- [19] D. Kundur, D. Hatzinakos, "Towards Robust logo watermarking using multiresolution image fusion", *IEEE Trans. Multimedia* 6, Feb. 2004.
- [20] P. Meerwald, A. Uhl, "A survey of wavelet-domain watermarking algorithms", In *Proc. of SPIE, Electronic Imaging, Security And Watermarking of Multimedia ContentsIII*, CA, USA4314, Jan. 2001.
- [21] Wang, Y., Doherty, J. F., VanDyck, R.E., "A wavelet based watermarking algorithm for ownership verification of digital images", *IEEE Trans. Image Process* 11, February 2002.
- [22] M. K. Kundu and M. Acharya, "M-Band Wavelets: Application to Texture Segmentation for Real Life Image Analysis", *Proc. International journal of wavelets, Multiresolution and Information proceeding*, vol. 1, pp115-149, 2003.
- [23] Philippe D., Benoit M., and Dirk T. M. S., "Signal adapted multiresolution transform for image coding", *IEEE Trans on Information Theory*, 38(2), March 1992.
- [24] H. S. Malvar and D. A. F Florencio, "Improved Spread Spectrum: A new Modulation Technique for Robust Watermarking", *IEEE Trans on signal processing*, April 2003, pp 898-905.
- [25] A. Chouly, A. Brajal and S. Jourdan, "Orthogonal multicarrier techniques applied to direct sequence spread spectrum CDMA systems", *Proc of IEEE GLOBECOM'93*.
- [26] S. Hara and R. Prasad, "Overview of multicarrier CDMA", *IEEE communication Mag'97*.
- [27] V. M. Dasilva and E. S. Sousa, "Performance of orthogonal CDMA codes for quasi-synchronous communication systems", *Proc. of IEEE ICUPC'93*.
- [28] S. Kaiser, "OFDM-CDMA vs. DS-CDMA: Performance evaluation for fading channels", *Proc. of IEEE ICC'95*.
- [29] L. Vandendorpe, "Multitone Spread Spectrum Multiple Access Communications System in a Multipath Rician Fading Channel", *IEEE Trans Vehic'95*.
- [30] N. Yee, L. Linnartz and G. Fettweis, "Multicarrier CDMA in Indoor Wireless Radio Networks", *Proc of IEEE PIMRC'93*.



Tirtha Sankar Das became member of IEEE in 2005. He received his B. Tech degree in Electronics and Telecommunication Engineering from Vidyasagar University, WB, India in 2002 and M.E. degree from Bengal Engineering & Science University, Shibpore in 2004.

At present he is a Lecturer in Electronics and Communication at Gurunanak Institute of Technology, Panihati, Kolkata, India. He is currently doing his Ph.D under Prof. S.K.Sarkar in Jadavpur University. His field of interest spans digital image processing, signal processing, communication and VLSI.

Ayan Kumar Sau received his B. Tech degree in Electronics and Telecommunication from Kalyani University, WB, India in 2002.



encryption.



Dr. Subir Kumar Sarkar received his B. Tech. from University of Calcutta, India in 1981, M. Tech. from University of Calcutta, India in 1983 and Ph. D (Tech) from Institute of Radio Physics and Electronics, University of Calcutta in 1999.

From 1992 to 1999 he was lecturer in Bengal Engineering and Science University, Shibpore, Howrah. Currently he is Reader in Jadavpur University, Kolkata, India, since 1999. His present field of interest is application of soft computing tools in simulations of device models and also in the field of High Frequency and Low Power Consuming Devices and their parameter optimization and wireless mobile communication. His research interests also include single electron devices and next generation digital electronics and image processing.