

# Chattering phenomenon suppression of buck boost DC-DC converter with Fuzzy Sliding Modes Control

Abdelaziz Sahbani, Kamel Ben Saad, and Mohamed Benrejeb

**Abstract**—This paper proposes a Fuzzy Sliding Mode Control (FSMC) as a control strategy for Buck-Boost DC-DC converter. The proposed fuzzy controller specifies changes in the control signal based on the knowledge of the surface and the surface change to satisfy the sliding mode stability and attraction conditions. The performances of the proposed fuzzy sliding controller are compared to those obtained by a classical sliding mode controller. The satisfactory simulation results show the efficiency of the proposed control law which reduces the chattering phenomenon. Moreover, the obtained results prove the robustness of the proposed control law against variation of the load resistance and the input voltage of the studied converter.

**Keywords**—Buck Boost converter, Sliding Mode Control, Fuzzy Sliding Mode Control, robustness, chattering.

## I. INTRODUCTION

A DC-DC converter must provide a regulated DC output voltage even when varying load or the input voltage varies. The two most common closed-loop control methods for PWM DC-DC converters are the voltage-mode control and the current-mode control. An important advantage of the voltage-mode control is its simple hardware implementation and flexibility [1]-[3].

Among the control methods of DC-DC converters, the hysteretic control is very simple for hardware implementation. However, the hysteretic control induces a variable frequency operation of the power switches.

Generally, the linear conventional control solutions applied to power electronic system, especially for buck boost converters, failed to accomplish robustness under nonlinearity, parameter variation, load disturbance and input voltage variation. As an example, the design of a PID controller is based on the Bode plots or tuned with Ziegler-Nichols techniques. Due to the highly nonlinear characteristics of the DC-DC converters, the PID control does not allow disturbances rejection and fast transient response time.

As a result, there is more interest in developing more nonlinear and advanced non-conventional robust control structures to improve the performance of the DC-DC converters.

Sliding mode controllers are well known for their robustness and stability but this kind of controller operate at infinite

A. Sahbani, K. Ben Saad and M. Benrejeb are with the research unit LARA of the école nationale d'ingnieurs de tunis, BO 37, le belvedere 1002, Tunis, Tunisia, phone 0021671874700, fax 0021671872729 e-mail bensaad.kamel@gnet.tn

switching frequency so-called chattering phenomenon [4]. But the high speed switching in power converter introduces an excessive switching losses and electromagnetic interference noise issues [5].

Generally, a constant switching frequency is preferred in power electronic circuits for easier elimination of this electromagnetic interference and better use of the magnetic components [1], [5] and [6].

This paper proposes a control strategy for Buck-Boost DC-DC converter considering all the details of a real power circuit and working in fixed frequency PWM based Fuzzy Sliding Mode Control (FSMC). The results obtained are compared with the ones achieved with a classical Sliding Mode Control (SMC) in terms of start-up behaviour and robustness to disturbances.

## II. BASIC PRINCIPLE OF BUCK BOOST CONVERTER

A buck-boost converter provides an output voltage which can be higher or lower than the input voltage. The output voltage polarity is opposite to that of the input voltage. Fig.1 shows a simplified structure of the buck-boost converter. It consists of a DC input voltage source ( $V_{in}$ ), a controlled switch ( $S_w$ ), a diode ( $D$ ), a filter inductor ( $L$ ), a filter capacitor ( $C$ ) and a load resistance ( $R$ ).

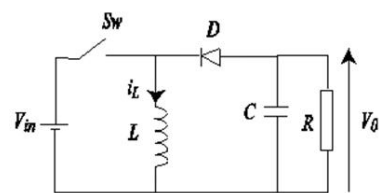

Fig. 1. Structure of the studied Buck-Boost converter

During the normal operation of the buck-boost power stage, ( $S_w$ ) is repeatedly switched *ON* and *OFF* with the on- and off-times under the control of the duty ratio. Depending on the whether the switch ( $S_w$ ) is *ON* or *OFF*, the converter operation can be divided into two modes of operation. During mode 1 the switch ( $S_w$ ) is conducting and during second mode the switch ( $S_w$ ) is open.

When the switch is *ON* the system is linear and the state-

space equations can be written as follows:

$$\begin{cases} \frac{di_L}{dt} = \frac{v_{in}}{L} \\ \frac{dv_0}{dt} = -\frac{1}{RC}v_0 \end{cases} \quad (1)$$

where the state variables are the inductance currents ( $i_L$ ) and capacitance voltages ( $v_0$ ).

When the switch is *OFF* the system is also linear and the state-space equations are given by:

$$\begin{cases} \frac{di_L}{dt} = \frac{v_0}{L} \\ \frac{dv_0}{dt} = -\frac{i_L}{C} - \frac{v_0}{RC} \end{cases} \quad (2)$$

The choice of the state vector  $x = \begin{bmatrix} x_1 \\ x_2 \end{bmatrix} = \begin{bmatrix} i_L \\ v_0 \end{bmatrix}$  allows the state-space representation for mode 1 by:

$$\begin{cases} \dot{x}_1 = A_1x + B_1u \\ v_0 = C_1x \end{cases} \quad (3)$$

Where:

$$A_1 = \begin{bmatrix} 0 & 0 \\ -\frac{1}{RC} & 0 \end{bmatrix}, B_1 = \begin{bmatrix} \frac{1}{L} \\ 0 \end{bmatrix}, C_1 = \begin{bmatrix} 0 & 1 \end{bmatrix} \text{ and } u = v_{in}$$

and the state-space representation for mode 2 by,

$$\begin{cases} \dot{x}_2 = A_2x + B_2u \\ v_0 = C_2x \end{cases} \quad (4)$$

Where:

$$A_2 = \begin{bmatrix} 0 & \frac{1}{L} \\ -\frac{1}{C} & -\frac{1}{RC} \end{bmatrix}, B_2 = \begin{bmatrix} 0 \\ 0 \end{bmatrix}, C_2 = \begin{bmatrix} 0 & 1 \end{bmatrix} \text{ and } u = v_{in}$$

The state-space averaging method replaces the state-equations by a single state-space description which represents approximately the behaviour of the circuit across the whole period. From the state-space representation of mode 1 (*ON* mode) and mode 2 (*OFF* mode) described by (3) and (4) the averaged state-space representation of buck-boost converter system is obtained and represented by the following equations:

$$\begin{cases} \dot{x} = [dA_1 + (1-d)A_2]x + [dB_1 + (1-d)B_2]v_{in} \\ v_0 = [dC_1 + (1-d)C_2]x \end{cases} \quad (5)$$

$d$  takes 1 for the on state of the switcher and 0 for the off state.

$$\begin{cases} \dot{x} = \begin{bmatrix} 0 & \frac{1-d}{L} \\ -\frac{1-d}{C} & -\frac{1}{RC} \end{bmatrix} x + \begin{bmatrix} \frac{d}{L} \\ 0 \end{bmatrix} v_{in} \\ v_0 = \begin{bmatrix} 0 & 1 \end{bmatrix} x \end{cases} \quad (6)$$

### III. SLIDING MODE CONTROL DESIGN

The SMC is a nonlinear control approach which complies with the nonlinear characteristic of a Buck-boost converter. Such control technique is robust even against the plant parametric variation and can compensate the modelling approximations. Also, it is characterized by a good dynamic response. In addition, the SMC is simple to implement [7]-[9].

The first step to design a sliding mode control is to determine the sliding surface with the desired dynamics of the corresponding sliding motion.

As an example, let us consider the following sliding surface  $S$ :

$$S = K_1(i_L - i_L^*) + K_2(v_0 - v_0^*) \quad (7)$$

Where  $K_1$  and  $K_2$  is the sliding coefficient and  $v_0^*$  is the desired output voltage and  $i_L^*$  is the desired output current.

From equation (6) we can deduce that at the stability point the reference inductor current  $i_L^*$  can be written as follow :

$$i_L^* = -\frac{v_0^*(v_0^* - v_{in})}{R v_{in}} \quad (8)$$

The sliding mode control signal  $d$  consists of two components a nonlinear component  $d_n$  and an equivalent component  $d_{eq}$ :

$$d = d_{eq} + d_n \quad (9)$$

The equivalent control can be obtained when  $S = \dot{S} = 0$ . It is expressed as follows:

$$d_{eq} = \frac{K_1RCv_0 + K_2LRi_L + K_2Lv_0}{K_2LRi_L + K_1RC(v_{in} - v_0)} \quad (10)$$

The next step is to design the control input so that the state trajectories are driven and attracted toward the sliding surface and then remain sliding on it for all subsequent time. Let us consider the positive definite Lyapunov function  $V$  defined as follows:

$$V = \frac{1}{2}S^2 \quad (11)$$

The time derivative  $\dot{V}$  of  $V$  must be negative definite  $\dot{V} < 0$  to insure the stability of the system and to make the surface  $S$  attractive. Such condition leads to the following inequality:

$$\dot{V}_1 = S\dot{S} < 0 \quad (12)$$

To satisfy the condition given by the inequality (12) the nonlinear control component can be defined as follows:

$$d_n = K_3 \cdot \text{sign}(S) \quad (13)$$

Where  $K_3$  is negative,  $K_1$  and  $K_2$  are chosen to be positive, the determination of these parameter were detailed in [4]. However, the major drawback of the SMC is the chattering phenomenon which is a consequence of the discontinuity of the nonlinear component. To overcome the disadvantage of the sliding-mode control a FSMC is proposed in the next section.

IV. FUZZY SLIDING MODE CONTROL DESIGN

The combination of the sliding mode control with the fuzzy logic control aims to improve the robustness and the performances of the controlled nonlinear systems.

Let us consider the sliding surface defined by the equation (7). The proposed fuzzy sliding mode controller forces the derivative of the Lyapunov function to be negative definite. So, the rule base table is established to satisfy the inequality (12).

Intuitively, suppose that  $S > 0$  and  $\dot{S} > 0$ , the duty cycle must increase. Also, if  $S < 0$  and  $\dot{S} < 0$  the duty cycle must decrease. Thus, the surface  $S$  and its variation  $\dot{S}$  are the inputs of the proposed controller. The output signal is the control increment  $\Delta U(k)$  which is used to update the control law. The control signal is defined as follows:

$$U(k) = \Delta U(k) + \Delta U(k - 1) \quad (14)$$

The proposed Fuzzy sliding mode controller is a zero order Sugeno fuzzy controller which is a special case of Mamdani fuzzy inference system. Only the antecedent part of the Sugeno controller has the "fuzzyness", the consequent part is a crisp function. In the Sugeno fuzzy controller, the output is obtained through weighted average of consequents [11]. Trapezoidal and triangular membership functions, denoted by N (Negative), Z (Zero) and P (Positive), were used for both the surface and the surface change. They are presented in Fig.2 and Fig.3 in the normalized domain.

For the output signals, five normalized singletons denoted by NB (Negative Big), NM (Negative Middle), Z (Zero), PM (Positive Middle), PB (Positive Big) are used for the output signal (Fig.4). The Structure of the controller is given in Fig.5.

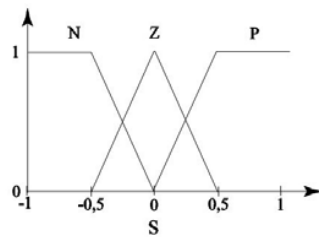

Fig. 2. Surface S membership functions

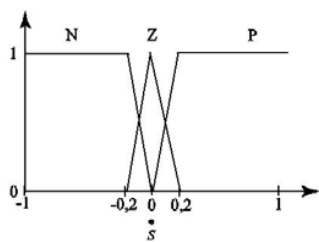

Fig. 3. Surface change membership functions

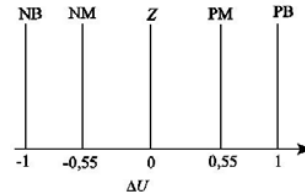

Fig. 4. Output singletons

TABLE I  
RULE BASE OF THE PROPOSED FSMC

		S		
		N	Z	P
S-dot	P	Z	PM	PB
	Z	NM	Z	PM
	N	NB	NM	Z

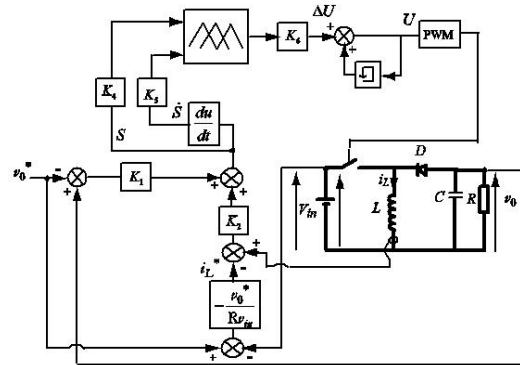

Fig. 5. Block diagram of the proposed fuzzy sliding mode control Buck converter

V. SIMULATION RESULTS

The proposed fuzzy sliding mode controller is tested by simulation. The electrical parameters of the simulated Buck Boost converter are given in table II. These parameters allow a continuous conduction mode.

The classical sliding mode control solution, described above, was compared to the proposed fuzzy sliding mode control law. Fig.6 gives the simulated step responses of the studied Buck boost converter for settling voltages  $-20V$  when the input voltage is  $15V$ . Fig.7 shows that the two controllers can regulate also the load current at any desired value. From the two figures we can conclude that the dynamical behaviour of the transient state of the responses for the voltage and the current obtained by the FSMC are a little bit different.

TABLE II  
STUDIED BUCK BOOST CONVERTER PARAMETERS

Parameters	Values
C	$100.10^{-6} F$
L	$20.10^{-3} H$
R	$20 \Omega$
Switching Frequency	$30.10^3 Hz$

The simulated results, given by Fig.8 and Fig.9, prove that the chattering phenomenon was eliminated from the signal command of the buck boost converter by application of the FSMC. Additionally, the next simulations test the robustness of the FSMC for the case of the load current variation and the input voltage variation. The Fig.10 presents the variation of the current from 1.6A to 2.45A at 0.06s. We can notice in Fig.11 that FSMC rejects such perturbation.

From Fig.12 to Fig.20 we test the buck boost DC-DC converter when the input varies. Fig.12 illustrates the variation of the input voltage from 15V to 10V. For such case we notice that the output voltage is always at the desired value -20V and the converter work as boost one. In Fig.15 the input voltage varies from 30V to 15V. Fig.16 proves that the output voltage still at the same desired value. For this simulation, the converter working mode changes from buck to boost. Fig.19 presents the robustness test results by application of the FSMC for the variation of the input voltage from 15V to 25V in which the converter working mode changes from boost to buck.

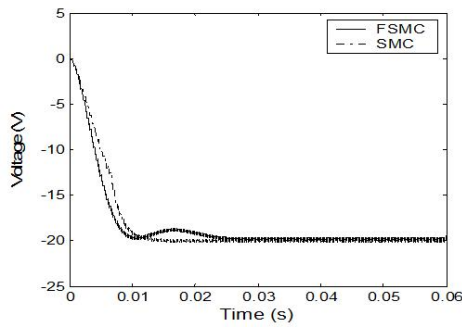

Fig. 6. Step voltage responses of the buck boost converter by application of the SMC and the FSMC

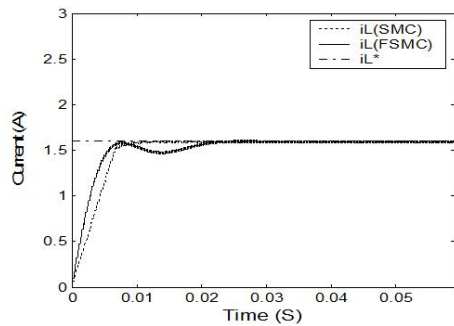

Fig. 7. Step current responses of the buck boost converter by application of the SMC and the FSMC

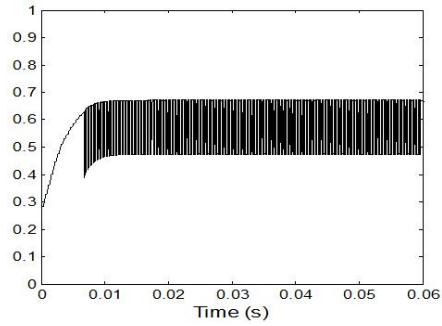

Fig. 8. Control signal of the buck boost converter by application of the SMC

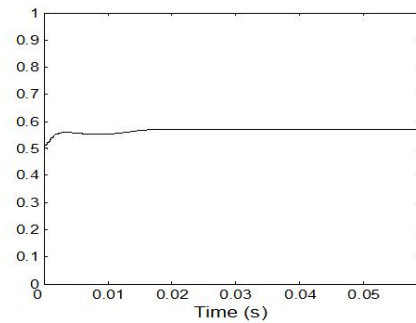

Fig. 9. Control signal of the buck boost converter by application of the FSMC

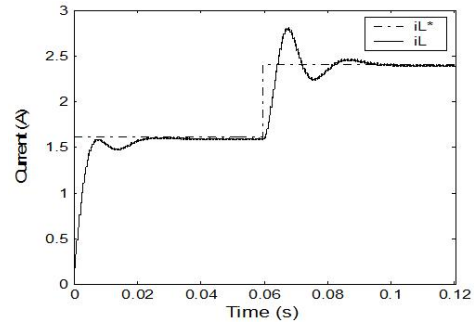

Fig. 10. Variation of the load current from 1.6A to 2.45A

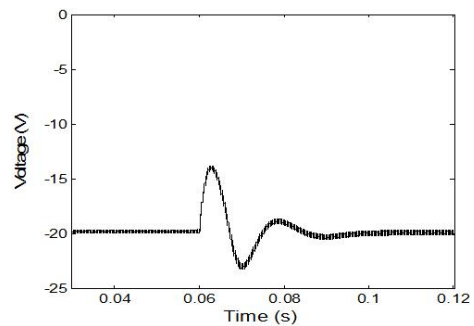

Fig. 11. Robustness test of the FSMC for the variation of the load current from 1.6A to 2.45A

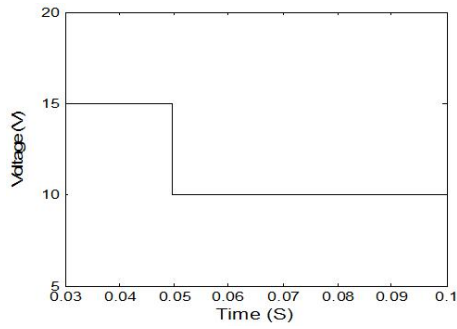

Fig. 12. Evolution of the input voltage from 15V to 10V

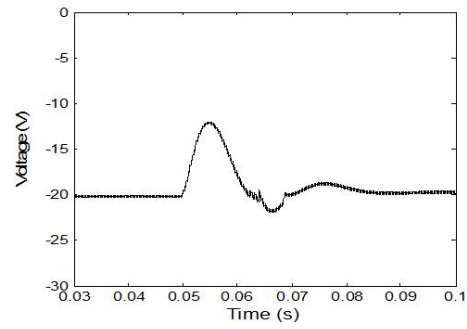

Fig. 16. Robustness test of the FSMC for the variation of the input voltage from 30V to 15V

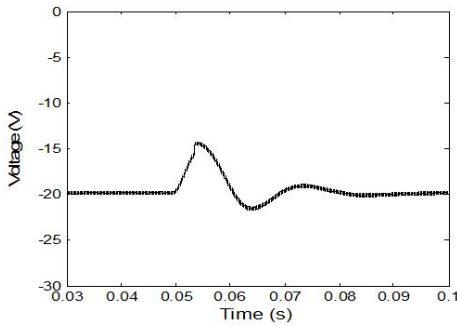

Fig. 13. Robustness test of the FSMC for the variation of the input voltage from 15V to 10V

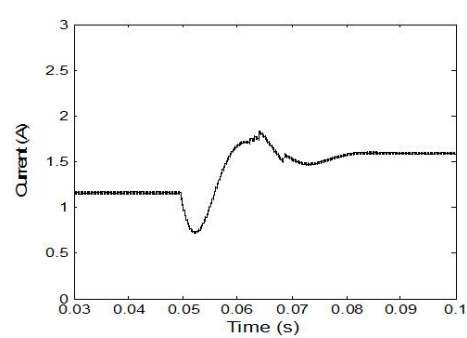

Fig. 17. Evolution of the load current when the input voltage changes from 30V to 15V

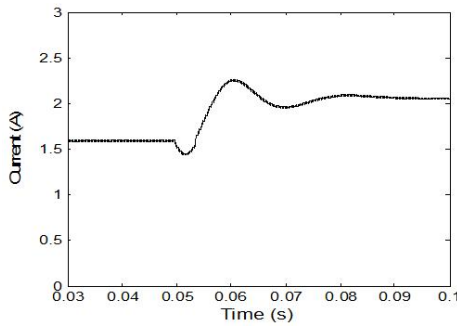

Fig. 14. Evolution of the load current when the input voltage changes from 15V to 10V

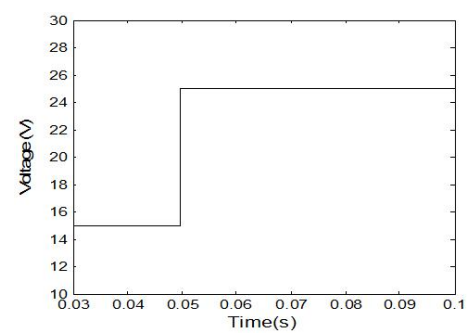

Fig. 18. Evolution of the input voltage from 15V to 25V

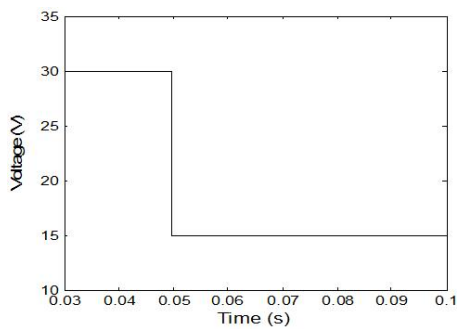

Fig. 15. Evolution of the input voltage from 30V to 15V

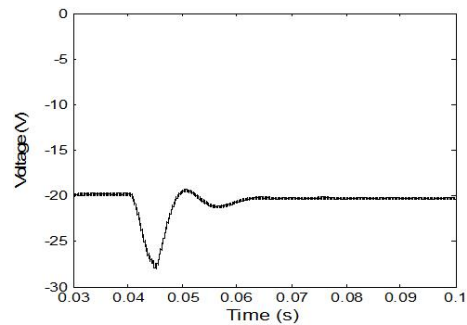

Fig. 19. Robustness test of the FSMC for the variation of the input voltage from 15V to 25V

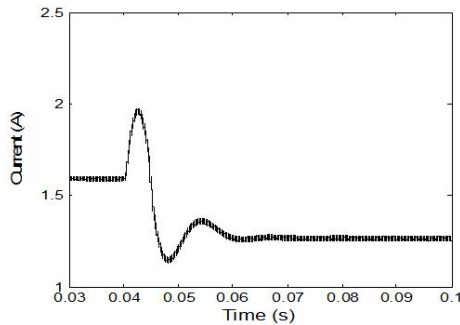

Fig. 20. Evolution of the load current when the input voltage changes from 15V to 25V

## VI. CONCLUSION

In this paper, we propose a fuzzy sliding mode control for improving the robustness and the dynamical performances of a buck boost DC-DC. The proposed fuzzy controller design has as inputs the sliding surface and its variation. It defines the control signal to satisfy the stability and the attraction condition of the sliding surface. The simulation results show that the proposed controller overcomes the chattering problem. Moreover, it is proven that the proposed controller is robust for the case of the desired output currents variation and input voltage variations.

## REFERENCES

- [1] M. H. Rashid, *Power electronics handbook*, 2nd ed. Academic Press, 1998.
- [2] R.D. Middlebrook and S. Cuk, *A General Unified Approach to Modelling Switching Power Stages*, IEEE Power Electronics Specialists Conference Rec., pp. 18-34, 1976.
- [3] M. Ahmed, M. Kuisma, K. Tolsa and P. Silventoinen, *Standard procedure for modelling the basic three converters (Buck, Boost, and Buck-boost) with PID algorithm applied*, Proceedings of the 13th International Symposium on Electrical Apparatus and Technologies (SIELA), Plovdiv, May 2003.
- [4] H. ElFadil, F. Giri and H. Ouadi, *Reducing Chattering Phenomenon in Sliding Mode Control of Buck-Boost Power Converters*, IEEE International Symposium on Industrial Electronics, 2008.
- [5] S.C. Tan, Y.M. Lai and C.K. Tse, *A fixed frequency pulse width modulation based quasi sliding mode controller for buck converter*, IEEE Transactions on Power Electronics, Vol. 20, No. 6, pp. 1379-1392, November 2005.
- [6] S.C. Tan, Y.M. Lai and C.K. Tse, *A unified approach to the design of PWM based sliding mode voltage controllers for basic DC-DC converters in continuous conduction mode*, IEEE Transactions on Circuits and Systems I, Vol. 53, No. 8, pp.1816-1827, August 2006.
- [7] C.K. Tse and K.M. Adams, *Quasi-linear analysis and control of DC-DC converters*, IEEE Transactions on Power Electronics, Vol. 7 No. 2, pp. 315-323, April 1992.
- [8] X.F. Zhong, G.J. Ye, N.H. Chen and J.L. Jiang, *Study on sliding-mode control in three-level converters*, The 4th International Power Electronics and Motion Control Conference, 2004. IPEMC 2004, Vol 3, Issue 2, pp. 1105 - 1110, August 2004.
- [9] V.M. Nguyen and C.Q. Lee, *Indirect implementations of sliding-mode control law in buck-type converters*, Proceedings of the IEEE Applied Power Electronics Conference and Exposition (APEC), Vol.1, pp.111-115, March 1996.
- [10] A. Kandel and L. Gideon, *Fuzzy control systems*, CRC Press. New York, 2000.
- [11] M.K. Passino, *Fuzzy control*, Addison-Wesley. London, 2000.

**Abdelaziz Sahbani** Was born in 1977 in Bizerte, Tunisia. He graduated in 2000 from "Ecole Supérieure de science et Technique de Tunis". He received the master's degree in Electrical Engineering in 2004 from "Ecole Supérieure des sciences et Techniques de Tunis". He is currently Technologue at "ISET de Bizerte" and he is preparing the PhD degree in Electrical Engineering in "Ecole Nationale d'Ingénieurs de Tunis". His research interests control systems based on classical and advanced approaches.

**Kamel Ben Saad** Was born in 1976 in Tunis, Tunisia. He graduated in 2000 from Ecole Nationale d'Ingénieurs (ENIT). He received the master degree also from ENIT in 2001. He received the PhD degree in Electrical Engineering in 2005 from Ecole Centrale de Lille and Ecole Nationale d'Ingénieurs de Tunis. He is currently Maître-Assistant (Assistant Professor) at the ENIT. His research interests are in the area of machines, classical and intelligent, control.

**Mohamed Benrejeb** Was born in Tunisia in 1950. He obtained the Diploma of "Ingénieur IDN" in 1973, The Master degree of Automatic Control in 1974, the PhD in Automatic Control of the University of Lille in 1976 and the DSc of the same University in 1980. Full Professor at "Ecole Nationale d'Ingénieurs de Tunis" since 1985 and at "Ecole Centrale de Lille" since 2003, his research interests are in the area of analysis and synthesis of complex systems based on classical and non conventional approaches.